

## MGJ, Miniature Guide Rod Cylinder MGJ6-10

Datasheet

### General series information

- Miniature guide rod Cylinder
- Bore sizes (mm): 6, 10
- Strokes up to 20 mm.



Double-acting cylinder, rear boss mount, single piston rod

### Standard specifications

Bore Size	6mm
Stroke	10mm
Auto Switch	None
Lead Wire	05 M Lead Wire (or None in the Case of No Switch)
Number	2 pcs. (Or None in the Case of No Switch)
Pressure medium	Air
Maximum operating pressure	0.7 MPa
Minimum operating pressure	0.15 MPa
Proof pressure	1.05 MPa
Maximum ambient temperature	60 °C
Minimum ambient temperature	- 10 °C
Conform to the European RoHS Directive	Conform
Maximum piston speed	500 mm/s
F040-Typ_of_cush	Rubber bumper at both ends
Minimum piston speed	50 mm/s
Port size	M3
Lubrication	Non-lube
Stroke length tolerance	+ 1.0-0 mm
Thread Tolerance	JIS class 2
Action	Double Acting

Guide size	ø5
Weight	0.032 Kg

# Dimensions

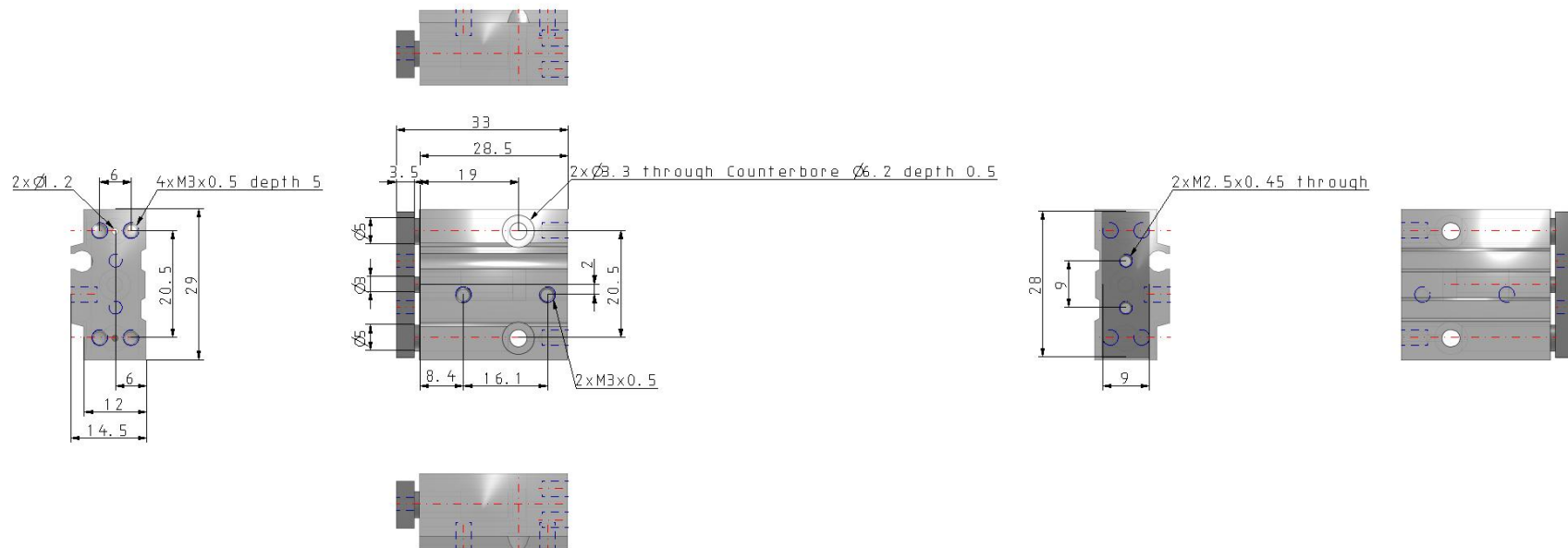

## Constructions

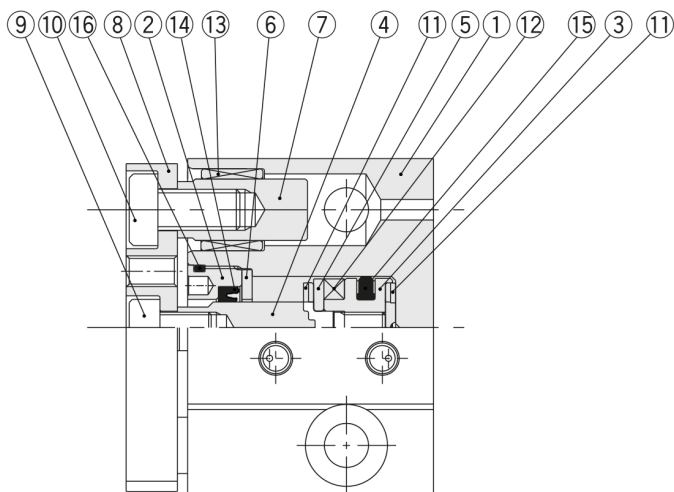

### Parts list

No.	Description	Material	Note
1	Body	Aluminum alloy	Hard anodized
2	Rod cover	Aluminum alloy	Chromated
3	Piston	Aluminum alloy	Chromated
4	Piston rod	Stainless steel	
5	Magnet retainer	Aluminum alloy	Chromated, in case of Ø 6
		Stainless steel	In case of Ø 10
6	Seal retainer	Aluminum alloy	Chromated, in case of Ø 6
		Stainless steel	In case of Ø 10
7	Guide rod	Constructional steel	Hard chromium electroplated
8	Plate	Aluminum alloy	Hard anodized
9	Torque socket head bolt	Constructional steel	Nickel plated, in case of Ø 6
	Hexagon socket head cap screw	Constructional steel	Nickel plated, in case of Ø 10
10	Brazier head hexagon socket bolt	Constructional steel	Nickel plated
11	Bumper	Resin	
12	Magnet	Magnet	
13	Bushing	Sintered oil-impregnated bearing	
14	Rod seal	NBR	
15	Piston seal	NBR	
16	O-ring	NBR	

## Additional information

Catalogue

[MGJ\\_EU.pdf](#)

Operation manuals

[OM\\_MGJ\\_OM0001OEN.pdf](#)