

MXH-Z, Compact Slide Table, Linear Guide

MXH6-15Z

Datasheet

General series information

- Bore sizes: 6, 10, 16, 20 mm
- Special (non-standard) porting option
- Rubber bumpers
- RoHS compliant
- Auto switch capable



Double-acting, single-rod cylinder

Standard specifications

Bore Size	6mm
Stroke	15mm
Auto Switch	No Switch
Lead Wire or Prewired Connector	0.5m (Or None in the Case of No Switch)
Number	2 pcs. (Or None in the Case of No Switch)
Made to Order	None
Pressure medium	Compressed air
Maximum temperature of pressure medium with magnet	60 °C
Minimum temperature of pressure medium with magnet	-10 °C [without condensation]
Maximum operating pressure	0.7 MPa
Minimum operating pressure	0.15 MPa
Proof pressure	1.05 MPa
Maximum ambient temperature with magnet	60 °C
Minimum ambient temperature with magnet	-10 °C [without condensation]
Conform to the European RoHS Directive	Conform
Number of pneumatic connections	2 pcs.
Pneumatic input connection	M5
Mode of operation of drive	Double acting

Theoretical cylinder force, advance stroke (at 0.5 MPa)	14 N
Theoretical cylinder force, return stroke (at 0.5 MPa)	10 N
Maximum piston speed	500 mm/s
Type of cushioning	Rubber bumper
Allowable moment Mp	0,81
Allowable moment My	0,81
Allowable moment Mr	1,4
Allowable kinetic energy	0,0125
Weight	0.075 Kg

Dimensions

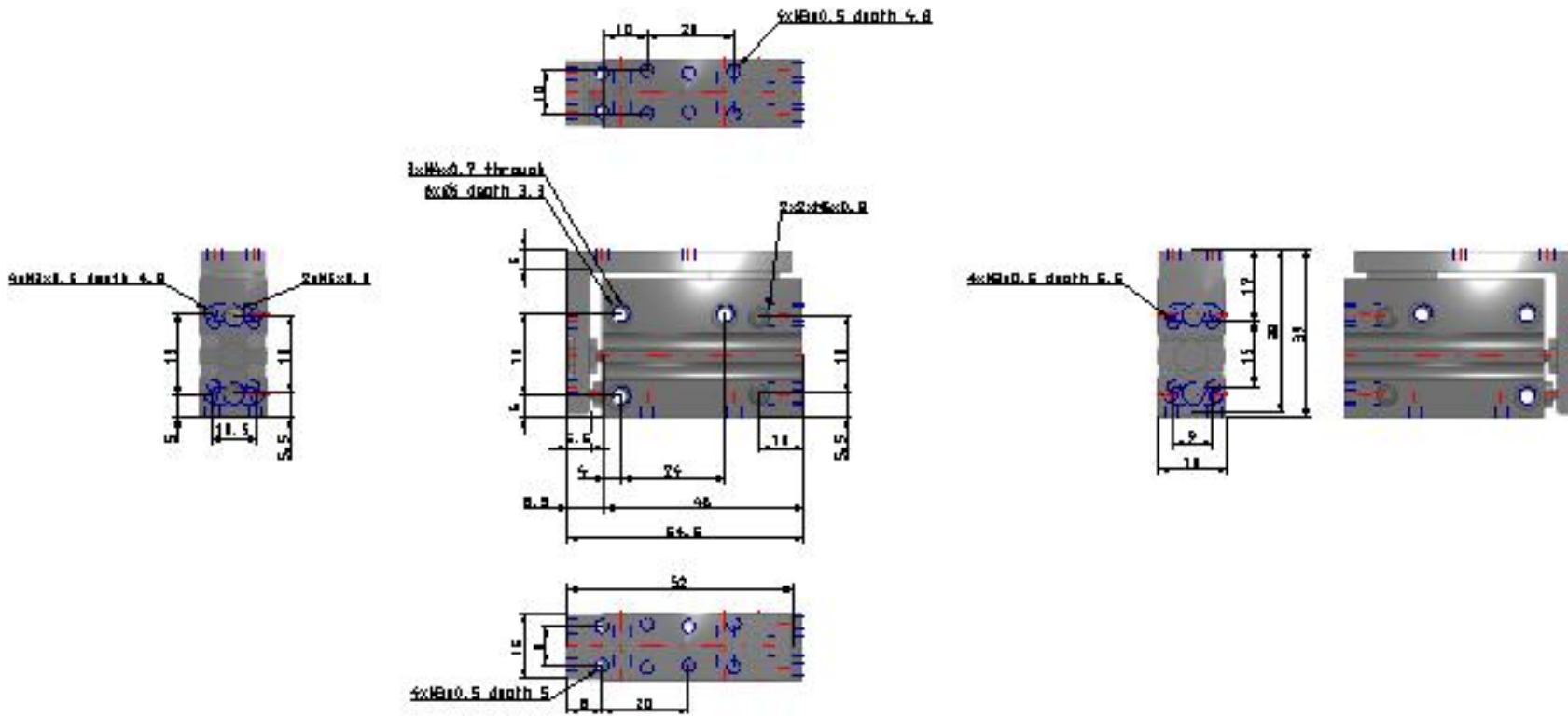

Constructions

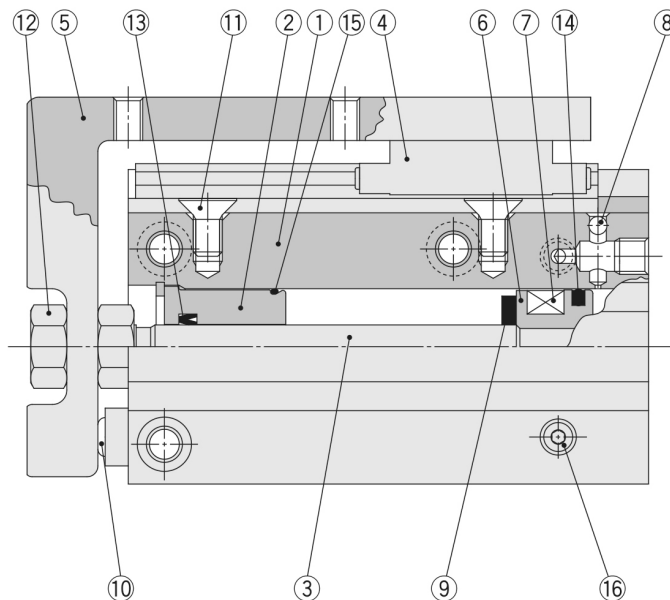

Component Parts

No.	Description	Material	Note
1	Cylinder tube	Aluminium alloy	Hard anodised
2	Rod cover	Aluminium alloy	Hard anodised
3	Piston rod	Stainless steel	
4	Guide	The main parts are made of stainless steel.	
5	Table	Aluminium alloy	Hard anodised
6	Piston	Aluminium alloy	Chromated
7	Magnet	Magnetic material	
8	Steel ball	Carbon steel	
9	Bumper	Urethane	
10	Bumper	Urethane	
11	Countersunk head screw	Carbon steel	Nickel plating
12	Nut	Brass	Nickel plating
13	Rod seal	NBR	
14	Piston seal	NBR	
15	Gasket	NBR	
16	Plug	Carbon steel	Zinc chromated

Note) The MXH series cannot be disassembled.

Additional information

Catalogue

[MXH-Z-A_EU.pdf](#)

Operation manuals

[OM_MXHx_OM0056EN-P.pdf](#)