

## MSQB1-7, Rotary Table Rack & Pinion Type MSQB1A

Datasheet

### General series information

- Compact rotary table, rack-and pinion type
- Sizes: 1, 2, 3, 7
- Universal mounting style
- Wiring and piping can be selected according to mounting conditions
- Angle adjustment range: 0 to 190

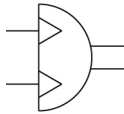

*Semi-rotary actuator, double acting*

### Standard specifications

Clean Series	None
Model	MSQ
Type	B (Basic Type)
Size	1
Port Location	Side Port
Auto Switch	No Switch
Lead Wire or Prewired Connector	0.5m [Or None in the Case of No Switch]
Number	2 pcs. (Or None in the Case of No Switch)
Pressure medium	Compressed air (non-lube)
Maximum temperature of pressure medium	60 °C
Minimum temperature of pressure medium	0 °C
Maximum operating pressure	0.7 MPa
Minimum operating pressure	0.1 MPa
Maximum ambient temperature	60 °C
Minimum ambient temperature	0 °C
Number of pneumatic connections	4 pcs.
Pneumatic input connection	M3
Mode of operation of drive	Double acting

-	0° to 190°
Weight	0.075 Kg

# Dimensions

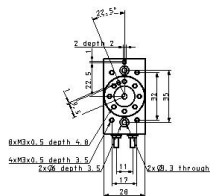
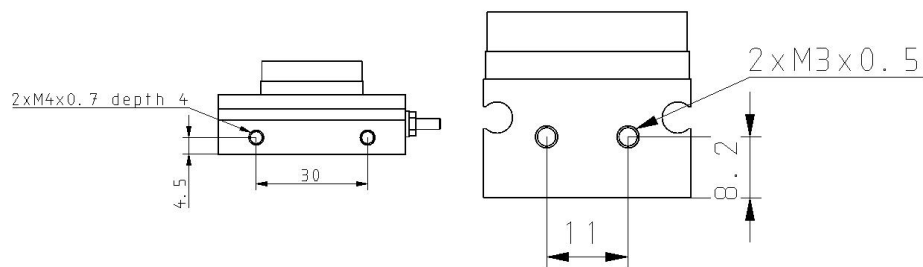
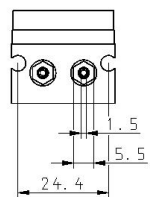
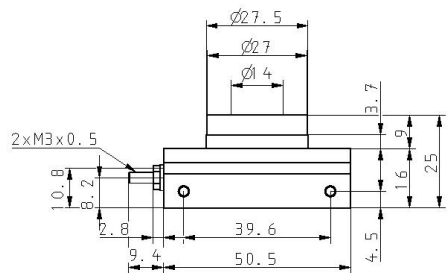
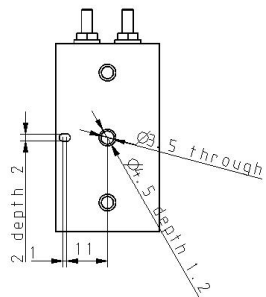

## Constructions

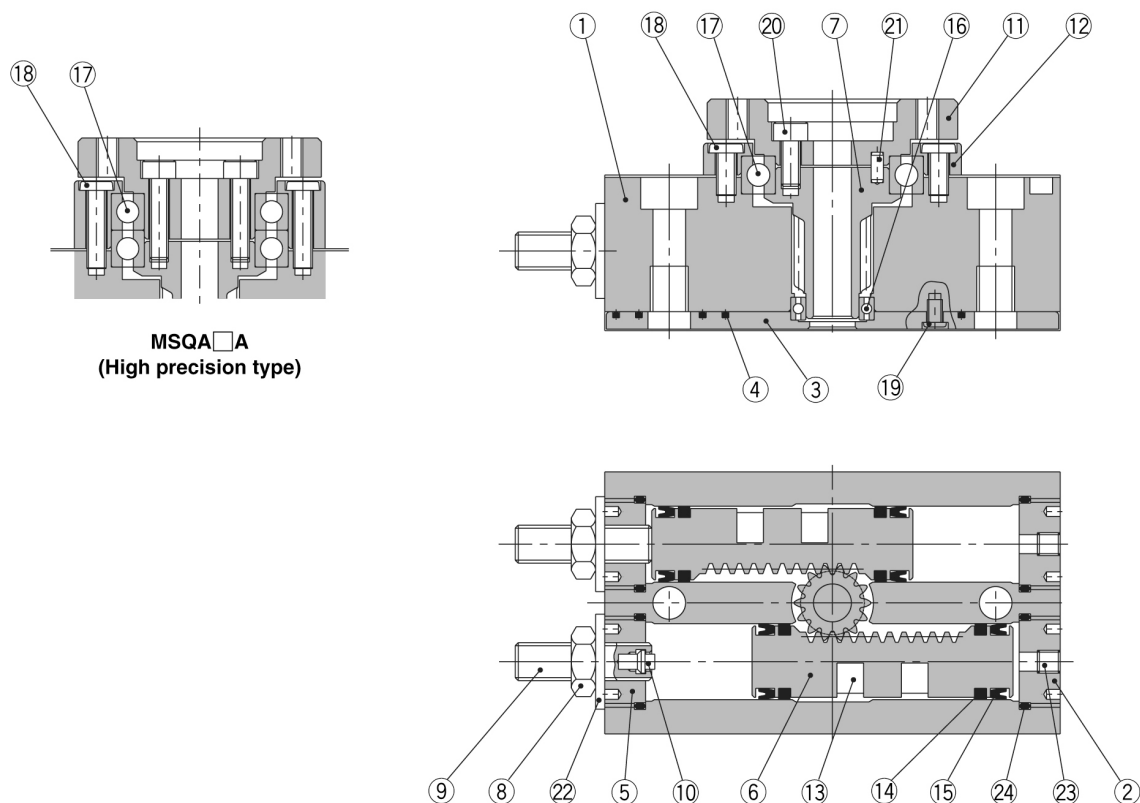

**MSQA□A**  
(High precision type)

### Component parts

No.	Description	Material
1	Body	Aluminium alloy
2	Cover	Aluminium alloy
3	Plate	Aluminium alloy
4	Seal	NBR
5	End cover	Aluminium alloy
6	Piston	Stainless steel
7	Pinion	Chrome molybdenum steel
8	Hexagon nut	Steel wire
9	Adjustment bolt	Steel wire
10	Cushion pad	Size: 3, 7 Rubber material
11	Table	Aluminium alloy
12	Bearing retainer	Aluminium alloy
13	Magnet	Magnetic material
14	Wear ring	Resin

No.	Description	Material
15	Piston seal	NBR
16	Deep groove ball bearing	Bearing steel
17	Basic type	Deep groove ball bearing
	High precision type	Special bearing
18	Round head Philips screw No.0	Basic type Size: 1 to 3
	Round head Philips screw	
	Round head Philips screw	High precision type
19	Round head Philips screw No.0	Steel wire
20	Hexagon socket head set bolt	Stainless steel
21	Parallel pin	Carbon steel
22	Seal washer	NBR
23	Hexagon socket head set screw	Stainless steel
24	O-ring	NBR

\*23 The hexagon socket head set screws are tightened at different positions depending on the position of the connecting port.

## Additional information

Catalogue

[MSQ\\_EU.pdf](#)

Operation manuals

[OM\\_MSQ\\_OM0002EN-B.pdf](#)