

CP96S(D), ISO 15552 Cylinder, Double Acting, Single/Double Rod with Air cushion on both ends and Bumper cushion CP96SDB63-100C

Datasheet

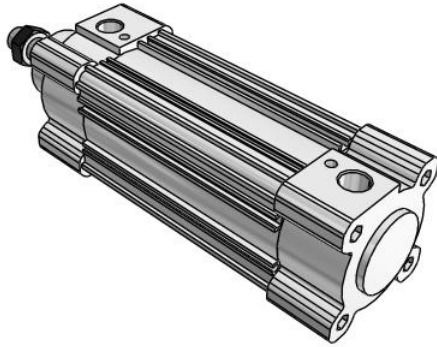

General series information

- Double acting, standard type, single or double rod with Air cushion on both ends and Bumper cushion
- Bore sizes (mm): 32, 40, 50, 63, 80, 100
- Standard stroke up to 2000mm
- Auto switch capable

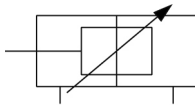

Double-acting cylinder with cushioning adjustable at both ends, single piston rod

Standard specifications

Magnet	D (Built-in)
Mounting	B (Basic)
Bore Size	Ø63 mm
Stroke	100
Rod Boot	w/o Rod Boot
Rod	Single Rod
Auto Switch	No Switch
Lead Wire or Prewired Connector	0.5m [Or None in the Case of No Switch]
Number	2 pcs. [Or None in the Case of No Switch]
Rod End Options	None
Temperature Resistance	None
Heavy Duty Scraper	None
Tie Rod	None
Fluororubber Seal	None
Coil Scraper	None
Made of Stainless Steel (-XC68)	None
Made of Stainless Steel (-XC65)	None
Pressure medium	Compressed air
Maximum temperature of pressure medium with magnet	60 °C

Minimum temperature of pressure medium with magnet	-10 °C (no freezing)
Maximum operating pressure	1.0 MPa
Minimum operating pressure	0.05 MPa
Proof pressure	1.5 MPa
Maximum ambient temperature with magnet	60 °C
Minimum ambient temperature with magnet	-10 °C (no freezing)
Number of pneumatic connections	2 pcs.
Pneumatic input connection	G 3/8
Pneumatic exhaust connection	G 3/8
Mode of operation of drive	Double acting
Theoretical cylinder force, advance stroke (at 0.5 MPa)	1,559 N
Theoretical cylinder force, return stroke (at 0.5 MPa)	1,402 N
Maximum piston speed	1,000 mm/s
Piston rod end	Male thread
Male thread of rod end	M16 x 1.5
Minimum piston speed	50 mm/s
Weight	2.120 Kg

Constructions



Component Parts

No.	Description	Material	Note
1	Rod cover	Aluminium die-cast	
2	Head cover	Aluminium die-cast	
3	Cylinder tube	Aluminium alloy	
4	Piston rod	Carbon steel	
5	Piston	Aluminium alloy	Ø 32 to Ø 63
		Aluminium die-cast	Ø 80, Ø 100
6	Cushion ring A	Aluminium alloy	
7	Cushion ring B	Aluminium alloy	
8	Cushion seal holder	Aluminium alloy	
9	Tie-rod	Carbon steel	
10	Tie-rod nut	Steel	
11	Flat washer	Steel	Ø 80, Ø 100
12	Rod end nut	Steel	
13	Cushion valve	Resin	
14	Bushing	Bearing alloy	
15	Cushion seal	Urethane	
16	Bumper	Urethane	
17	Wear ring	Resin	
18	Piston seal	NBR	
19	Rod seal	NBR	
20	Cylinder tube gasket	NBR	
21	Cushion valve seal	NBR	
22	Magnet		

Replacement Parts/Seal Kit (Single rod)

Bore size [mm]	Kit no.	Contents
32	CS95-32	Kits include items 15, 17 to 20.
40	CS95-40	
50	CS95-50	
63	CS95-63	
80	CS95-80	
100	CS96-100	

Seal Kit (Double rod)

Bore size [mm]	Kit no.	Contents
32	CS95W-32	Kits include items 15, 18 to 20.
40	CS95W-40	
50	CS95W-50	
63	CS95W-63	
80	CS95W-80	
100	CS96W-100	

Additional information

Catalogue

[CP96-Bb_EU.pdf](#)

Operation manuals

[OM_CP96-C_OM0002QEN-A.pdf](#)