

ZH-A, Vacuum Ejector, Box Style/Body Ported Style, Metric

ZH07DSA-06-06-06

Datasheet

General series information

- One-touch fittings: Ø 6, 8, 10 and 12 mm. Screw-in connections: 1/8" to 1/2" (Rc/G).

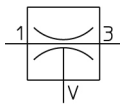

Vacuum ejector

Standard specifications

Nozzle Diameter	07 (Ø 0.7 mm)
Model	D (Body Ported Style)
Vacuum Pressure	S [-90 kPa; -89 kPa (Box Style)]
Port SUP.	06 (One-touch Fitting Ø6 mm)
Port VAC.	06 (One-touch Fitting Ø6)
Port EXH.	06 (One-touch Fitting Ø6)
Accessories	W/ Bracket - W/o Silencer (or None in the Case of Box Style)
Pressure medium	Air
Maximum temperature of pressure medium	50 °C
Minimum temperature of pressure medium	-5 °C
Maximum ambient temperature	50 °C
Minimum ambient temperature	-5 °C
Pneumatic input connection	One-touch Ø 6
Pneumatic exhaust connection	One-touch Ø 6
Flow rate	12 l/min (ANR)
Usable tubing material	Soft nylon;Nylon;Polyurethane
Pneumatic vacuum connection	One-touch Ø 6
Maximum Vacuum	-90 kPa
Nozzle nominal size [mm]	0.7 mm
Weight	0.012 Kg

Dimensions

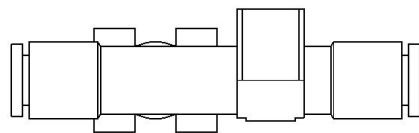
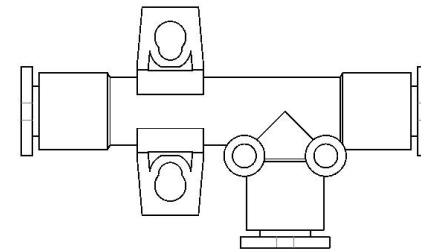
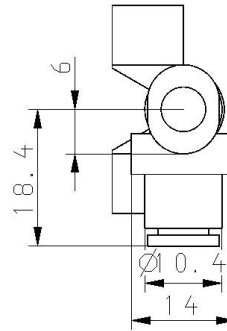
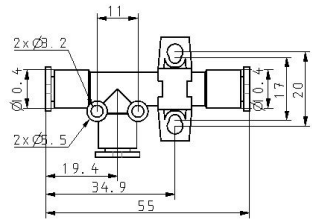
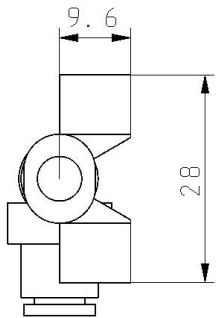
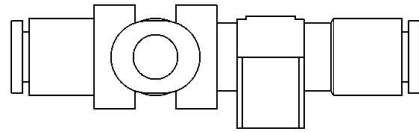

Constructions

Body ported type

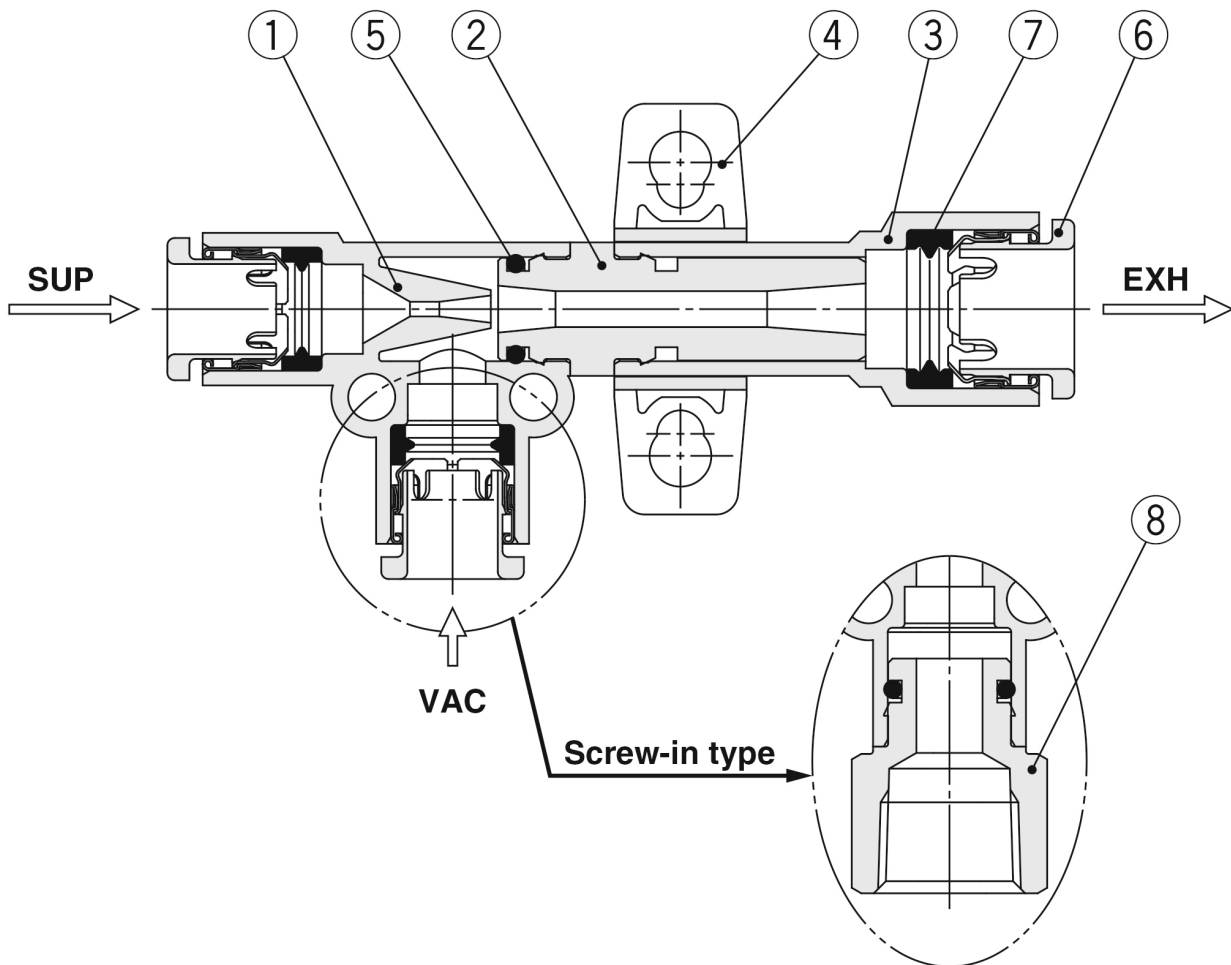

Component Parts

No.	Description	Material	Note
1	Body	PBT	
2	Diffuser	PPS	Type S: Brown, Type L: Black
3	Adapter	PBT	
4	Standard bracket	PBT	Detachable (Accessory)
5	O-ring	NBR	Grease applied
6	Cassette	—	
7	Seal	NBR	Grease applied
8	Screw-in stud	Brass	Electroless nickel plating

Additional information

Catalogue	ZH-C_EU.pdf
Operation manuals	OM_ZH_OM00401EN.pdf