

AF20-D to AF60-D, Air Filter AF30-F03D-D

Datasheet

General series information

- ISO 8573-1:2010 compliant
- Nominal filtration rating 5 µm
- Maximum flow rate up to 12500 l/min (ANR, 0.7MPa).

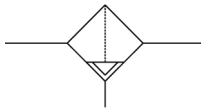

Filter with automatic drain

Standard specifications

Body Size	30
Thread	F (G)
Port Size	03 (3/8)
Mounting	Standard
Float type auto drain	D [Float Type Auto Drain (N.O.)]
Bowl type	Standard (Polycarbonate Bowl)
Drain Port	Standard
Flow Direction	Left to Right
Drain Cock w/Barb Fitting	None
Pressure Unit	Name Plate and Pressure Gauge: MPa
Air purity class	[6:8:4]
Pressure medium	Air
Maximum temperature of pressure medium	60 °C
Minimum temperature of pressure medium	-5 °C (with no freezing)
Maximum operating pressure	1.0 MPa
Minimum operating pressure	0.05 MPa
Proof pressure	1.5 MPa
Maximum ambient temperature	60 °C
Minimum ambient temperature	-5 °C (with no freezing)
Conform to the European RoHS Directive	Conform

Bowl Material	Polycarbonate
Bowl Guard	Polycarbonate
Drain Capacity	25 cm ³
Element nominal filtration rating	5 µm
ISO 8573 compliant	Yes
Max. Flow rate (inlet pressure = 1.0 MPa)	4000 l/min
Weight	0.212 Kg

Dimensions

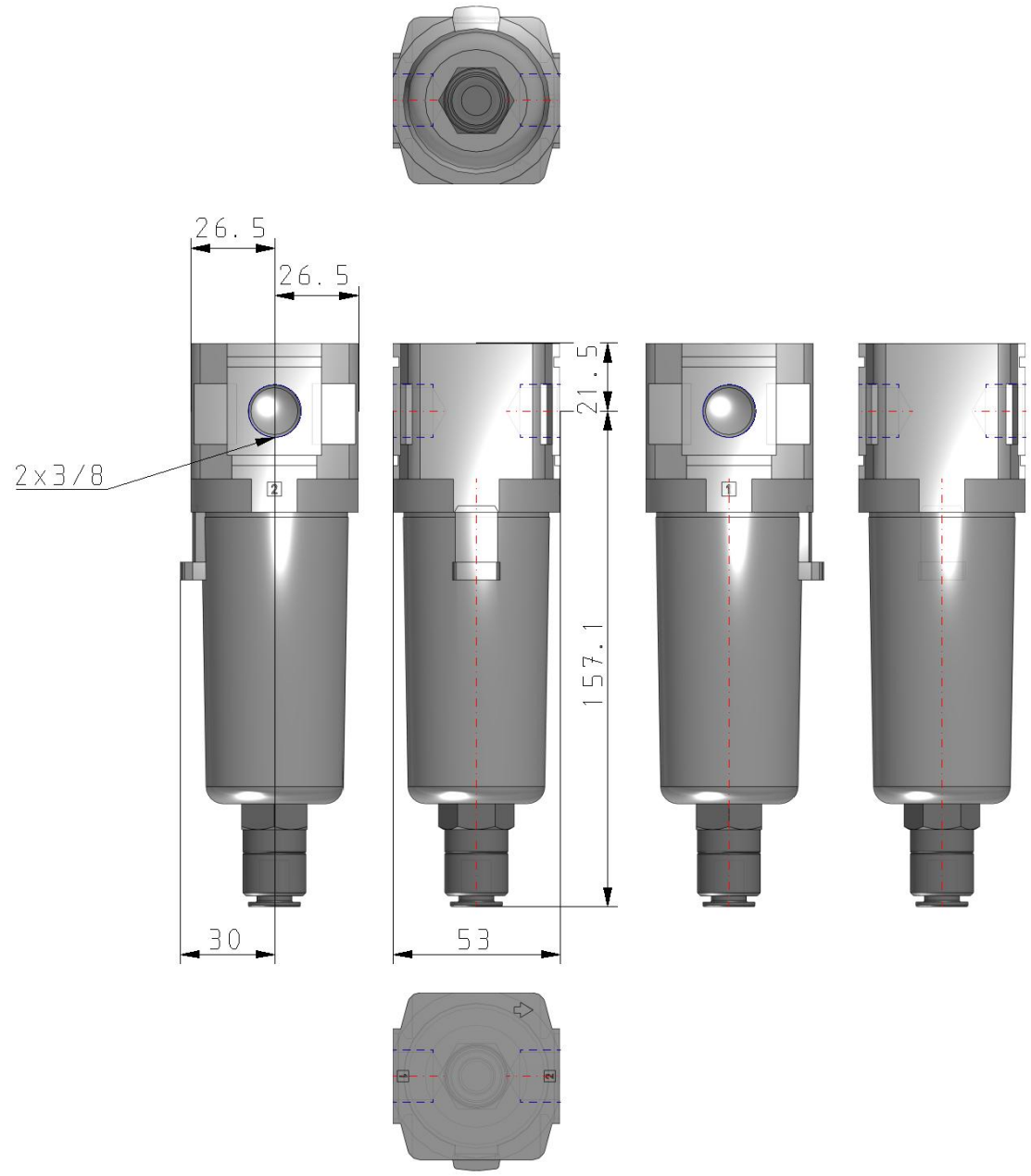

Specifications are subject to change without prior notice and any obligation on the part of the manufacturer.

Additional information

Catalogue

[ACD-D_EU.pdf](#)

Operation manuals

[OM_AF20-60-D_OMX0052EN-D.pdf](#)