

## IR1000/2000/3000, Precision Regulator IR3010-F03

Datasheet

### General series information

- Precision regulator
- Regulating pressure range (MPa): 0.005 to 0.8 depending on model
- Compact and lightweight
- Bracket & pressure gauge can be mounted on either the front or back
- 2 air operated models.

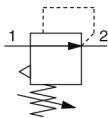

Pressure control valve, relieving pressure regulator, adjustable

### Standard specifications

Body Size	3 (IR3000)
Type of Setting	0 (Basic [Handle])
Set Pressure	1 (0.01~0.4 MPa [IR1000/2000] or 0.01~0.4 MPa [IR3000])
Thread	F [G(PF)]
Port Size	03 (3/8 [IR3000 Only])
Accessory	None
Suffix 1	Standard
Suffix 2	None
Made to Order	None
Switch Specifications	None
Pressure medium	Air
Maximum temperature of pressure medium	60 °C
Minimum temperature of pressure medium	-5 °C [with no freezing]
Maximum operating pressure	1.0 MPa
Minimum operating pressure	+0.1 Mpa
Maximum ambient temperature	60 °C;60 °C
Maximum ambient temperature with magnet	-5 °C [with no freezing];-5 °C [with no freezing]
Approvals	No need

Sensitivity	Within 0.2% of full span
Repeatability	Within 0.5% of full span
Set pressure range	0.01 - 0.4 MPa
Linearity	Within 1% of full span
Air consumption (At supply pressure of 1.0 MPa)	11.5 l/min (ANR) or less
Input signal pressure	0.01 - 0.8 Mpa
Weight	0.680 Kg

# Dimensions

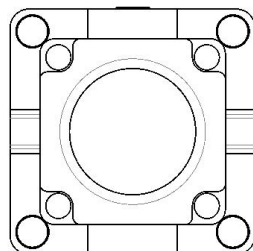
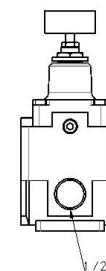
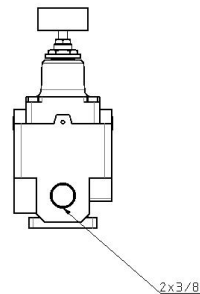
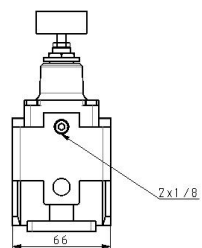
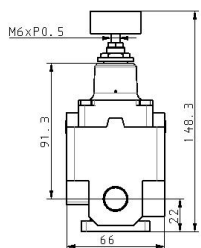
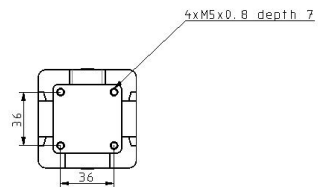

# Constructions

## Construction

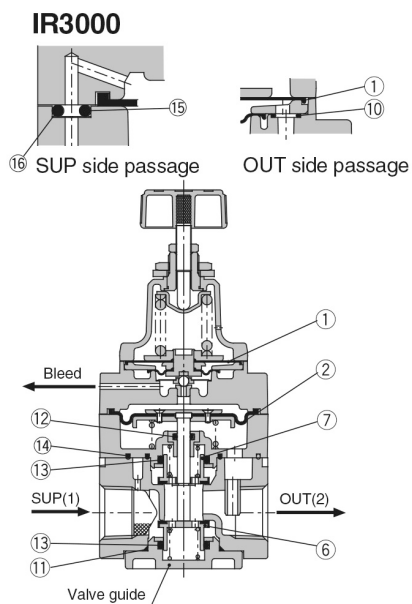

### Replacement Parts

No.	Description	Material	IR30□0	
			Part no.	Qty.
1	Diaphragm assembly	NBR, other	P362020-2	1
2	Diaphragm assembly	NBR, other	P362030-1	1
3	Diaphragm	NBR, other	—	—
4	Valve	Stainless steel, NBR	—	—
5	Valve	Stainless steel, NBR	—	—
6	Valve	Brass, NBR	P36203009#1	1
7	Valve	Brass, NBR	P36203010#1	1
8	Damper	NBR, other	—	—
9	O-ring	H-NBR	—	—
10	O-ring	NBR	ø4.5 x 1	1
11	O-ring	NBR	ø27.8 x 1.5	1
12	O-ring	NBR	JISB2401P5 <small>Note)</small>	1
13	O-ring	NBR	JISB2401P16 <small>Note)</small>	2
14	Seal (A)	NBR	P36203015	1
15	Seal (B)	NBR	P36203016	3
16	Fixed throttle	Stainless steel	P36203017	1
Repair kit no. (A set of above nos. ① to ⑮.)			KT-IR3000	



Note) Use mini-flick type.

## Additional information

Catalogue	<a href="#">IR1000-2000-3000-B_EU.pdf</a>
Operation manuals	<a href="#">OM_IR30-OM00002EN-F.pdf</a> <a href="#">IR10-OM00006_GB.pdf</a> <a href="#">OM_IR20-OM00004EN-E.pdf</a> <a href="#">OM_IR10_OM00002EN-E.pdf</a> <a href="#">OM_IR20_OM00002EN-F.pdf</a> <a href="#">OM_IR30_OM00004EN-F.pdf</a>