

# IR1000/2000/3000-A, Precision Regulator IR2010-F02-A

Datasheet

## General series information

- Lightweight.
- Addition of bottom and front exhaust.
- Precision regulator, with repeatability  $\pm 0.5\%$  (full span). Sensitivity:  $0.2\%$  (full span).
- Max. supply pressure: 1.0 MPa.

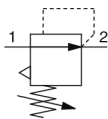

Pressure control valve, relieving pressure regulator, adjustable

## Standard specifications

Body Size	2
Set pressure	1 (0.01 to 0.4 MPa)
Exhaust Direction	0 (Bottom Exhaust)
Thread	F (G)
Port Size	02 (1/4)
Option	None
Semi-standard	None
Pressure medium	Air
Maximum temperature of pressure medium	60 °C
Minimum temperature of pressure medium	-5 °C [with no freezing]
Proof pressure	1.5 MPa
Maximum ambient temperature	60 °C
Minimum ambient temperature	-5 °C [with no freezing]
Sensitivity	Within 0.2% of full span
Repeatability	Within 0.5% of full span
Set pressure range	0.01 to 0.4 MPa
Air consumption (At supply pressure of 1.0 MPa)	1 l/min (ANR) or less
Max. supply pressure	1.0 MPa
Min. supply pressure	0.05 MPa

Weight

0.250 Kg

---

# Dimensions

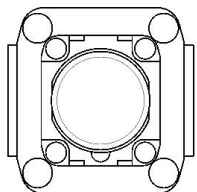
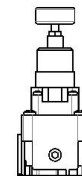
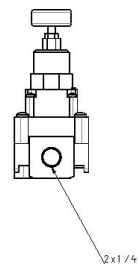
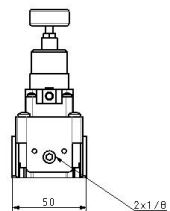
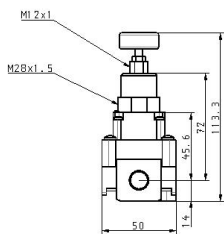
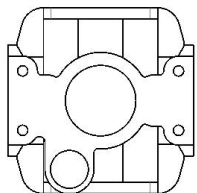

## Constructions

### Basic type (Knob): IR20□0-A

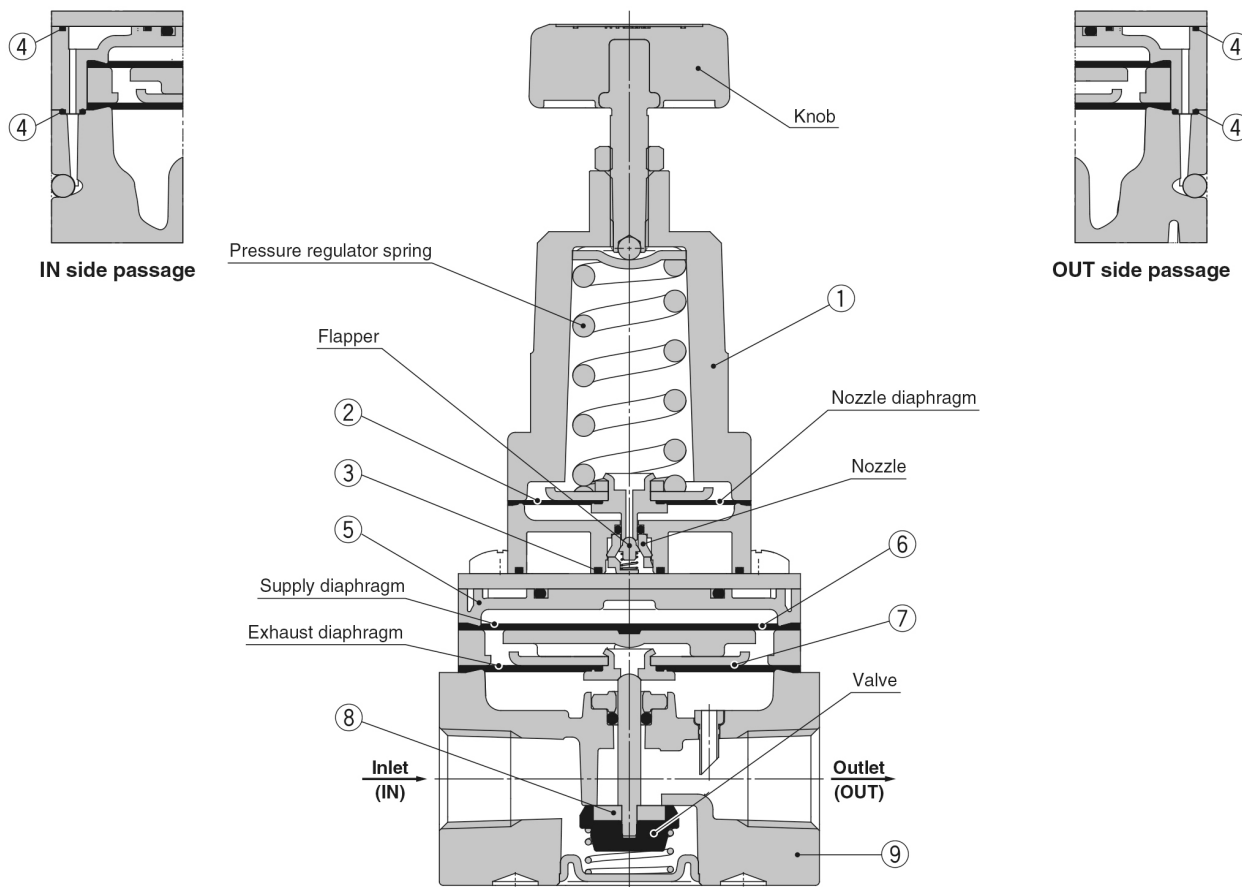

### Component Parts

No.	Description	Material		
		IR1000-A	IR2000-A	IR3000-A
1	Bonnet	Aluminium die-casted		
2	Nozzle diaphragm assembly	Aluminium, Weather resistant NBR		
3	Seal	HNBR		
4	Seal	NBR		
5	Diaphragm spacer	Polyacetal		
6	Supply diaphragm	Weather resistant NBR		—
7	Exhaust diaphragm assembly	Steel, Aluminium, Weather resistant NBR		Aluminium, Weather resistant NBR, HNBR
8	Valve assembly	Stainless steel, Aluminium, HNBR		Aluminium, HNBR
9	Body	Aluminium die-casted		

## Additional information

Catalogue	<a href="#">IR000A-Aa_EU.pdf</a>
Installation manuals	<a href="#">IM_IRx000-A_SMW54EN.pdf</a>
Operation manuals	<a href="#">OM_IR10_OM00008EN.pdf</a> <a href="#">OM_IRx_OMT0020EN.pdf</a>