

VT307, 3 Port Direct Operated Poppet, All Types VT307K-5DZ1-01F-Q

Datasheet

General series information

- Wide variety of valve options .
- Low Power Consumption.
- Universal porting type.
- Same mounting dimensions as the current product in both types (body ported and for manifold type).
- Low concentration ozone resistant: HNBR rubber seal.
- RoHS and CE compliant.

Standard specifications

Body	T (Body Ported)
Valve specification	Standard
Pressure specifications	K (High-pressure type [1 MPa])
Rated Voltage	5 (24V DC)
Electrical Entry	D (DIN connector [with connector])
Indicator light and surge voltage suppressor	Z (W/indicator light and surge suppressor)
Port Size	01 (1/8 [6A])
Thread	F (G [PF])
Option	None
CE Marked	Q (CE Marked)
Pressure medium	Air
Maximum temperature of pressure medium	50 °C
Minimum temperature of pressure medium	-10 °C (No freezing)
Maximum ambient temperature	50 °C
Minimum ambient temperature	-10 °C (No freezing)
Protection class with connector	Dustproof
Function in normal position	Closed

Type of piloting	Directly
Valve return	Mechanical spring
Sealing principle	Soft seal
Weight	0.150 Kg

Dimensions

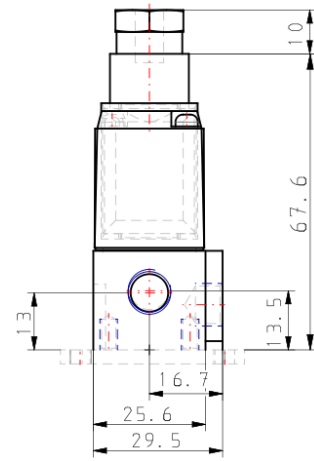
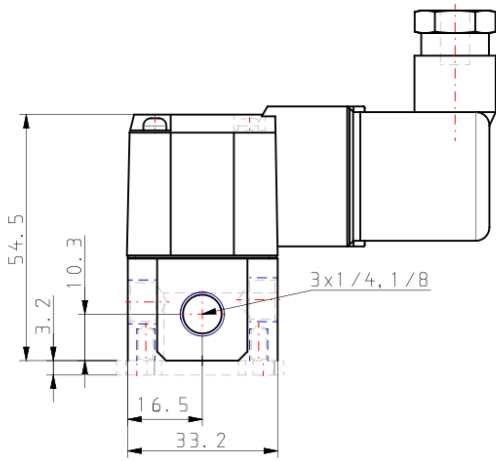
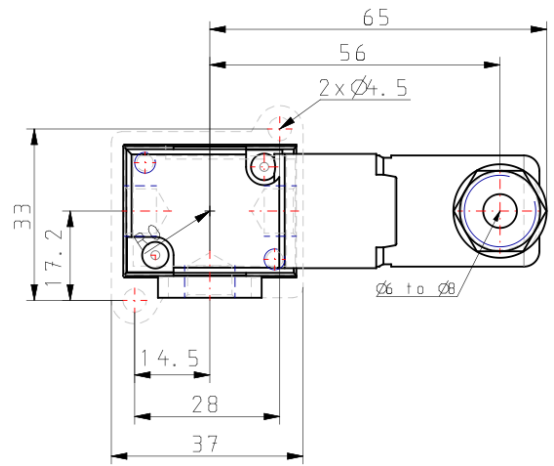
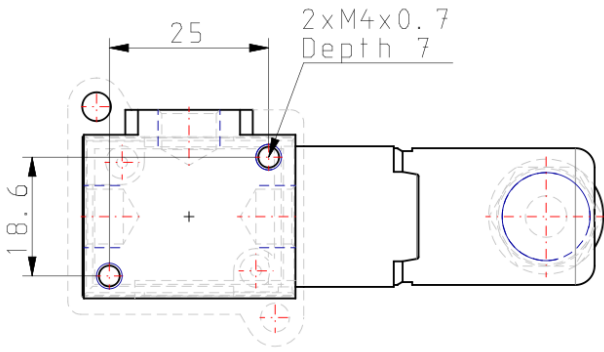

Additional information

Catalogue	VT_A_EU.pdf
Declaration of conformity	newDoC_VT307N_TF1Y176EN.pdf newDoC_New_VT307_TF1V163EN.pdf DoC_NewVT307_TFQ0001-A.pdf
Installation manuals	IM_VT307_TF2Z546EN.pdf
Operation manuals	OM_NewVT307_OMQ0002EN-B.pdf