

AC20A-D to AC60A-D Filter Regulator + Lubricator AC20A-F01G-D

Datasheet

General series information

- ISO 8573-1:2010 compliant
- Port Size: 1/8, 1/4, 3/8, 1/2, 3/4, 1
- Body size: 20, 30, 40, 50, 60.

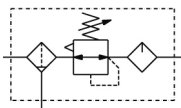

Air combination. Air filter, regulator and Lubricator

Standard specifications

Body Size	20
Thread	F (G)
Port	01 (1/8)
Float type auto drain	Without Auto drain
Pressure gauge /Digital pressure switch	G (Round Pressure Gauge w/Limit Indicator)
Residual Pressure Relief 3 Port Valve	Without
Set pressure	Standard (0.05 to 0.85 MPa)
Bowl type +Drain Cock for Lubricator	Standard (Polycarbonate Bowl + Lubricator without Drain Cock)
Filter Regulator Drain Port	Standard
Exhaust Mechanism	Relieving
Flow Direction	Standard (Flow Direction: Left->Right)
Drain Cock w/Barb Fitting	Without Barb Fitting
Pressure Units	Standard (Name Plate, Caution Plate for Bowl, and Pressure Gauge: MPa)
Pressure medium	Air
Maximum temperature of pressure medium	60 °C
Minimum temperature of pressure medium	-5 °C (with no freezing)
Maximum operating pressure	1.0 MPa
Proof pressure	1.5 MPa
Maximum ambient temperature	60 °C

Minimum ambient temperature	-5 °C (with no freezing)
Conform to the European RoHS Directive	Conform
Approvals	No need
Drain Capacity	8 cm ³
Oil capacity	25 cm ³
Max. Flow rate (inlet pressure = 1.0 MPa)	1600 l/min
Weight	0.363 Kg

Dimensions

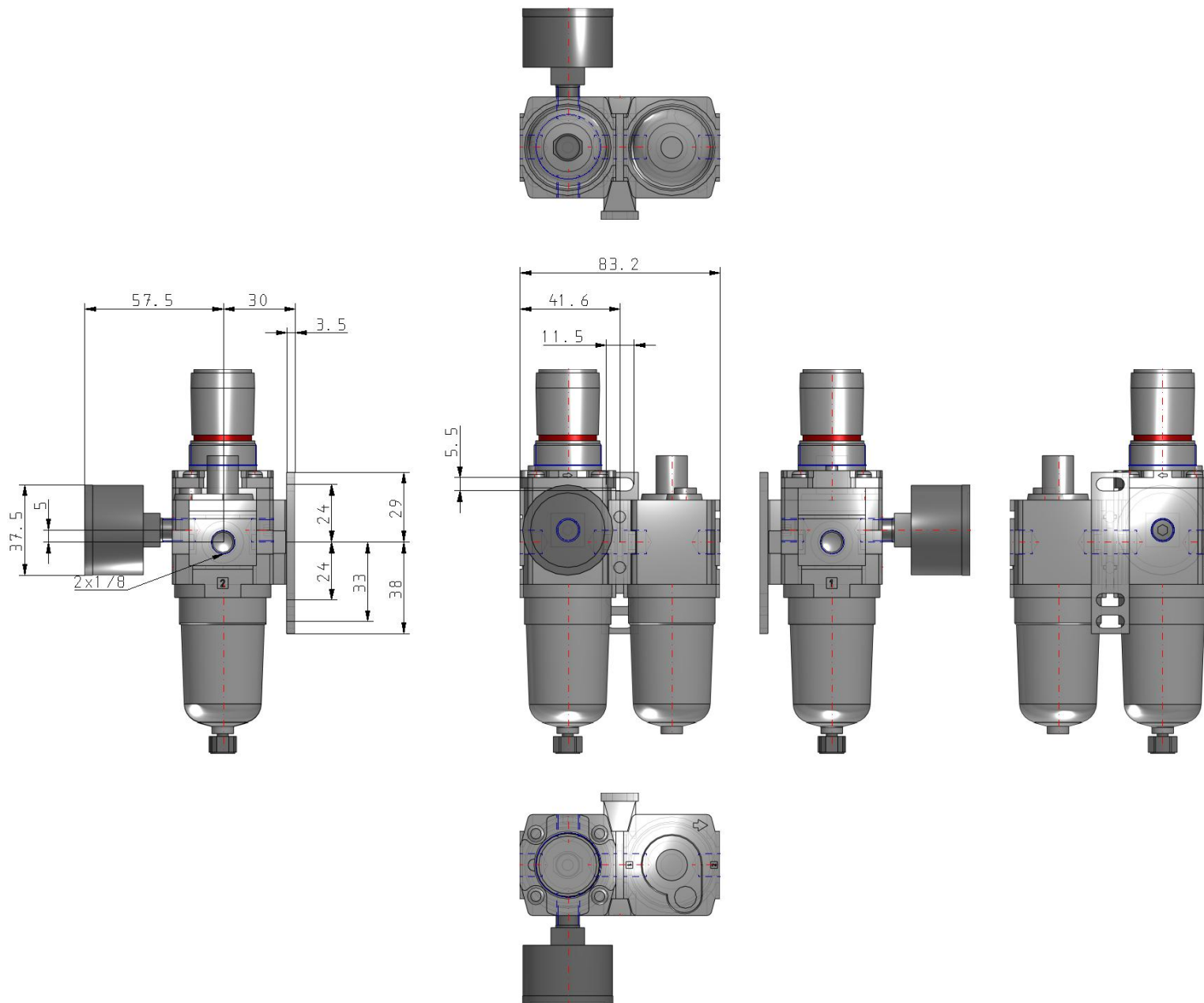

Specifications are subject to change without prior notice and any obligation on the part of the manufacturer.

Additional information

Catalogue

[ACD-D_EU.pdf](#)