

C(D)RB2*W10~40-Z, Rotary Actuator, New Vane Style CDRB2BW20-270SZ

Datasheet

General series information

- Standard type.
- Piping ports are located on the flat surface.
- Many variations of shaft-end shape (6 types).

Standard specifications

Magnet	D (Built-in)
Mounting	B (Basic)
Standard Shaft Type	W (Double Shaft with Single Flat)
Angle Adjusting Unit	None
Size	20 mm
Rotation Angle - Vane	270S (Angle: 270 Single Vane)
Port	Side
Auto Switch	No Switch
Lead Wire or Prewired Connector	0.5m (Or None in the Case of No Switch)
Number	2 pcs. (Or None in the Case of No Switch)
Pressure medium	Air (Non-lube)
Maximum temperature of pressure medium	60 °C
Minimum temperature of pressure medium	5 °C
Maximum ambient temperature	60 °C
Minimum ambient temperature	5 °C
Number of pneumatic connections	2 pcs.
Geometric form of the piston rod	Single rod
Weight	0.136 Kg

Dimensions

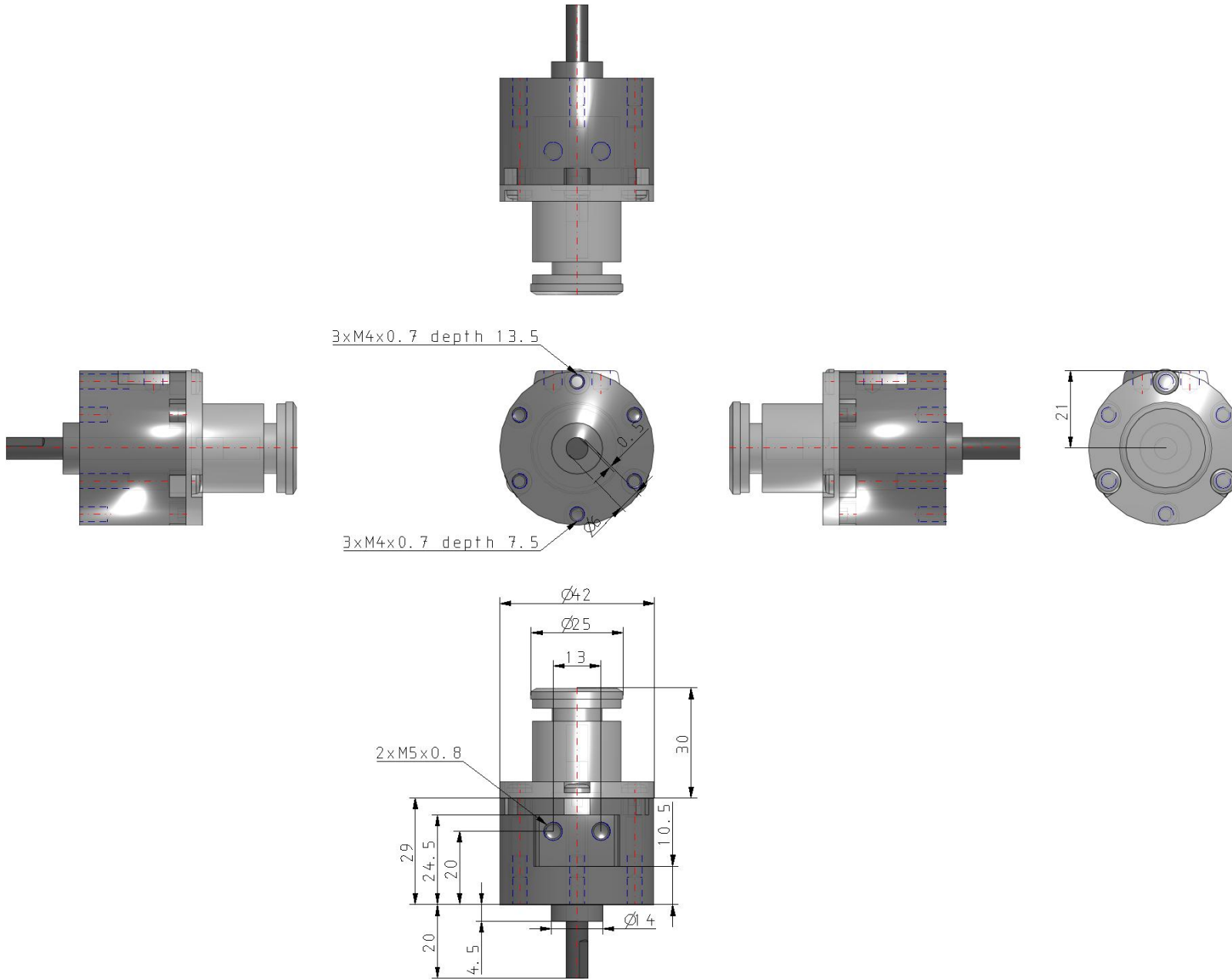

Specifications are subject to change without prior notice and any obligation on the part of the manufacturer.

Additional information

Catalogue

[CRB2-C_EU.pdf](#)

Operation manuals

[OM_CRB2_OM00001EN-B.pdf](#)