

ZK2*A, Vacuum Unit, Ejector System, Single Unit ZK2A15K5RWA-08

Datasheet

General series information

- Dual 2 port valve (Release valve/Supply valve).
- Efficient 2-stage ejector.
- Pressure sensor / switch variations with energy-saving function available.

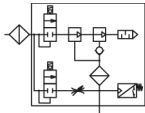

Dual stage modular ejector - with valves and switch

Standard specifications

Body type	A (Single Unit - Silencer Exhaust)
Nominal Nozzle Size	15 (ø1.5)
Supply Valve / Release Valve	K (N.C. / N.C.)
Rated Voltage	5 (24 VDC)
Pressure Sensor/Digital Pressure Switch for Vacuum Spec.	R (Digital Pressure Switch for Vacuum with Energy Saving Function / 100 to -100 kPa / PNP 1 Output / Unit Selection Function)
Supply Valve/Release Valve/Digital Pressure Switch for Vacuum Connector Spec.	W (With Lead Wire for Switch with Energy Saving Function)
Vacuum (V) Port	08 [ø8 One-touch Fitting (Metric)]
Bracket	None
Individual Release Pressure Supply	None
Screwdriver Operation Type Long Lock Nut	None
Vacuum Break Flow Adjustment	None
Exhaust Interference Prevention Valve	None
Pressure medium	Air
Proof pressure	500 kPa
Conform to the European RoHS Directive	Conform
Element nominal filtration rating	30 µm
Repeatability	±0.2 % F.S. ±1 digit
Set pressure range	-105 - 105 kPa

Current consumption	40 mA or less
Applicable fluid	Air
Rated pressure range	-100 - 100 kPa
Power supply voltage	12 to 24 VDC $\pm 10\%$, Ripple (p-p) 10 % or less (Protected against reverse connection)
Switch output	PNP open collector OUT1: General purpose, OUT2: Valve control
Supply pressure range (MPa)	0.3 - 0.6 MPa
Noise level	76 dB
Standard supply pressure	0.4 MPa
Maximum vacuum pressure	-91 kPa
Air consumption	90 l/min
Operating temperature range	5 - 50 °C
Vibration resistance	20 m/s ²
Impact resistance	100 m/s ²
Smallest settable increment	0.1 kPa
Display	3 1/2 digit, 7-segment LED, Colour display (Red)
Display accuracy	$\pm 2\%$ F.S. ± 1 digit (Ambient temperature at 25 ± 3 °C)
Indicator light	Lights up when output is turned ON. OUT1: Green, OUT2: Red
Insulation resistance	50 M Ω or more (500 VDC measured via megohmmeter) between terminals and housing
Switch output Max. applied voltage	26.4 VDC
Valve type of actuation	Supply valve: N.C. Release valve: N.C.
Valve configuration	Pilot operated dual 2-port
Valve operating pressure range	0.3 - 0.6 MPa
Valve construction	Popper seal
Valve rated voltage	24 VDC
Valve power consumption	0.4 W
Valve lead wire (ZK2-LV**-A)	Cross section: 0.2 mm ² (AWG24) Insulator O.D.: 1.4 mm
Suction filter, Filtration area	510 mm ²
Switch output max. load current	80 mA
Switch output residual voltage	2 V or less (at load current of 80 mA)
Switch output response time	2.5 ms or less (with anti-chattering function: 20, 100, 500, 1000, 2000 ms)
Switch output short circuit protection	Yes
Hysteresis	Variable from 0
Switch temperature range	5 - 50 °C
Switch withstand voltage	1000 VAC for 1 minute between terminals and housing
Switch temperature characteristics	$\pm 2\%$ F.S. (at 25 °C in an operating temperature range of 5 and 50 °C)
Switch lead wire	Cable: 5 cores \varnothing 3.5, 2 m Cross section: 0.15 mm ² (AWG26) Insulator O.D.: 1.0 mm
Max. suction flow, Silencer exhaust/Complex exhaust	67 l/min
Enclosure	IP40
Weight	0.200 Kg

Dimensions

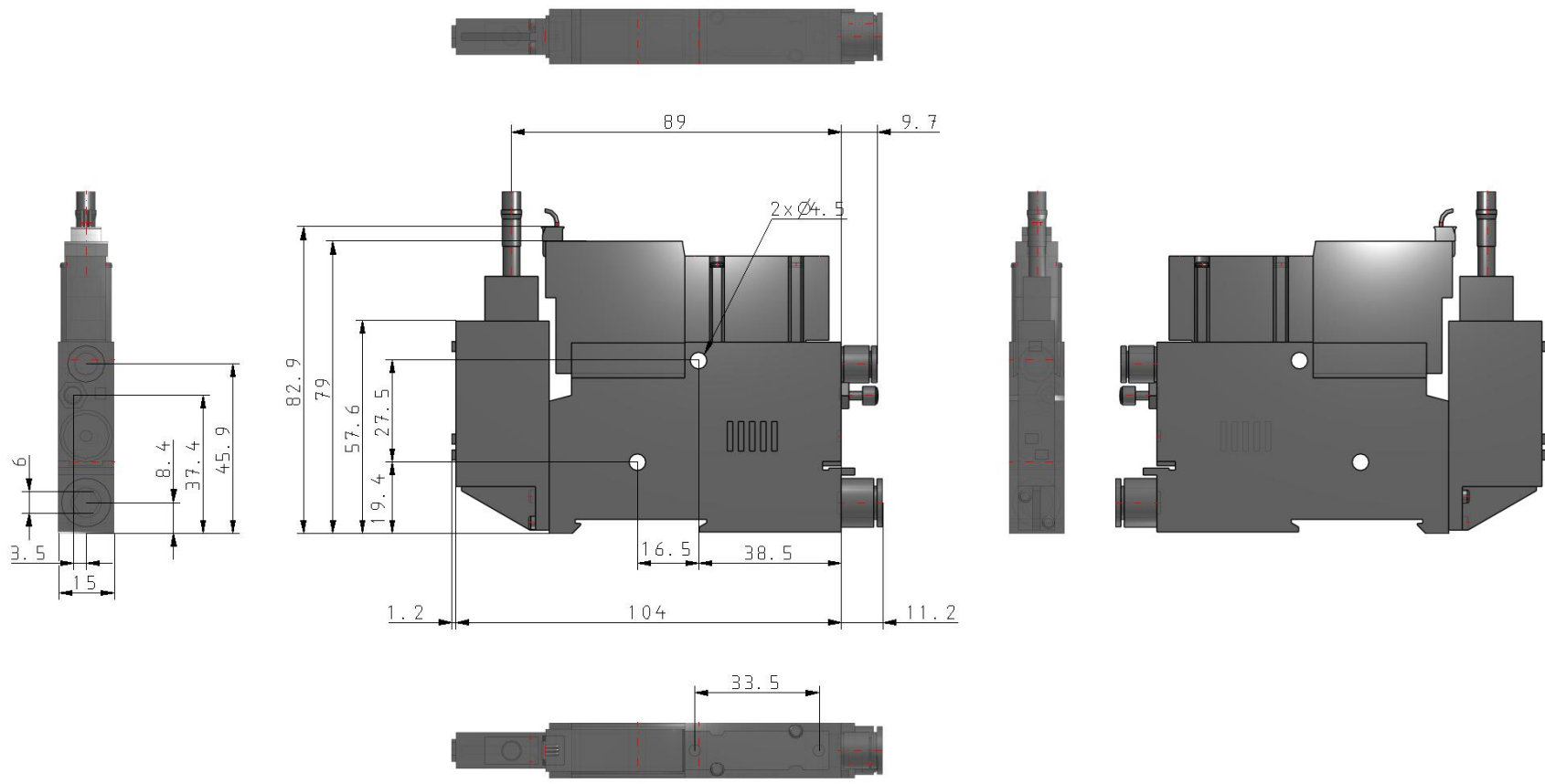

Constructions

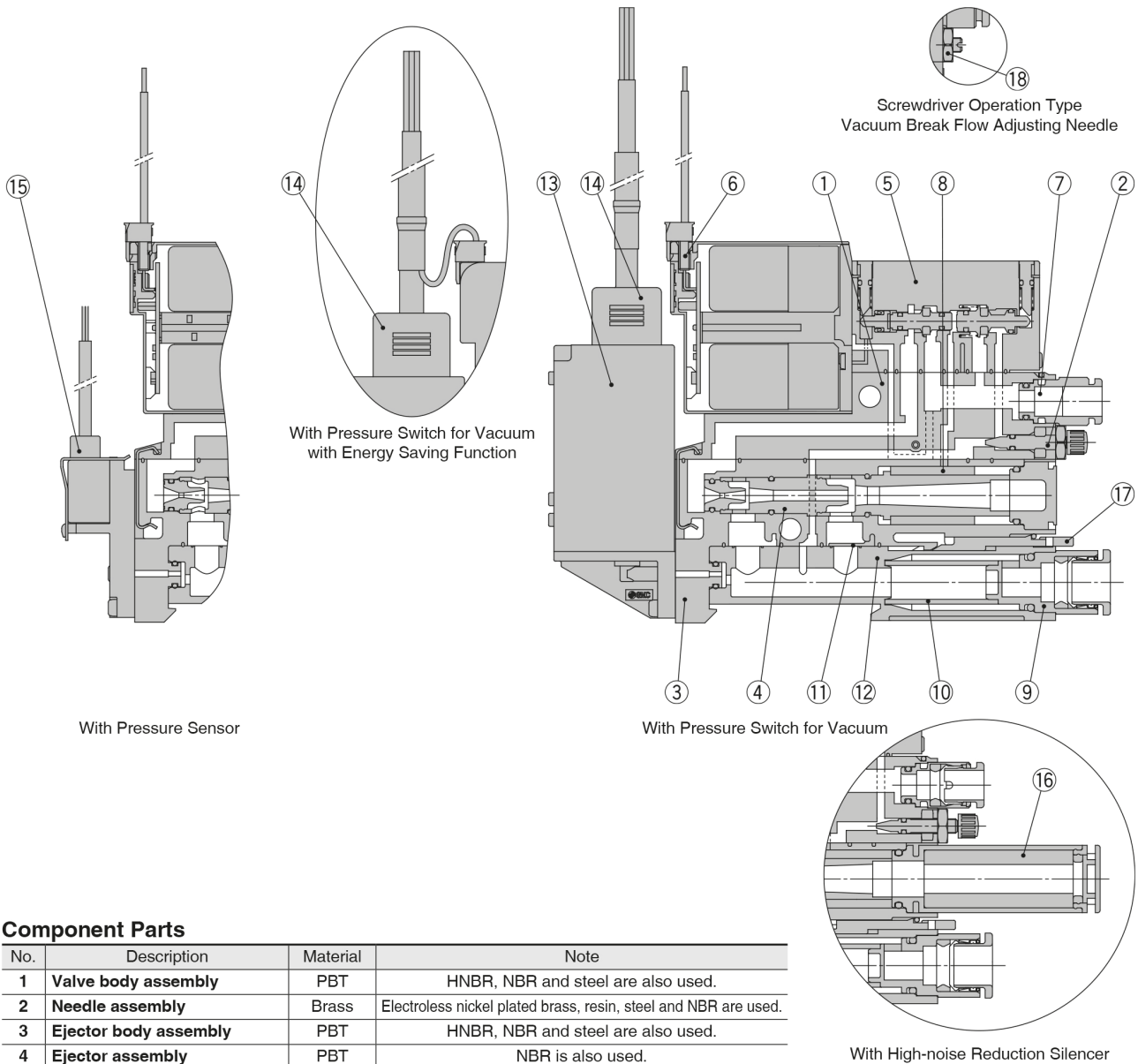

Component Parts

No.	Description	Material	Note
1	Valve body assembly	PBT	HNBR, NBR and steel are also used.
2	Needle assembly	Brass	Electroless nickel plated brass, resin, steel and NBR are used.
3	Ejector body assembly	PBT	HNBR, NBR and steel are also used.
4	Ejector assembly	PBT	NBR is also used.

Replacement Parts

No.	Description	Note
5	Valve assembly	—
6	Connector assembly	Connector for solenoid valve 3 wire (For valve type K/R), 2 wire (For valve type J)
7	One-touch fitting assembly	Metric size: $\varnothing 6$, Inch size: $\varnothing 1/4$ "
8	Sound absorbing material	10 pcs. per set
9	Vacuum port adapter assembly	With One-touch fitting and filter element
10	Filter element	Nominal filtration rating: 30 μm , 10 pcs. per set
11	Body gasket	Gasket integrated with the exhaust interference prevention valve, 10 pcs. per set
12	Filter case	Case body: Polycarbonate (Refer to the Specific Product Precautions on page 47.) Clear filter case: without a port for the pressure switch or sensor, Opaque filter case: with a port for the pressure switch or sensor
13	Vacuum pressure switch assembly	With 2 screws and 1 gasket
14	Lead wire with connector	—
15	Pressure sensor assembly	With 2 screws and 1 gasket
16	High-noise reduction silencer case assembly	With sound absorbing material (Part number: ZK2-SE4-6-A)
17	Release lever	10 pcs. per set
18	Lock nut	10 pcs. per set

Additional information

Catalogue	ZK2A-B_EU.pdf
Declaration of conformity	newDoC_ZK2-A_TF1Z208EN.pdf
Installation manuals	IM_ZK2-A_TF2Z368EN-A.pdf
Operation manuals	OM_ZK2-ZSV-A_OM00501EN-B.pdf OM_ZK2xA_OM01301EN.pdf