

CXSM, Dual Piston Rods, Slide Bearing

CXSM10-50

Datasheet

General series information

- Dual rod cylinder with slide bearing
- Bore sizes: 6, 10, 15, 20, 25, 32 (mm)
- Strokes from 10mm through 100mm depending upon bore size
- Variety of switches and a variety of lead wire lengths



Double-acting, single-rod cylinder

Standard specifications

Bore Size	10mm
Thread	ø6-ø20 Bore: M Thread; ø25,ø32 Bore: Rc 1/8
Lube-retainer	Without Stable Lubrication Function
Stroke	50mm
Auto Switch	No Switch
Lead Wire or Prewired Connector	0.5m [Or None in the Case of No Switch]
Number	2 pcs. [Or None in the Case of No Switch]
Pressure medium	Air (non-lube)
Maximum operating pressure	0.7 MPa
Minimum operating pressure	0.1 MPa
Proof pressure	1.05 MPa
Maximum ambient temperature	60 °C
Minimum ambient temperature	-10 °C
Type of cushioning	Rubber Bumper
Port size	M5
Piston speed	30 - 800 mm/s
Stroke adjustable range	0 to -5mm compared to the standard stroke
Weight	0.230 Kg

Dimensions

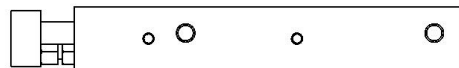
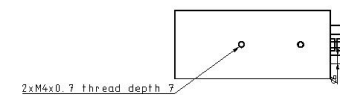
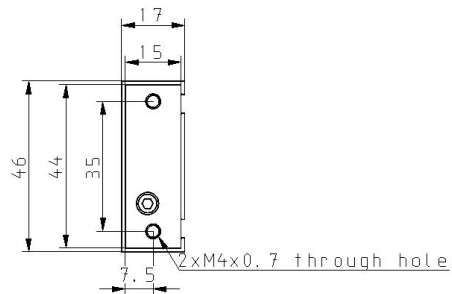
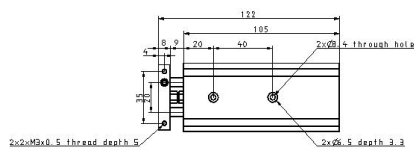
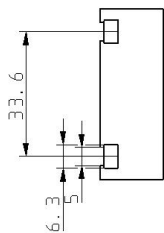
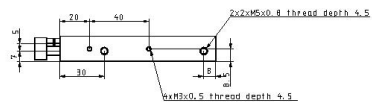

Constructions

CXSM10

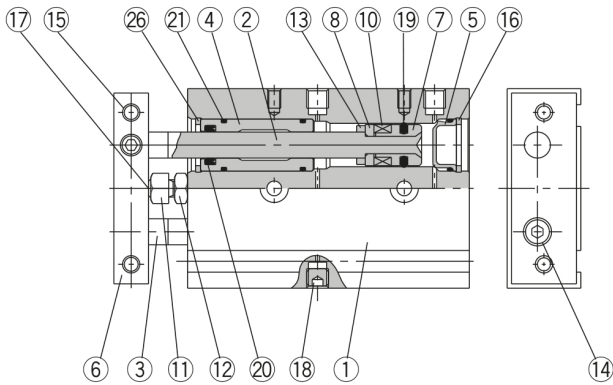

Parts list

No.	Description	Material	Note
1	Housing	Aluminum alloy	Hard anodized
2	Piston rod A	Carbon steel ^{Note 1)}	Hard chrome plated
3	Piston rod B	Carbon steel ^{Note 1)}	Hard chrome plated
4	Rod cover/Bearing	Aluminum alloy	
5	Head cover	Special steel ^{Note 2)}	
6	Plate	Aluminum alloy	Hard anodized
7	Piston A	Aluminum alloy	Chromated
8	Piston B	Aluminum alloy	Chromated
9	Bumper A	Polyurethane	
10	Magnet	Magnetic material	
11	Bumper bolt	Carbon steel	Nickel plated
12	Hexagon nut	Carbon steel	Nickel plated
13	Bumper B	Polyurethane	
14	Hexagon socket head cap screw	Chromium steel	Nickel plated
15	Hexagon socket head set screw	Chromium steel	Nickel plated
16	Snap ring	Special steel	Nickel plated



Note 1) Stainless steel for CXSM6.

Note 2) Anodized aluminum alloy for CXSM6.

Parts list

No.	Description	Material	Note
17	Bumper	Polyurethane	
18	Plug	Chromium steel	Nickel plated
19	Piston seal	NBR	
20	Rod seal	NBR	
21	O-ring	NBR	
22	Head cover B	Aluminum alloy	Nickel plated
23	Seal retainer	Aluminum alloy	
24	Port spacer	Aluminum alloy	
25	Steel ball	Special steel	Hard chrome plated
26	Snap ring B	Special steel	Nickel plated

Additional information

Catalogue

[CXS_EU.pdf](#)