

C(D)QS, Compact Cylinder, Double Acting, Single Rod CQSB12-30D

Datasheet

General series information

- Standard double acting single rod
- Bore sizes: 12, 16, 20, 25 (mm)
- Strokes from 5mm through 300mm depending upon bore size
- Mounts: through hole/both ends tapped, foot, front or rear flanges, double clevis
- Variety of switches and a variety of lead wire lengths



Double-acting, single-rod cylinder

Standard specifications

Magnet	None
Mounting	B (Through Hole, Both Ends Tapped)
Bore Size	Ø12 mm
Lube-retainer	Without Stable Lubrication Function
Stroke	30
Option	Standard (Rod End Female Thread)
Auto Switch	No Switch
Lead Wire or Prewired Connector	0.5 m (Or None in the Case of No Switch)
Number	2 pcs.
Rod End Options	None
Pressure medium	Air
Maximum temperature of pressure medium	70 °C
Minimum temperature of pressure medium	-10 °C
Maximum operating pressure	1.0 MPa
Minimum operating pressure	0.07 MPa
Proof pressure	1.5 MPa
Maximum ambient temperature	70 °C
Minimum ambient temperature	-10 °C

Number of pneumatic connections	2 pcs.
Pneumatic input connection	M5
Mode of operation of drive	Double acting
Theoretical cylinder force, advance stroke (at 0.5 MPa)	57 N
Theoretical cylinder force, return stroke (at 0.5 MPa)	42 N
Maximum piston speed	500 mm/s
Piston rod end	Internal thread
Geometric form of the piston rod	Round piston rod
Male thread of rod end	M5
Female thread of rod end	M3
Minimum piston speed	50 mm/s
Lubrication	Non-lube
Weight	0.070 Kg

Dimensions

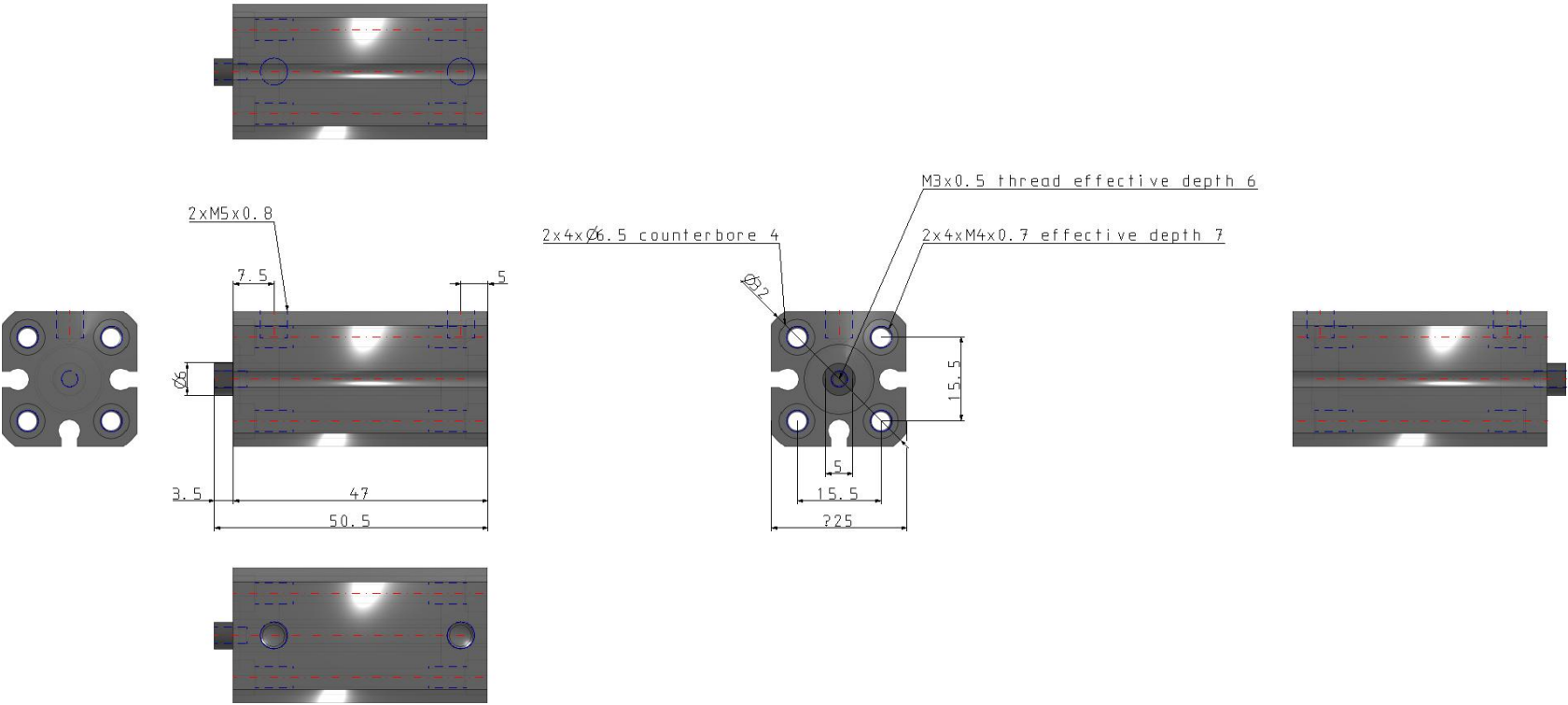

Constructions

Construction

Basic

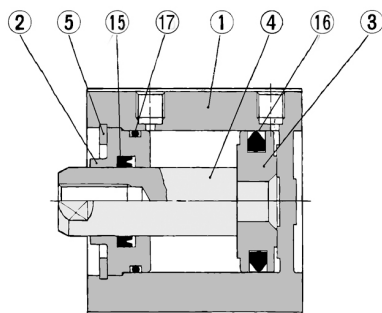

Component Parts

No.	Description	Material	Note
①	Cylinder tube	Aluminum alloy	Hard anodized
②	Collar	Aluminum bearing alloy	Anodized
③	Piston	Aluminum alloy	Chromated
④	Piston rod	Stainless steel	
⑤	Snap ring	Carbon tool steel	Phosphate coating
⑮	Rod seal	NBR	
⑯	Piston seal	NBR	
⑰	Tube gasket	NBR	

Additional information

Catalogue

[CQS_EU.pdf](#)