

New

Clean Wet Series

Fluoropolymer Piping Equipment

Fluoropolymer Fittings Hyper Fittings Series LQ1

New

675 new varieties
have also been added!



New PFA

Fluoropolymer Fittings Hyper Fittings / Flare Type Series LQ3



New PFA

Needle Valve Series LVN



New PFA

Bore Through Connector Series LQHB

New



New PFA

High Purity Fluoropolymer Tubing Series TL/TIL



Super PFA

Soft Fluoropolymer Tubing Series TD/TID



Modified PTFE

FEP Tubing (Fluoropolymer) Series TH/TIH



FEP



CAT.EUS70-39A-UK

Fluoropolymer Fittings Hyper Fittings

Quadruple sealing construction

The quadruple sealing construction (PAT.) based on SMC's original idea results in highly reliable sealing characteristics with outstanding leakage prevention effect.

Flow-through characteristics

Excellent flow-through characteristics are achieved by minimising liquid deposit.

200°C compatible

Locking

- Locking mechanism utilises sealing lock by the nut.
- Trapezoidal thread allows application of high torque.
- 2 stage pressing by the tubing holder of the nut ensures secure tube holding.



Basic

2 stage pressing construction ensures sealing and tubing locking to absorb differences in the tube outside diameter.

D side sealing

A seal is formed when the tubing is inserted, with its insert bushing, and its compression against the internal nut.

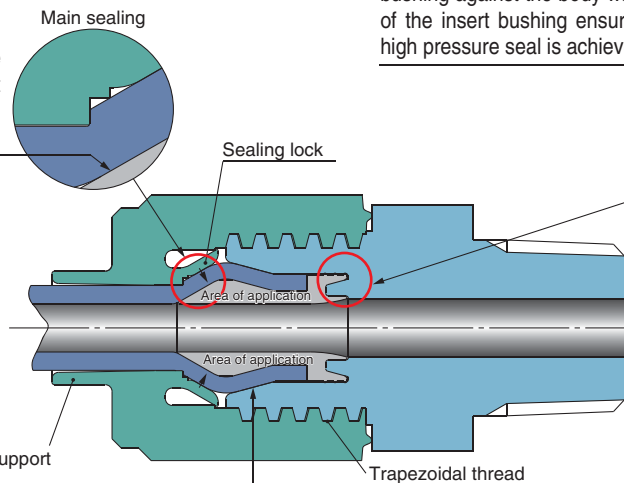

B side sealing

By tapering the face of the body, perfect sealing is achieved by the pressure of the bushing against the body wall (the protrusion of the insert bushing ensures that a secure high pressure seal is achieved).

A side sealing

The fluid pressure pushes the seal face to get effective sealing.

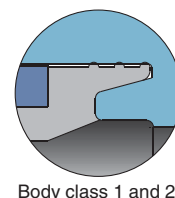
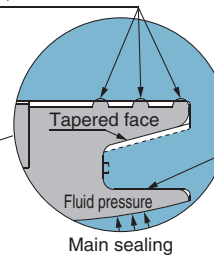

C side sealing

Sealed by the pressure exerted on the tubing by the internal nut.

Strong resistance to tube bending and deformation.

Able to withstand lateral loads with the tubing support.

Easy tightening of nuts.

- No positioning guide is required, simply tighten up the tubing to the end of the fitting body.
- The trapezoidal thread prevents oblique nut insertion.

Tubing sizes are interchangeable.

- The reducer method allows tubing size changes without replacing the body.
- Helps standardise fitting items resulting in less stock requirements.

Reducing type

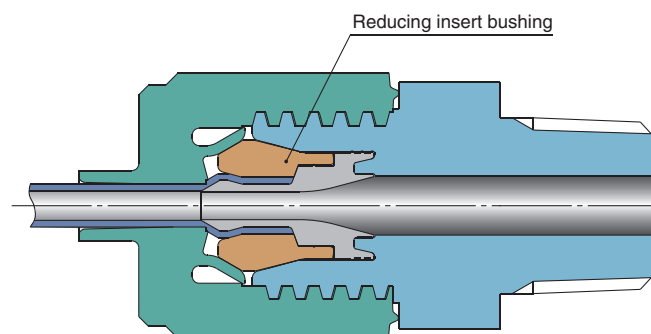

New

- The LQ1 Series consists of 488 product variation
A further **675** new varieties have also been added!
Making a full range of **1163** products!

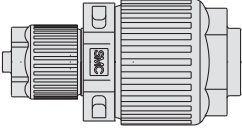
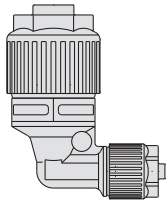
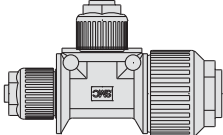
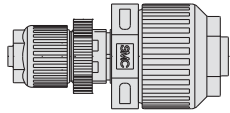
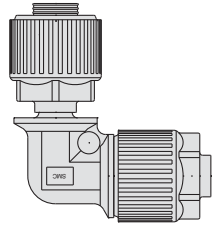
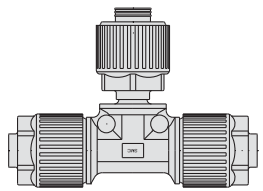
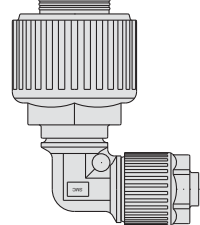
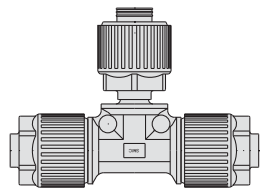
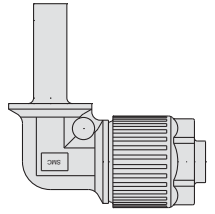
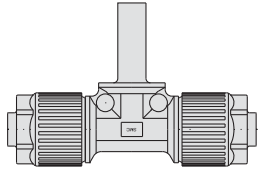
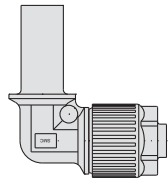
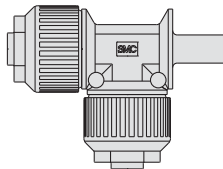

● Newly introduced shape

<p>Union reducing</p> 	<p>Union elbow reducing</p> 	<p>Union tee reducing</p> 	<p>Panel mount union reducing</p> 
<p>Space saving union elbow</p> 	<p>Space saving union tee</p> 	<p>Space saving union elbow reducing</p> 	<p>Space saving union tee reducing</p> 
<p>Tubing extension union elbow</p> 	<p>Tubing extension union tee</p> 	<p>Tubing extension union elbow reducing</p> 	<p>Tubing extension union tee reducing</p> 

● Space-saving, piping work-saving

- Cut down on the fittings use by a variation upgrade on the different diameter connection(s).

Cut down on longitudinal dimension

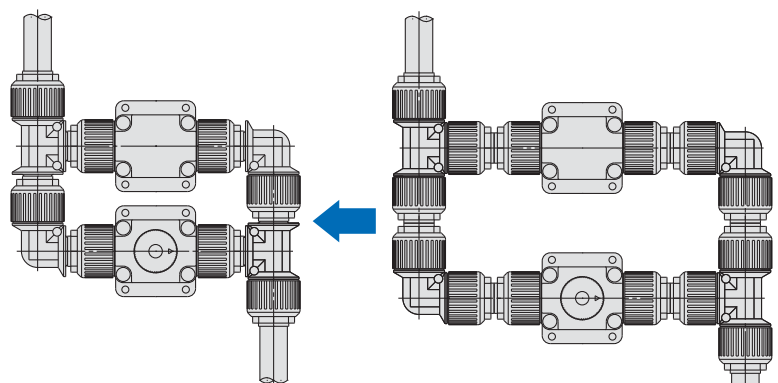

New Style

Conventional Style

- Flare type collet construction
- Triple-seal construction
- Ease of installation
- Excellent flow-through characteristics
- Excellent heat resistance
- **200°C compatible**



- Tubing retainer of the nut is made from a two-stage structure, enabling it to hold the tubing firmly.
- Fitting's seal surface to the tubing adopts a unique design to the area's pressure, resulting in improved sealing performance.

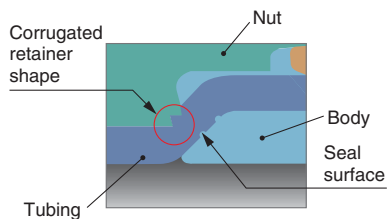

- To establish the tightening position, a gauge control is not required as the nut is designed to be tightened until the end surface of the fitting's main body.

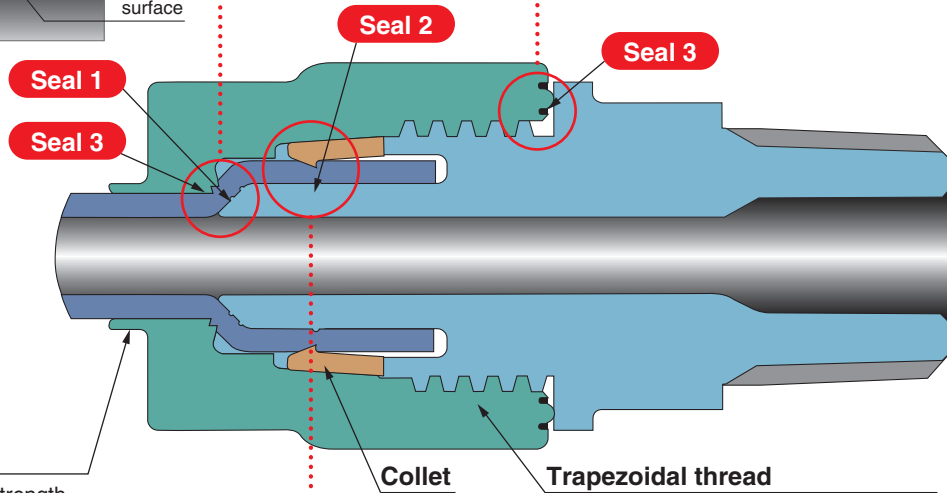
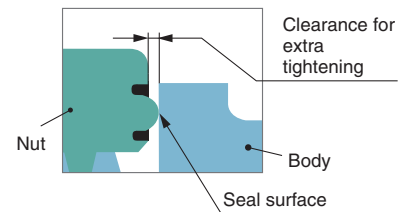

Tubing support

Providing additional strength against possible tube bending or deformation.

Trapezoidal thread

Prevents the nut from loosening at a high tightening torque, and from installing in a tilted position.
Heat resistant.

- Strengthening the prevention of the tubing release by means of the collet structure.
- Sealing performance is highly maintained in a circumferential seal surface having a unique shape even under thermal stress conditions.

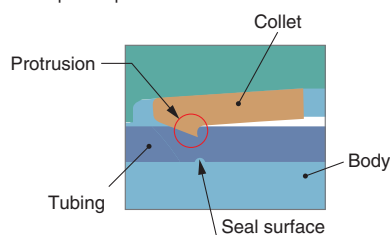

High Purity Fluoropolymer Needle Valve *Series LVN* P.65



Integral fitting construction

(Hyper fitting, Series LQ2 is used.)

- Quadruple sealing method
- Nut locking mechanism
- High flexural strength
- Different tubing sizes can be selected.

● Fluid adjustment range 0 to 12 L/min

● Integral fitting construction

Hyper fitting, Series LQ2 is used.

● Triple seal construction

Triple seal construction

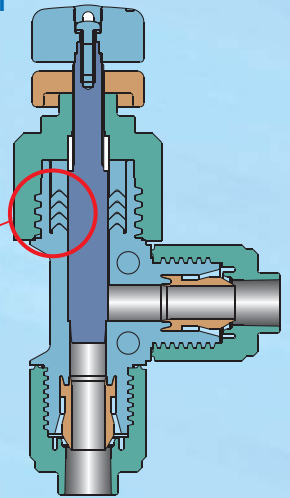

New

Fluoropolymer Bore Through Connector *Series LQHB* P.68

● Freely choose tube positioning

Can be used in pressure feed of chemicals, etc., during the production process of semiconductors. Applicable to chemicals such as acid, alkali and deionised water.

As the tube runs through the fitting itself, a setting is available for any optional position.



Easy tightening of nuts

The trapezoidal thread prevents oblique nut insertion.

Nut

Material: New PFA
Maximum operating temperature **200°C**

Taper thread

Thread type: R, NPT

Body

Material: New PFA

Locking

Trapezoidal thread allows application of high torque.

Collet

The tube is held securely in place by the tightening nut and collet. Material: PTFE

Applications

Pressure feed of chemicals

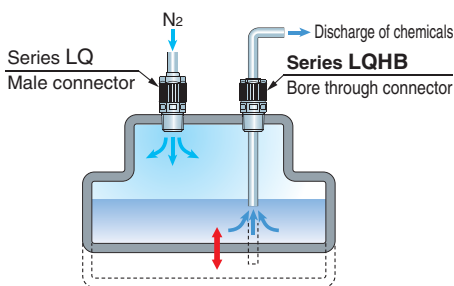

A changing of the tube position is available in accordance with the depth of the container.

Water trap

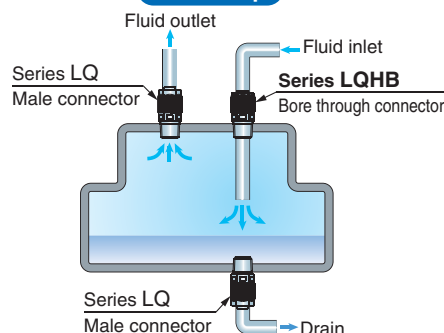

Fluid temperature control

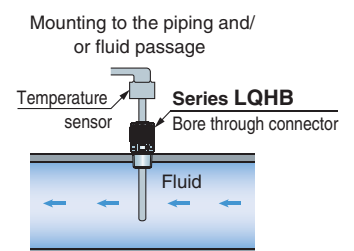

High Purity Fluoropolymer Tubing *Series TL/TIL* P.73

Operating Temperature ^{Note)} Max. 260°C

Note) It varies depending on the conditions.
For details, refer to page 73.

Materials: Super PFA

14 size Variations

- Metric Sizes: ø4 to ø19 (6 size)
- Inch Sizes: 1/8" to 1" (8 size)



Soft Fluoropolymer Tubing *Series TD/TID* P.74

Flexibility: Improved by approx. 20%

* SMC comparison (Fluoropolymer tubing, Series TL/TIL)

Applications: Food, Semi-conductor, Medical, Automobile and Machine tools fields

Compatible with the Food Sanitation Law

- Compatible with the test conforming to the Food Sanitation Law based on the 370th notice given by the Ministry of Health and Welfare in 1959.
- Compatible with the §177-1550 dissolution test approved by FDA (Food and Drug Administration).

Material: Modified PTFE

Operating Temperature ^{Note)} Max. 260°C

Note) It varies depending on the operating pressure.
Refer to the graph for maximum operating pressure (page 74, 75).

10 size variations

- Metric Sizes: ø4 to ø12 (5 size)
- Inch Sizes: 1/8" to 1/2" (ø3.18 to ø12.7) (5 size)



FEP Tubing (Fluoropolymer) *Series TH/THH* P.77

Operating Temperature ^{Note)} Max. 200°C

Note) It varies depending on the operating pressure. Refer to the graph for maximum operating pressure (pages 77 and 78).

Material: FEP

4 Color Variations: Translucent, Black, Red, Blue

19 size variations

- Metric Sizes: ø4 to ø12
- Inch Sizes: 1/8" to 3/4"

Applications: For general pneumatic piping Food, Semi-conductor, Medical and Automobile fields

Compatible with the Food Sanitation Law

Compatible with the test conforming to the Food Sanitation Law based on the 370th notice given by the Ministry of Health and Welfare in 1959.



Series LQ1

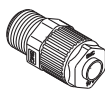
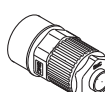
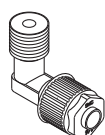
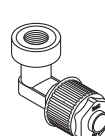
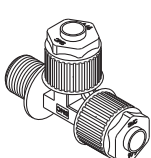
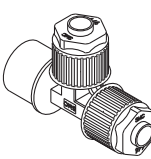

Fluoropolymer Fittings Hyper Fittings

Series LQ1 P.1

Series	Appearance	Class	Port size							Tubing O.D.																
										Metric size							Inch size									
			None	1/8"	1/4"	3/8"	1/2"	3/4"	1"	ø3	ø4	ø6	ø8	ø10	ø12	ø19	ø25	1/8"	3/16"	1/4"	3/8"	1/2"	3/4"	1"		
Connector LQ1H	Male	 P.4	1	-	○	-	-	-	-	○	○	-	-	-	-	-	-	○	-	-	-	-	-	-	-	
			2	-	○	○	-	-	-	-	●	●	○	-	-	-	-	-	●	●	○	-	-	-	-	-
			3	-	○	○	○	-	-	-	●	●	●	●	○	-	-	-	●	-	●	○	-	-	-	-
			4	-	-	○	○	○	-	-	●	-	●	●	●	○	-	-	●	-	●	●	○	-	-	-
			5	-	-	○	○	○	○	-	-	-	●	-	○	●	○	-	-	-	●	○	●	○	-	-
			6	-	-	-	-	○	○	○	-	-	-	-	-	●	●	○	-	-	-	-	●	●	○	-
	Female	 P.5	1	-	○	-	-	-	-	○	○	-	-	-	-	-	-	○	-	-	-	-	-	-	-	
			2	-	○	○	-	-	-	-	●	●	○	-	-	-	-	-	●	●	○	-	-	-	-	
			3	-	○	○	○	-	-	-	-	●	●	○	-	-	-	-	●	-	●	○	-	-	-	
			4	-	○	○	○	○	-	-	-	●	●	●	○	-	-	-	-	○	●	○	-	-	-	
			5	-	-	○	○	○	○	-	-	-	-	-	-	●	○	-	-	-	-	●	○	-	-	
			6	-	-	-	-	-	○	○	-	-	-	-	-	-	●	○	-	-	-	-	-	●	○	
Elbow LQ1L	Male	 P.6	1	-	○	-	-	-	-	○	○	-	-	-	-	-	-	○	-	-	-	-	-	-		
			2	-	○	○	-	-	-	-	●	●	○	-	-	-	-	-	●	●	○	-	-	-	-	
			3	-	○	○	○	-	-	-	●	●	●	●	○	-	-	-	●	-	●	○	-	-	-	
			4	-	-	○	○	○	-	-	●	●	●	●	○	-	-	-	●	-	●	●	○	-	-	
			5	-	-	-	○	○	○	-	-	-	●	●	○	●	○	-	-	-	●	○	●	○	-	
			6	-	-	-	○	-	○	○	-	-	-	-	-	●	●	○	-	-	-	-	●	●	○	
	Female	 P.7	1	-	○	-	-	-	-	○	○	-	-	-	-	-	-	○	-	-	-	-	-	-		
			2	-	○	○	-	-	-	-	●	●	○	-	-	-	-	-	●	●	○	-	-	-	-	
			3	-	○	○	○	-	-	-	●	-	●	●	○	-	-	-	●	-	●	○	-	-	-	
			4	-	○	○	○	○	-	-	-	-	-	●	○	-	-	-	-	-	●	○	-	-	-	
			5	-	-	-	○	○	○	-	-	-	-	-	-	●	○	-	-	-	-	●	○	-	-	
			6	-	-	-	-	-	○	○	-	-	-	-	-	-	●	○	-	-	-	-	-	●	○	
Run tee LQ1R	Male	 P.8	1	-	○	-	-	-	-	○	○	-	-	-	-	-	-	○	-	-	-	-	-	-		
			2	-	○	○	-	-	-	-	●	●	○	-	-	-	-	-	●	●	○	-	-	-	-	
			3	-	○	○	○	-	-	-	-	●	●	○	-	-	-	-	-	●	○	-	-	-	-	
			4	-	-	○	○	○	-	-	-	-	-	●	○	-	-	-	-	-	●	○	-	-	-	
			5	-	-	○	○	○	○	-	-	-	-	-	-	●	○	-	-	-	-	●	○	-	-	
			6	-	-	-	-	-	○	○	-	-	-	-	-	-	●	○	-	-	-	-	-	●	○	
	Female	 P.9	1	-	○	-	-	-	-	○	○	-	-	-	-	-	-	○	-	-	-	-	-	-		
			2	-	○	○	-	-	-	-	●	●	○	-	-	-	-	-	●	●	○	-	-	-	-	
			3	-	○	○	○	-	-	-	-	●	●	○	-	-	-	-	-	●	○	-	-	-	-	
			4	-	-	○	○	○	-	-	-	-	-	●	○	-	-	-	-	-	●	○	-	-	-	
			5	-	-	-	○	○	○	-	-	-	-	-	-	●	○	-	-	-	-	●	○	-	-	
			6	-	-	-	-	-	○	○	-	-	-	-	-	-	●	○	-	-	-	-	-	●	○	

Note) ○Basic size ●With reducer

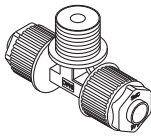
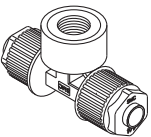
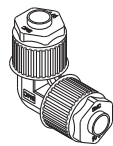
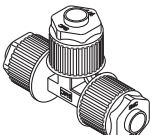
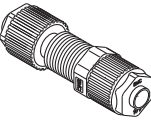
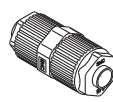
Series LQ1

Series	Appearance	Class	Port size							Tubing O.D.														
										Metric size							Inch size							
			None	1/8"	1/4"	3/8"	1/2"	3/4"	1"	ø3	ø4	ø6	ø8	ø10	ø12	ø19	ø25	1/8"	3/16"	1/4"	3/8"	1/2"	3/4"	1"
Branch tee LQ1B	Male  P.10	1	-	○	-	-	-	-	-	○	○	-	-	-	-	-	-	○	-	-	-	-	-	-
		2	-	○	○	-	-	-	-	●	●	○	-	-	-	-	-	●	●	○	-	-	-	-
		3	-	○	○	○	-	-	-	-	●	●	○	-	-	-	-	-	●	○	-	-	-	-
		4	-	-	○	○	○	-	-	-	-	●	●	○	-	-	-	-	-	●	○	-	-	-
		5	-	-	○	○	○	○	-	-	-	-	-	●	○	-	-	-	-	-	●	○	-	-
		6	-	-	-	-	○	○	○	-	-	-	-	-	-	●	○	-	-	-	-	●	○	-
	Female  P.11	1	-	○	-	-	-	-	-	○	○	-	-	-	-	-	-	○	-	-	-	-	-	-
		2	-	○	○	-	-	-	-	●	●	○	-	-	-	-	-	●	●	○	-	-	-	-
		3	-	○	○	○	-	-	-	-	●	●	○	-	-	-	-	-	●	○	-	-	-	-
		4	-	-	○	○	○	-	-	-	-	-	●	○	-	-	-	-	-	●	○	-	-	-
		5	-	-	○	○	○	○	-	-	-	-	-	●	○	-	-	-	-	-	●	○	-	-
		6	-	-	-	-	○	○	○	-	-	-	-	-	-	●	○	-	-	-	-	●	○	-
Union elbow LQ1E	 P.12	1	○	-	-	-	-	-	-	○	○	-	-	-	-	-	-	○	-	-	-	-	-	
		2	○	-	-	-	-	-	-	●	●	○	-	-	-	-	-	●	●	○	-	-	-	-
		3	○	-	-	-	-	-	-	-	●	●	○	-	-	-	-	-	●	○	-	-	-	-
		4	○	-	-	-	-	-	-	-	-	-	●	○	-	-	-	-	-	●	○	-	-	-
		5	○	-	-	-	-	-	-	-	-	-	-	●	○	-	-	-	-	-	●	○	-	-
		6	○	-	-	-	-	-	-	-	-	-	-	-	●	○	-	-	-	-	-	●	○	-
Union tee LQ1T	 P.13	1	○	-	-	-	-	-	-	○	○	-	-	-	-	-	-	○	-	-	-	-	-	
		2	○	-	-	-	-	-	-	●	●	○	-	-	-	-	-	●	●	○	-	-	-	-
		3	○	-	-	-	-	-	-	-	●	●	○	-	-	-	-	-	●	○	-	-	-	-
		4	○	-	-	-	-	-	-	-	-	-	●	○	-	-	-	-	-	●	○	-	-	-
		5	○	-	-	-	-	-	-	-	-	-	-	●	○	-	-	-	-	-	●	○	-	-
		6	○	-	-	-	-	-	-	-	-	-	-	-	●	○	-	-	-	-	-	●	○	-
Panel mount union LQ1P	 P.14	1	○	-	-	-	-	-	-	○	○	-	-	-	-	-	-	○	-	-	-	-	-	
		2	○	-	-	-	-	-	-	●	●	○	-	-	-	-	-	●	●	○	-	-	-	-
		3	○	-	-	-	-	-	-	-	●	●	○	-	-	-	-	-	●	○	-	-	-	-
		4	○	-	-	-	-	-	-	-	-	-	●	○	-	-	-	-	-	●	○	-	-	-
		5	○	-	-	-	-	-	-	-	-	-	-	●	○	-	-	-	-	-	●	○	-	-
		6	○	-	-	-	-	-	-	-	-	-	-	-	●	○	-	-	-	-	-	●	○	-
Union LQ1U	 P.15	1	○	-	-	-	-	-	-	○	○	-	-	-	-	-	-	○	-	-	-	-	-	
		2	○	-	-	-	-	-	-	●	●	○	-	-	-	-	-	●	●	○	-	-	-	-
		3	○	-	-	-	-	-	-	-	●	●	○	-	-	-	-	-	●	○	-	-	-	-
		4	○	-	-	-	-	-	-	-	-	-	●	○	-	-	-	-	-	●	○	-	-	-
		5	○	-	-	-	-	-	-	-	-	-	-	●	○	-	-	-	-	-	●	○	-	-
		6	○	-	-	-	-	-	-	-	-	-	-	-	●	○	-	-	-	-	-	●	○	-
Union flange LQ1F	 P.15	4	○	-	-	-	-	-	-	-	-	●	○	-	-	-	-	-	●	○	-	-	-	
		5	○	-	-	-	-	-	-	-	-	-	-	●	○	-	-	-	-	-	●	○	-	-
		6	○	-	-	-	-	-	-	-	-	-	-	-	●	○	-	-	-	-	-	●	○	-

Note) ○Basic size ●With reducer

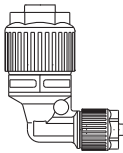
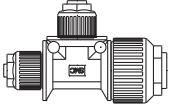
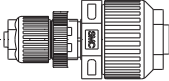
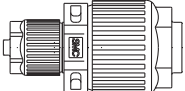
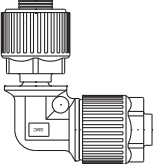
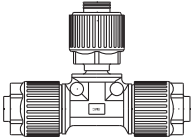

Series	Appearance	Class	Tubing O.D.																	
			Metric size							Inch size										
			ø3	ø4	ø6	ø8	ø10	ø12	ø19	ø25	1/8"	3/16"	1/4"	3/8"	1/2"	3/4"	1"			
Union elbow reducing LQ1E-R		P.16	2	●	●	○	-	-	-	-	-	●	●	○	-	-	-	-		
			3	-	-	●	●	○	-	-	-	-	-	●	○	-	-	-	-	
			4	●	-	●	●	●	○	-	-	●	●	●	●	○	-	-	-	
			5	-	●	●	●	●	●	○	-	-	●	●	●	●	○	-	-	-
			6	-	-	●	●	●	●	●	○	-	●	●	●	●	●	○	-	-
			Union tee reducing LQ1T-R		P.18	2	●	●	○	-	-	-	-	-	●	●	○	-	-	-
3	●	-				●	●	○	-	-	-	-	-	●	○	-	-	-	-	
4	●	-				●	●	●	○	-	-	●	-	●	●	○	-	-	-	-
5	●	●				●	●	●	●	○	-	●	-	●	●	●	○	-	-	-
6	-	-				●	●	●	●	●	○	-	-	●	●	●	●	○	-	-
Panel mount union reducing LQ1P-R		P.23				2	●	●	○	-	-	-	-	-	●	●	○	-	-	-
			3	-	-	●	●	○	-	-	-	-	-	●	○	-	-	-	-	
			4	-	-	●	-	●	○	-	-	-	-	●	●	○	-	-	-	-
			5	-	-	-	-	●	●	○	-	-	-	-	●	●	○	-	-	-
			6	-	-	-	-	-	-	●	○	-	-	-	-	-	-	●	○	-
			Union reducing LQ1U-R		P.24	2	●	●	○	-	-	-	-	-	●	●	○	-	-	-
3	●	●				●	●	○	-	-	-	●	●	●	○	-	-	-	-	
4	●	●				●	●	●	○	-	-	●	●	●	●	○	-	-	-	-
5	●	●				●	●	●	●	○	-	●	●	●	●	●	○	-	-	-
6	-	-				●	-	●	●	●	○	-	-	●	●	●	●	○	-	-
Space saving union elbow LQ1E-SS		P.25				2	-	-	○	-	-	-	-	-	-	-	○	-	-	-
			3	-	-	-	●	○	-	-	-	-	-	-	○	-	-	-	-	
			4	-	-	-	-	-	○	-	-	-	-	-	-	○	-	-	-	-
			5	-	-	-	-	-	-	○	-	-	-	-	-	-	-	○	-	-
			6	-	-	-	-	-	-	-	○	-	-	-	-	-	-	-	-	○
			Space saving union tee LQ1T-S		P.27	2	-	-	○	-	-	-	-	-	-	-	○	-	-	-
3	-	-				-	●	○	-	-	-	-	-	-	○	-	-	-	-	
4	-	-				-	-	-	○	-	-	-	-	-	-	○	-	-	-	-
5	-	-				-	-	-	-	○	-	-	-	-	-	-	-	○	-	-
6	-	-				-	-	-	-	-	○	-	-	-	-	-	-	-	-	○

Note) ○Basic size ●With reducer

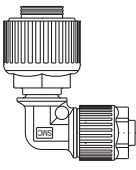
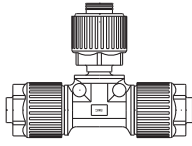
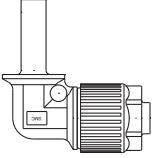
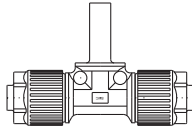
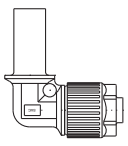
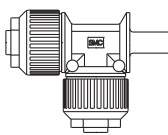
Series LQ1

Series	Appearance	Class	Tubing O.D.														Can be connected body class									
			Metric size							Inch size																
			ø3	ø4	ø6	ø8	ø10	ø12	ø19	ø25	1/8"	3/16"	1/4"	3/8"	1/2"	3/4"	1"	2	3	4	5	6				
Space saving union elbow reducing LQ1E-SS-R		P.26	2	-	-	○	-	-	-	-	-	-	-	○	-	-	-	-	-	○	○	-	-			
			3	-	-	-	○	○	-	-	-	-	-	○	-	-	-	-	-	○	○	○	-	-		
			4	-	-	-	-	-	○	-	-	-	-	-	○	-	-	-	-	-	○	○	-	○	-	
			5	-	-	-	-	-	-	-	-	-	-	-	-	-	-	-	-	-	-	-	-	-	-	
			6	-	-	-	-	-	-	-	○	-	-	-	-	-	-	-	-	-	○	-	-	-	○	-
			Space saving union tee reducing LQ1T-S-R		P.28	2	-	-	○	-	-	-	-	-	-	-	-	-	-	-	-	-	○	-	-	-
3	-	-				-	●	-	-	-	-	-	-	●	○	-	-	-	-	-	○	-	-	-		
4	-	-				-	-	-	○	-	-	-	-	-	●	○	-	-	-	-	-	○	-	○	-	
5	-	-				○	-	-	●	○	-	-	-	-	●	-	●	○	-	-	-	○	○	○	○	
6	-	-				-	-	-	-	●	○	-	-	-	-	-	-	●	○	-	-	○	○	○	○	
Tubing extension union elbow LQ1E-T		P.30				2	-	-	○	-	-	-	-	-	-	-	○	-	-	-	-	-	-	-	-	-
			3	-	-	-	●	○	-	-	-	-	-	-	-	○	-	-	-	-	-	-	-	-		
			4	-	-	-	-	-	○	-	-	-	-	-	-	○	-	-	-	-	-	-	-	-	-	
			5	-	-	-	-	-	-	○	-	-	-	-	-	-	○	-	-	-	-	-	-	-	-	
			6	-	-	-	-	-	-	-	○	-	-	-	-	-	-	○	-	-	-	-	-	-	-	
			Tubing extension union tee LQ1T-T		P.31	2	-	-	○	-	-	-	-	-	-	-	○	-	-	-	-	-	-	-	-	-
3	-	-				-	●	○	-	-	-	-	-	-	-	○	-	-	-	-	-	-	-	-		
4	-	-				-	-	-	○	-	-	-	-	-	-	-	○	-	-	-	-	-	-	-	-	
5	-	-				-	-	-	-	○	-	-	-	-	-	-	-	○	-	-	-	-	-	-	-	
6	-	-				-	-	-	-	-	○	-	-	-	-	-	-	-	○	-	-	-	-	-	-	
Tubing extension union elbow reducing LQ1E-T-R		P.32				2	-	-	○	○	○	○	-	-	-	-	○	○	-	-	-	-	-	○	○	-
			3	-	-	○	○	○	○	○	-	-	-	-	-	○	○	-	-	-	-	○	○	-	-	
			4	-	-	○	○	○	○	○	-	-	-	-	○	-	○	○	-	-	-	○	○	-	○	
			5	-	-	-	-	-	-	○	-	-	-	-	-	-	-	○	-	-	-	-	-	-	-	
			6	-	-	-	-	-	-	-	○	-	-	-	-	-	-	-	○	-	-	-	-	-	○	
			Tubing extension union tee reducing LQ1T-T-R		P.33	2	-	-	-	-	-	-	-	-	-	-	○	-	-	-	-	-	-	○	-	-
3	-	-				-	-	-	-	-	-	-	-	-	-	-	○	-	-	-	-	-	-	-		
4	-	-				-	-	-	○	-	-	-	-	-	-	●	○	-	-	-	-	-	○	-	-	
5	-	-				-	-	-	-	○	-	-	-	-	-	-	○	○	-	-	-	-	○	○	-	
6	-	-				-	-	-	-	-	○	-	-	-	-	-	-	○	○	-	-	-	-	○	○	

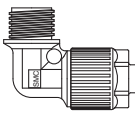
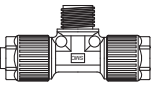
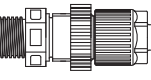
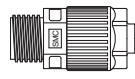

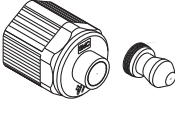
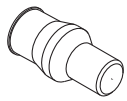
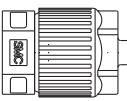







Note) ○Basic size ●With reducer

Series	Appearance	Class	Tubing O.D.														
			Metric size								Inch size						
			ø3	ø4	ø6	ø8	ø10	ø12	ø19	ø25	1/8"	3/16"	1/4"	3/8"	1/2"	3/4"	1"
Space saving union elbow LQ1E-S	 P.35	1	○	○	-	-	-	-	-	-	○	-	-	-	-	-	
		2	-	●	○	-	-	-	-	-	●	●	○	-	-	-	
		3	-	-	●	●	○	-	-	-	-	-	●	○	-	-	
		4	-	-	-	-	●	○	-	-	-	-	-	●	○	-	
		5	-	-	-	-	-	●	○	-	-	-	-	-	●	○	-
		6	-	-	-	-	-	-	●	○	-	-	-	-	-	●	○
Space saving union tee LQ1T-S	 P.35	1	○	○	-	-	-	-	-	-	○	-	-	-	-	-	
		2	-	●	○	-	-	-	-	-	●	●	○	-	-	-	
		3	-	-	●	●	○	-	-	-	-	-	●	○	-	-	
		4	-	-	-	-	●	○	-	-	-	-	-	●	○	-	
		5	-	-	-	-	-	●	○	-	-	-	-	-	●	○	-
		6	-	-	-	-	-	-	●	○	-	-	-	-	-	●	○
Space saving panel mount union LQ1P-S	 P.35	1	○	○	-	-	-	-	-	-	○	-	-	-	-	-	
		2	-	●	○	-	-	-	-	-	●	●	○	-	-	-	
		3	-	-	●	●	○	-	-	-	-	-	●	○	-	-	
		4	-	-	-	-	●	○	-	-	-	-	-	●	○	-	
		5	-	-	-	-	-	●	○	-	-	-	-	-	●	○	-
		6	-	-	-	-	-	-	●	○	-	-	-	-	-	●	○
Space saving union LQ1U-S	 P.35	1	○	○	-	-	-	-	-	-	○	-	-	-	-	-	
		2	-	●	○	-	-	-	-	-	●	●	○	-	-	-	
		3	-	-	●	●	○	-	-	-	-	-	●	○	-	-	
		4	-	-	-	-	●	○	-	-	-	-	-	●	○	-	
		5	-	-	-	-	-	●	○	-	-	-	-	-	●	○	-
		6	-	-	-	-	-	-	●	○	-	-	-	-	-	●	○
Panel mounting nut LQNP	 P.35	1	-	-	-	-	-	-	-	-	-	-	-	-	-	-	
		2	-	-	-	-	-	-	-	-	-	-	-	-	-	-	
		3	-	-	-	-	-	-	-	-	-	-	-	-	-	-	
		4	-	-	-	-	-	-	-	-	-	-	-	-	-	-	
		5	-	-	-	-	-	-	-	-	-	-	-	-	-	-	
		6	-	-	-	-	-	-	-	-	-	-	-	-	-	-	
Nut insert bush LQ1-U B N	 P.36	1	○	○	-	-	-	-	-	-	○	-	-	-	-	-	
		2	○	○	○	-	-	-	-	-	○	○	○	-	-	-	
		3	-	-	○	○	○	-	-	-	-	-	○	○	-	-	
		4	-	-	-	-	○	○	-	-	-	-	-	○	○	-	
		5	-	-	-	-	-	○	○	-	-	-	-	-	○	○	-
		6	-	-	-	-	-	-	○	○	-	-	-	-	-	○	○
Blanking plug LQ-P	 P.36	1	○	○	-	-	-	-	-	-	○	-	-	-	-	-	
		2	●	●	○	-	-	-	-	-	●	●	○	-	-	-	
		3	-	●	●	●	○	-	-	-	-	-	●	○	-	-	
		4	-	-	-	-	●	○	-	-	-	-	-	●	○	-	
		5	-	-	-	-	-	●	○	-	-	-	-	-	●	○	-
		6	-	-	-	-	-	-	●	○	-	-	-	-	-	●	○
Tubing plug LQ1-CP	 P.36	1	○	○	-	-	-	-	-	-	○	-	-	-	-	-	
		2	-	-	○	-	-	-	-	-	-	-	○	-	-	-	
		3	-	-	-	○	○	-	-	-	-	-	-	○	-	-	
		4	-	-	-	-	-	○	-	-	-	-	-	-	○	-	
		5	-	-	-	-	-	-	○	-	-	-	-	-	-	○	-
		6	-	-	-	-	-	-	-	○	-	-	-	-	-	-	○



Note) ○Basic size ●With reducer

Series LQ3

Series LQ3 P.39

Series	Appearance	Class	Port size								Tubing O.D.																
											Metric size							Inch size									
			None	1/8"	1/4"	3/8"	1/2"	3/4"	1"	1 1/4"	ø3	ø4	ø6	ø8	ø10	ø12	ø19	ø25	1/8"	1/4"	3/8"	1/2"	3/4"	1"	1 1/4"		
Connector LQ3H	Male	 P.42	1	-	●	-	-	-	-	-	-	●	●	-	-	-	-	-	●	-	-	-	-	-	-	-	
			2	-	●	●	-	-	-	-	-	-	-	-	●	-	-	-	-	-	●	-	-	-	-	-	-
			3	-	●	●	●	●	-	-	-	-	-	-	●	●	-	-	-	-	-	●	-	-	-	-	-
			4	-	-	●	●	●	●	-	-	-	-	-	-	●	-	-	-	-	-	-	●	-	-	-	-
			5	-	-	-	●	●	●	-	-	-	-	-	-	-	●	-	-	-	-	-	-	●	-	-	-
			6	-	-	-	-	●	●	●	-	-	-	-	-	-	-	●	-	-	-	-	-	-	●	-	-
	Female	 P.43	1	-	●	-	-	-	-	-	-	●	●	-	-	-	-	-	●	-	-	-	-	-	-	-	
			2	-	●	●	-	-	-	-	-	-	-	●	-	-	-	-	-	-	●	-	-	-	-	-	
			3	-	●	●	●	-	-	-	-	-	-	-	●	●	-	-	-	-	-	●	-	-	-	-	
			4	-	-	●	●	●	-	-	-	-	-	-	-	●	-	-	-	-	-	-	●	-	-	-	
			5	-	-	-	●	●	●	-	-	-	-	-	-	-	●	-	-	-	-	-	-	●	-	-	
			6	-	-	-	-	●	●	●	-	-	-	-	-	-	-	●	-	-	-	-	-	-	●	-	
Elbow LQ3L	Male	 P.44	1	-	●	-	-	-	-	-	-	●	●	-	-	-	-	-	●	-	-	-	-	-	-		
			2	-	●	●	-	-	-	-	-	-	-	●	-	-	-	-	-	-	-	●	-	-	-	-	
			3	-	●	●	●	●	-	-	-	-	-	-	●	●	-	-	-	-	-	●	-	-	-	-	
			4	-	-	●	●	●	-	-	-	-	-	-	-	●	-	-	-	-	-	-	●	-	-	-	
			5	-	-	-	●	●	●	-	-	-	-	-	-	-	●	-	-	-	-	-	-	●	-	-	
			6	-	-	-	-	●	●	●	-	-	-	-	-	-	-	●	-	-	-	-	-	-	●	-	
	Female	 P.45	1	-	●	-	-	-	-	-	-	●	●	-	-	-	-	-	●	-	-	-	-	-	-		
			2	-	●	●	-	-	-	-	-	-	-	●	-	-	-	-	-	-	-	●	-	-	-		
			3	-	●	●	●	-	-	-	-	-	-	-	●	●	-	-	-	-	-	●	-	-	-		
			4	-	-	●	●	●	-	-	-	-	-	-	-	●	-	-	-	-	-	-	●	-	-		
			5	-	-	-	●	●	●	-	-	-	-	-	-	-	●	-	-	-	-	-	-	●	-		
			6	-	-	-	-	●	●	●	-	-	-	-	-	-	-	●	-	-	-	-	-	-	●		
Branch tee LQ3B	Male	 P.46	1	-	●	-	-	-	-	-	-	●	●	-	-	-	-	-	●	-	-	-	-	-	-		
			2	-	●	●	-	-	-	-	-	-	-	●	-	-	-	-	-	-	-	●	-	-	-		
			3	-	●	●	●	-	-	-	-	-	-	-	●	●	-	-	-	-	-	●	-	-	-		
			4	-	-	●	●	●	-	-	-	-	-	-	-	●	-	-	-	-	-	-	●	-	-		
			5	-	-	-	●	●	●	-	-	-	-	-	-	-	●	-	-	-	-	-	-	●	-		
			6	-	-	-	-	●	●	●	-	-	-	-	-	-	-	●	-	-	-	-	-	●	-		
	Female	 P.47	1	-	●	-	-	-	-	-	-	●	●	-	-	-	-	-	●	-	-	-	-	-	-		
			2	-	●	●	-	-	-	-	-	-	-	●	-	-	-	-	-	-	-	●	-	-	-		
			3	-	●	●	●	-	-	-	-	-	-	-	●	●	-	-	-	-	-	●	-	-	-		
			4	-	-	●	●	●	-	-	-	-	-	-	-	●	-	-	-	-	-	-	●	-	-		
			5	-	-	-	●	●	●	-	-	-	-	-	-	-	●	-	-	-	-	-	-	●	-		
			6	-	-	-	-	●	●	●	-	-	-	-	-	-	-	●	-	-	-	-	-	-	●		
Run tee LQ3R	Male	 P.48	1	-	●	-	-	-	-	-	-	●	●	-	-	-	-	-	●	-	-	-	-	-	-		
			2	-	●	●	-	-	-	-	-	-	-	●	-	-	-	-	-	-	-	●	-	-	-		
			3	-	●	●	●	-	-	-	-	-	-	-	●	●	-	-	-	-	-	●	-	-	-		
			4	-	-	●	●	●	-	-	-	-	-	-	-	●	-	-	-	-	-	-	●	-	-		
			5	-	-	-	●	●	●	-	-	-	-	-	-	-	●	-	-	-	-	-	-	●	-		
			6	-	-	-	-	●	●	●	-	-	-	-	-	-	-	●	-	-	-	-	-	-	●		
	Female	 P.49	1	-	●	-	-	-	-	-	-	●	●	-	-	-	-	-	●	-	-	-	-	-	-		
			2	-	●	●	-	-	-	-	-	-	-	●	-	-	-	-	-	-	-	●	-	-	-		
			3	-	●	●	●	-	-	-	-	-	-	-	●	●	-	-	-	-	-	●	-	-	-		
			4	-	-	●	●	●	-	-	-	-	-	-	-	●	-	-	-	-	-	-	●	-	-		
			5	-	-	-	●	●	●	-	-	-	-	-	-	-	●	-	-	-	-	-	-	●	-		
			6	-	-	-	-	●	●	●	-	-	-	-	-	-	-	●	-	-	-	-	-	-	●		
Union elbow LQ3E	 P.50	1	●	-	-	-	-	-	-	-	●	●	-	-	-	-	-	●	-	-	-	-	-	-			
		2	●	-	-	-	-	-	-	-	-	-	●	-	-	-	-	-	-	●	-	-	-	-			
		3	●	-	-	-	-	-	-	-	-	-	-	●	●	-	-	-	-	-	●	-	-	-			
		4	●	-	-	-	-	-	-	-	-	-	-	-	-	●	-	-	-	-	-	●	-	-			
		5	●	-	-	-	-	-	-	-	-	-	-	-	-	-	●	-	-	-	-	-	●	-			
		6	●	-	-	-	-	-	-	-	-	-	-	-	-	-	-	●	-	-	-	-	-	●			
		7	-	-	-	-	-	-	-	-	-	-	-	-	-	-	-	-	-	-	-	-	-	-			
Union tee LQ3T	 P.50	1	●	-	-	-	-	-	-	-	●	●	-	-	-	-	-	●	-	-	-	-	-	-			
		2	●	-	-	-	-	-	-	-	-	-	●	-	-	-	-	-	-	●	-	-	-	-			
		3	●	-	-	-	-	-	-	-	-	-	-	●	●	-	-	-	-	-	●	-	-	-			
		4	●	-	-	-	-	-	-	-	-	-	-	-	-	●	-	-	-	-	-	●	-	-			
		5	●	-	-	-	-	-	-	-	-	-	-	-	-	-	●	-	-	-	-	-	●	-			
		6	●	-	-	-	-	-	-	-	-	-	-	-	-	-	-	●	-	-	-	-	-	●			

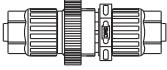
Fluoropolymer Fittings Hyper Fittings / Flare Type

Series	Appearance	Class	Port size								Tubing O.D.															
											Metric size							Inch size								
			None	1/8"	1/4"	3/8"	1/2"	3/4"	1"	1 1/4"	ø3	ø4	ø6	ø8	ø10	ø12	ø19	ø25	1/8"	1/4"	3/8"	1/2"	3/4"	1"	1 1/4"	
Panel mount union LQ3P	 P.51	1	●	-	-	-	-	-	-	●	●	-	-	-	-	-	-	●	-	-	-	-	-	-	-	
		2	●	-	-	-	-	-	-	-	-	●	-	-	-	-	-	-	-	●	-	-	-	-	-	-
		3	●	-	-	-	-	-	-	-	-	-	●	●	-	-	-	-	-	-	●	-	-	-	-	-
		4	●	-	-	-	-	-	-	-	-	-	-	-	●	-	-	-	-	-	-	●	-	-	-	-
		5	●	-	-	-	-	-	-	-	-	-	-	-	-	●	-	-	-	-	-	-	●	-	-	-
		6	●	-	-	-	-	-	-	-	-	-	-	-	-	-	●	-	-	-	-	-	-	●	-	-
Union LQ3U	 P.51	1	●	-	-	-	-	-	-	●	●	-	-	-	-	-	-	●	-	-	-	-	-	-	-	
		2	●	-	-	-	-	-	-	-	-	●	-	-	-	-	-	-	-	●	-	-	-	-	-	
		3	●	-	-	-	-	-	-	-	-	-	●	●	-	-	-	-	-	-	●	-	-	-	-	
		4	●	-	-	-	-	-	-	-	-	-	-	-	●	-	-	-	-	-	-	●	-	-	-	
		5	●	-	-	-	-	-	-	-	-	-	-	-	-	●	-	-	-	-	-	-	●	-	-	
		6	●	-	-	-	-	-	-	-	-	-	-	-	-	-	●	-	-	-	-	-	-	●	-	
		7	-	-	-	-	-	-	-	-	-	-	-	-	-	-	-	-	-	-	-	-	-	-	●	

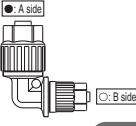
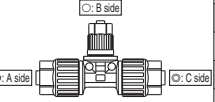



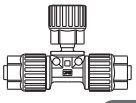
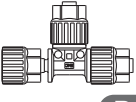
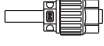

Series	Appearance	Class	Tubing O.D.																						
			Metric size							Inch size															
			ø3	ø4	ø6	ø8	ø10	ø12	ø19	ø25	1/8"	1/4"	3/8"	1/2"	3/4"	1"	1 1/4"								
Union reducing LQ3U-R	 P.52	1	○	●	-	-	-	-	-	-	-	-	-	-	-	-	-	-	-	-	-	-	-	-	
		2	○	○	●	-	-	-	-	-	-	-	○	●	-	-	-	-	-	-	-	-	-	-	-
		3	-	○	○	●/○	●	-	-	-	-	-	○	○	●	-	-	-	-	-	-	-	-	-	-
		4	-	-	-	○	○	●	-	-	-	-	○	○	●	-	-	-	-	-	-	-	-	-	-
		5	-	-	-	-	-	○	●	-	-	-	○	○	○	●	-	-	-	-	-	-	-	-	-
		6	-	-	-	-	-	●	○	●	-	-	-	-	○	○	●	-	-	-	-	-	-	-	-
		7	-	-	-	-	-	-	-	-	-	-	-	-	-	-	-	-	-	-	-	-	○	●	-
Union elbow reducing LQ3E-R	 P.53	1	○	●	-	-	-	-	-	-	-	-	-	-	-	-	-	-	-	-	-	-	-	-	
		2	○	○	●	-	-	-	-	-	-	-	○	●	-	-	-	-	-	-	-	-	-	-	
		3	-	○	○	●/○	●	-	-	-	-	-	○	○	●	-	-	-	-	-	-	-	-	-	-
		4	-	-	-	○	○	●	-	-	-	-	○	○	●	-	-	-	-	-	-	-	-	-	-
		5	-	-	-	-	-	○	●	-	-	-	○	○	○	●	-	-	-	-	-	-	-	-	-
		6	-	-	-	-	-	●	○	●	-	-	-	-	○	○	●	-	-	-	-	-	-	-	-
Union tee reducing LQ3T-R	 P.54	1	○/○	●/○/○	-	-	-	-	-	-	-	-	-	-	-	-	-	-	-	-	-	-	-	-	
		2	○/○	○/○	●/○/○	-	-	-	-	-	-	-	○/○	●/○/○	-	-	-	-	-	-	-	-	-	-	-
		3	-	-	○/○	●/○/○	●/○/○	-	-	-	-	-	○	●/○/○	●/○/○	-	-	-	-	-	-	-	-	-	-
		4	-	-	-	-	○/○	●/○/○	-	-	-	-	○/○	●/○/○	●/○/○	-	-	-	-	-	-	-	-	-	-
		5	-	-	-	-	-	○/○	●/○/○	-	-	-	○/○	●/○/○	●/○/○	●/○/○	-	-	-	-	-	-	-	-	-
		6	-	-	-	-	-	-	○/○	●/○/○	-	-	○/○	●/○/○	●/○/○	●/○/○	●/○/○	-	-	-	-	-	-	-	-

Note) ● : A side tubing O.D. ○ : B side tubing O.D. ◎ : C side tubing O.D.

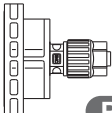
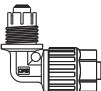
Series	Appearance	Class	Tubing O.D.																						
			Metric size							Inch size															
			ø3	ø4	ø6	ø8	ø10	ø12	ø19	ø25	1/8"	1/4"	3/8"	1/2"	3/4"	1"	1 1/4"								
Space saving union elbow LQ3E-S	 P.56	2	-	-	●	-	-	-	-	-	-	-	-	-	-	-	-	-	●	-	-	-	-	-	
		3	-	-	-	●	●	-	-	-	-	-	-	-	-	-	-	-	-	●	-	-	-	-	-
		4	-	-	-	-	-	●	-	-	-	-	-	-	-	-	-	-	-	-	●	-	-	-	-
		5	-	-	-	-	-	-	●	-	-	-	-	-	-	-	-	-	-	-	-	●	-	-	-
		6	-	-	-	-	-	-	-	●	-	-	-	-	-	-	-	-	-	-	-	-	●	-	-
		7	-	-	-	-	-	-	-	-	-	-	-	-	-	-	-	-	-	-	-	-	-	-	●
		Space saving branch tee LQ3T-SB	 P.57	2	-	-	●	-	-	-	-	-	-	-	-	-	-	-	-	-	●	-	-	-	-
3	-			-	-	●	●	-	-	-	-	-	-	-	-	-	-	-	-	●	-	-	-	-	
4	-			-	-	-	-	●	-	-	-	-	-	-	-	-	-	-	-	-	●	-	-	-	
5	-			-	-	-	-	-	●	-	-	-	-	-	-	-	-	-	-	-	-	●	-	-	
6	-			-	-	-	-	-	-	●	-	-	-	-	-	-	-	-	-	-	-	-	●	-	-
Space saving run tee LQ3T-SR	 P.58			2	-	-	●	-	-	-	-	-	-	-	-	-	-	-	-	-	●	-	-	-	-
		3	-	-	-	●	●	-	-	-	-	-	-	-	-	-	-	-	-	●	-	-	-	-	
		4	-	-	-	-	-	●	-	-	-	-	-	-	-	-	-	-	-	-	●	-	-	-	
		5	-	-	-	-	-	-	●	-	-	-	-	-	-	-	-	-	-	-	-	●	-	-	
		6	-	-	-	-	-	-	-	●	-	-	-	-	-	-	-	-	-	-	-	-	●	-	-
		Tubing extension straight connector LQ3H-T	 P.59	2	-	-	●	-	-	-	-	-	-	-	-	-	-	-	-	-	●	-	-	-	-
3	-			-	-	●	●	-	-	-	-	-	-	-	-	-	-	-	-	●	-	-	-	-	
4	-			-	-	-	-	●	-	-	-	-	-	-	-	-	-	-	-	-	●	-	-	-	
5	-			-	-	-	-	-	●	-	-	-	-	-	-	-	-	-	-	-	-	●	-	-	
6	-			-	-	-	-	-	-	●	-	-	-	-	-	-	-	-	-	-	-	-	●	-	-
7	-			-	-	-	-	-	-	-	-	-	-	-	-	-	-	-	-	-	-	-	-	-	●

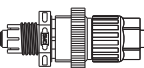
Series LQ3

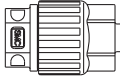
Fluoropolymer Fittings Hyper Fittings / Flare Type

Series	Appearance	Class	Tubing O.D.														
			Metric size								Inch size						
			ø3	ø4	ø6	ø8	ø10	ø12	ø19	ø25	1/8"	1/4"	3/8"	1/2"	3/4"	1"	1 1/4"
Straight adapter LQ3A	 P.60	2	-	-	●	-	-	-	-	-	-	-	●	-	-	-	-
		3	-	-	-	●	●	-	-	-	-	-	-	●	-	-	-
		4	-	-	-	-	-	●	-	-	-	-	-	●	-	-	-
		5	-	-	-	-	-	-	●	-	-	-	-	-	●	-	-
		6	-	-	-	-	-	-	-	●	-	-	-	-	-	●	-
		7	-	-	-	-	-	-	-	-	-	-	-	-	-	-	-
Union flange LQ3F	 P.62	2	-	-	●	-	-	-	-	-	-	●	-	-	-	-	-
		3	-	-	-	-	-	-	-	-	-	-	-	-	-	-	-
		4	-	-	-	-	-	●	-	-	-	-	-	●	-	-	-
		5	-	-	-	-	-	-	●	-	-	-	-	-	●	-	-
		6	-	-	-	-	-	-	-	●	-	-	-	-	-	●	-
		6	-	-	-	-	-	-	-	-	●	-	-	-	-	-	●
Space saving union elbow LQ3E-S	 P.63	2	-	-	●	-	-	-	-	-	-	●	-	-	-	-	-
		3	-	-	-	●	●	-	-	-	-	-	●	-	-	-	-
		4	-	-	-	-	-	●	-	-	-	-	-	●	-	-	-
		5	-	-	-	-	-	-	●	-	-	-	-	-	●	-	-
		6	-	-	-	-	-	-	-	●	-	-	-	-	-	●	-
		6	-	-	-	-	-	-	-	-	●	-	-	-	-	-	●
Space saving union tee LQ3T-S	 P.63	2	-	-	●	-	-	-	-	-	-	●	-	-	-	-	-
		3	-	-	-	●	●	-	-	-	-	-	●	-	-	-	-
		4	-	-	-	-	-	●	-	-	-	-	-	●	-	-	-
		5	-	-	-	-	-	-	●	-	-	-	-	-	●	-	-
		6	-	-	-	-	-	-	-	●	-	-	-	-	-	●	-
		6	-	-	-	-	-	-	-	-	●	-	-	-	-	-	●
Space saving panel mount union LQ3P-S	 P.63	2	-	-	●	-	-	-	-	-	-	●	-	-	-	-	-
		3	-	-	-	●	●	-	-	-	-	-	●	-	-	-	-
		4	-	-	-	-	-	●	-	-	-	-	-	●	-	-	-
		5	-	-	-	-	-	-	●	-	-	-	-	-	●	-	-
		6	-	-	-	-	-	-	-	●	-	-	-	-	-	●	-
		6	-	-	-	-	-	-	-	-	●	-	-	-	-	-	●
Space saving union LQ3U-S	 P.63	2	-	-	●	-	-	-	-	-	-	●	-	-	-	-	-
		3	-	-	-	●	●	-	-	-	-	-	●	-	-	-	-
		4	-	-	-	-	-	●	-	-	-	-	-	●	-	-	-
		5	-	-	-	-	-	-	●	-	-	-	-	-	●	-	-
		6	-	-	-	-	-	-	-	●	-	-	-	-	-	●	-
		6	-	-	-	-	-	-	-	-	●	-	-	-	-	-	●
Blanking plug LQ3-P-1	 P.64	1	●	●	-	-	-	-	-	-	●	-	-	-	-	-	-
		2	-	-	●	-	-	-	-	-	-	●	-	-	-	-	-
		3	-	-	-	●	●	-	-	-	-	-	●	-	-	-	-
		4	-	-	-	-	-	●	-	-	-	-	-	●	-	-	-
		5	-	-	-	-	-	-	●	-	-	-	-	-	●	-	-
		6	-	-	-	-	-	-	-	●	-	-	-	-	-	●	-
		7	-	-	-	-	-	-	-	-	●	-	-	-	-	-	-
Tubing plug LQ3-P-2	 P.64	1	●	●	-	-	-	-	-	-	●	-	-	-	-	-	-
		2	-	-	●	-	-	-	-	-	-	●	-	-	-	-	-
		3	-	-	-	●	●	-	-	-	-	-	●	-	-	-	-
		4	-	-	-	-	-	●	-	-	-	-	-	●	-	-	-
		5	-	-	-	-	-	-	●	-	-	-	-	-	●	-	-
		6	-	-	-	-	-	-	-	●	-	-	-	-	-	●	-
		7	-	-	-	-	-	-	-	-	●	-	-	-	-	-	-
Nut LQ3-N	 P.64	1	●	●	-	-	-	-	-	-	●	-	-	-	-	-	-
		2	-	-	●	-	-	-	-	-	-	●	-	-	-	-	-
		3	-	-	-	●	●	-	-	-	-	-	●	-	-	-	-
		4	-	-	-	-	-	●	-	-	-	-	-	●	-	-	-
		5	-	-	-	-	-	-	●	-	-	-	-	-	●	-	-
		6	-	-	-	-	-	-	-	●	-	-	-	-	-	●	-
		7	-	-	-	-	-	-	-	-	●	-	-	-	-	-	-

Needle Valve **P.65**

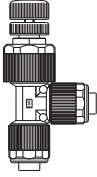
Series	Appearance	Class	Tubing O.D.									
			Metric size					Inch size				
			ø4	ø6	ø8	ø10	ø12	1/8"	3/16"	1/4"	3/8"	1/2"
Needle valve LVN		2	●	○	-	-	-	●	●	○	-	-
		3	-	●	●	○	-	-	-	●	○	-
		4	-	-	-	●	○	-	-	-	●	○

Note) ○Basic size ●With reducer

Bore Through Connector **P.68**

Series	Appearance	Class	Tubing O.D.													
			Metric size							Inch size						
			ø3	ø4	ø6	ø8	ø10	ø12	ø19	ø25	1/8"	1/4"	3/8"	1/2"	3/4"	1"
Bore through connector LQHB		1	●	●	-	-	-	-	-	-	-	●	-	-	-	-
		2	-	-	●	-	-	-	-	-	-	-	●	-	-	-
		3	-	-	-	●	●	-	-	-	-	-	●	-	-	-
		4	-	-	-	-	-	●	-	-	-	-	-	●	-	-
		5	-	-	-	-	-	-	●	-	-	-	-	-	●	-
		6	-	-	-	-	-	-	-	●	-	-	-	-	-	-

Fluoropolymer Tubing **P.73**

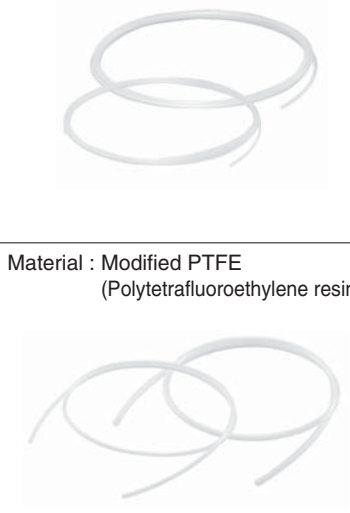
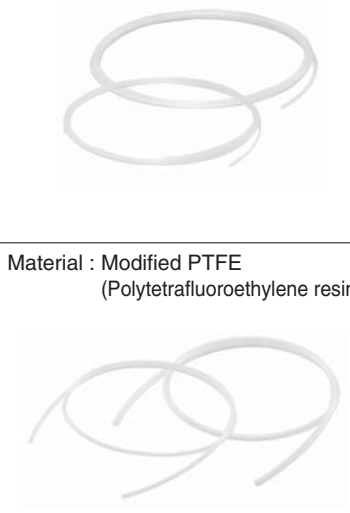
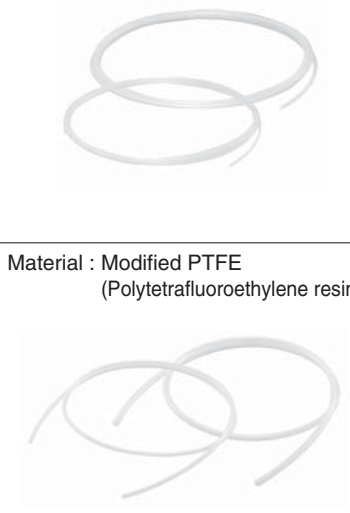
Series	Tubing O.D.		
TL	Material : Super PFA	Metric size	ø4
			ø6
TIL		Inch size	ø8
			ø10
			ø12
			ø19
			1/8"
TD	Material : Modified PTFE (Polytetrafluoroethylene resin)	Metric size	3/16"
			1/4"
			3/8"
			1/2"
			ø4
TID		Inch size	ø6
			ø8
			ø10
			ø12
			1/8"
TH	Material : FEP	Metric size	3/16"
			1/4"
			3/8"
			1/2"
			ø4
TIH		Inch size	ø6
			ø8
			ø10
			ø12
			1/8"
			3/16"
			1/4"
3/8"			
1/2"			
3/4"			

Fluoropolymer Fittings Hyper Fittings

Series LQ1

RoHS

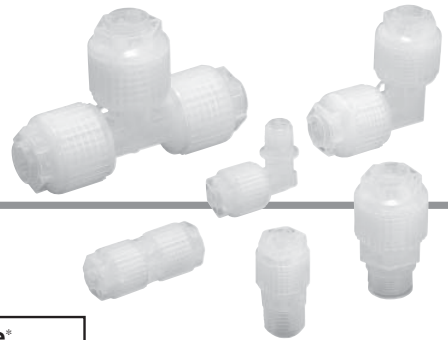

How to Order

Threaded connection

LQ1 H 11 [] - M [] - []

Fitting type

Symbol	Type
H	Connector
L	Elbow
R	Run tee
B	Branch tee

Thread type*

Symbol	Type
—	R, Rc
N	NPT

* 310 size can be used only with R thread.

Piping type

Symbol	Type
M	Male
F	Female

Packaging

Symbol	Packaging
—	Clean packaging equivalent to Class M3.5
1	Standard packaging equivalent to Class M5.5

Size combination

Symbol Class	Symbol No.	Applicable tubing size (mm)	Tubing O.D.	Symbol Class	Symbol No.	Applicable tubing size (inch)	Tubing O.D.
1	1	4 x 3	1/8"	1	A	1/8" x 0.086"	1/8"
1	2	3 x 2	1/8"	2	A	1/4" x 5/32"	1/8"
2	1	6 x 4	1/8"	2	B	3/16" x 1/8"	1/8"
2	2	4 x 3	1/8"	2	C	1/8" x 0.086"	1/8"
2	C	3 x 2	1/8"	2	D	1/4" x 5/32"	1/8"
2	3	6 x 4	1/4"	2	E	3/16" x 1/8"	1/4"
2	4	4 x 3	1/4"	2	F	1/8" x 0.086"	1/4"
2	F	3 x 2	1/4"	3	A	3/8" x 1/4"	1/4"
3	1	10 x 8	1/4"	3	B	1/4" x 5/32"	1/4"
3	2	8 x 6	1/4"	3	C	3/8" x 1/4"	1/4"
3	3	6 x 4	1/4"	3	D	1/4" x 5/32"	3/8"
3	4	10 x 8	3/8"	3	E	1/8" x 0.086"	3/8"
3	5	8 x 6	3/8"	3	F	3/8" x 1/4"	3/8"
3	6	6 x 4	3/8"	4	A	1/2" x 3/8"	3/8"
3	7	4 x 3	3/8"	4	B	3/8" x 1/4"	3/8"
3	E	3 x 2	3/8"	4	C	1/2" x 3/8"	1/2"
3	9	10 x 8	1/8"	4	D	3/8" x 1/4"	1/2"
3	10	8 x 6	1/8"	4	E	1/4" x 5/32"	1/2"
4	1	12 x 10	3/8"	4	F	1/8" x 0.086"	1/2"
4	2	10 x 8	3/8"	4	G	1/2" x 3/8"	1/4"
4	3	12 x 10	1/2"	5	A	3/4" x 5/8"	1/2"
4	4	10 x 8	1/2"	5	B	1/2" x 3/8"	1/2"
4	5	8 x 6	1/2"	5	C	3/4" x 5/8"	3/4"
4	6	6 x 4	1/2"	5	D	1/2" x 3/8"	3/4"
4	F	3 x 2	1/2"	5	E	3/8" x 1/4"	3/4"
4	9	12 x 10	1/4"	5	F	1/4" x 5/32"	3/4"
5	1	19 x 16	1/2"	5	G	3/4" x 5/8"	1/4"
5	2	12 x 10	1/2"	5	H	3/4" x 5/8"	3/8"
5	3	19 x 16	3/4"	6	A	1" x 7/8"	3/4"
5	4	12 x 10	3/4"	6	B	3/4" x 5/8"	3/4"
5	5	10 x 8	3/4"	6	C	1" x 7/8"	3/4"
5	7	6 x 4	3/4"	6	D	3/4" x 5/8"	1"
5	8	19 x 16	1/4"	6	E	1/2" x 3/8"	1"
5	9	19 x 16	3/8"	6	F	1" x 7/8"	1/2"
6	1	25 x 22	3/4"				
6	2	19 x 16	3/4"				
6	3	25 x 22	1"				
6	4	19 x 16	1"				
6	5	12 x 10	1"				
6	6	25 x 22	1/2"				

For different diameter (on B side)

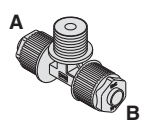
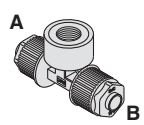
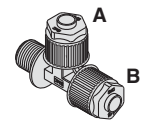
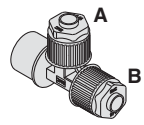
Symbol	Application
—	Same tubing size
Refer to the applicable tubing table.	Different diameter tubing can be selected within the same body class.
LQ1B	
Branch tee male	Branch tee female
	
LQ1R	
Run tee male	Run tee female
	

The table of combination is the same as that for A side.

Note 1) Only branch tees and run tees can take different diameters.

Note 2) Use of different diameters is not available with size 1.



Note 1) For each body class, the second and later numbers or symbols indicate reducing. However, in case of size 1, the tubing cannot be changed by reducing.

Note 2) Combinations will differ depending on the type of each fitting. For the availability of combinations, refer to pages 4 to 11. These are produced upon receipt of order by part number.

Note 3) For details of the applicable tubing sizes, refer to page 72.

How to Order

Tubing connection

LQ1 E 11

Fitting type

Symbol	Type
E	Union elbow
T	Union tee
P	Panel mount union
U	Union
F	Union flange

Combination of different diameter (on B side)

Symbol	Applicable tubing size (mm)
1 1	4 x 3
1 2	3 x 2
2 1	6 x 4
2 2	4 x 3
2 C	3 x 2
3 1	10 x 8
3 2	8 x 6
3 3	6 x 4
4 1	12 x 10
4 2	10 x 8
5 1	19 x 16
5 2	12 x 10
6 1	25 x 22
6 2	19 x 16

Packaging

Symbol	Packaging
—	Clean packaging equivalent to Class M3.5
1	Standard packaging equivalent to Class M5.5

Symbol	Applicable tubing size (inch)
1 A	1/8" x 0.086"
2 A	1/4" x 5/32"
2 B	3/16" x 1/8"
2 C	1/8" x 0.086"
3 A	3/8" x 1/4"
3 B	1/4" x 5/32"
4 A	1/2" x 3/8"
4 B	3/8" x 1/4"
5 A	3/4" x 5/8"
5 B	1/2" x 3/8"
6 A	1" x 7/8"
6 B	3/4" x 5/8"



Note 1) For each body class, the second and later numbers or symbols indicate reducing. However, use of different diameters is not available with size 1.

Note 2) For details of the applicable tubing sizes, refer to page 72.

Size combination

Symbol	Applicable tubing size (mm)	Symbol	Applicable tubing size (inch)	Applicable flange
1 1	4 x 3	1 A	1/8" x 0.086"	—
1 2	3 x 2	—	—	—
2 1	6 x 4	2 A	1/4" x 5/32"	—
2 2	4 x 3	2 B	3/16" x 1/8"	—
2 C	3 x 2	2 C	1/8" x 0.086"	—
3 1	10 x 8	3 A	3/8" x 1/4"	—
3 2	8 x 6	3 B	1/4" x 5/32"	—
3 3	6 x 4	4 A	1/2" x 3/8"	15A
4 1	12 x 10	4 B	3/8" x 1/4"	15A
4 2	10 x 8	5 A	3/4" x 5/8"	20A
5 1	19 x 16	5 B	1/2" x 3/8"	20A
5 2	12 x 10	6 A	1" x 7/8"	25A
6 1	25 x 22	6 B	3/4" x 5/8"	25A
6 2	19 x 16			



Note 1) For each body class, the second and later numbers or symbols indicate reducing. However, in case of size 1, the tubing cannot be changed by reducing.

Note 2) Sizes 1 to 3 are not available for the union flange.

Note 3) For Union flange, nut sizes 4 and 5 are as shown below.

LQ1F4□: LQ-4N□□

LQ1F5□: LQ-5N□□

Note 4) Combinations will differ depending on the type of each fitting. For the availability of combinations, refer to pages 12 to 15.

Note 5) For details of the applicable tubing sizes, refer to page 72.

Symbol	Application
—	Same tubing size
Refer to the applicable tubing table.	Different diameter tubing can be selected within the same body class.
Union elbow LQ1E	Union tee LQ1T
Panel mount union LQ1P	Union LQ1U

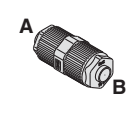
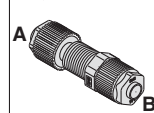
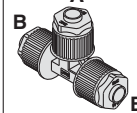
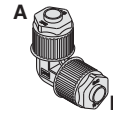

Different diameter tubing order example

Different diameter tubing (with plug-in reducer) can be selected within the same body class.

(Example) Union elbow

Body class 3

A side: $\varnothing 10 \times \varnothing 8$

B side: $\varnothing 8 \times \varnothing 6$

Order as shown below.

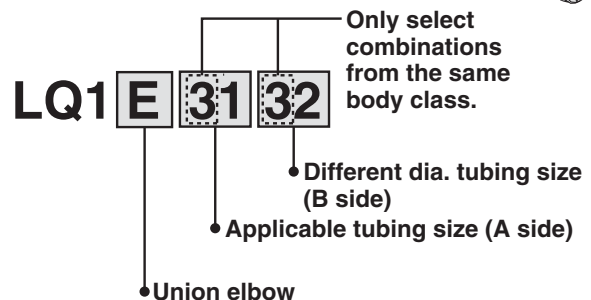
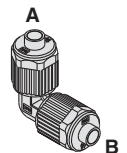

LQ1

LQ3

LVN

LQHB

TL/TIL

TD/TID

TH/THH

Applicable Fluid

Precautions

Series LQ1

Specifications

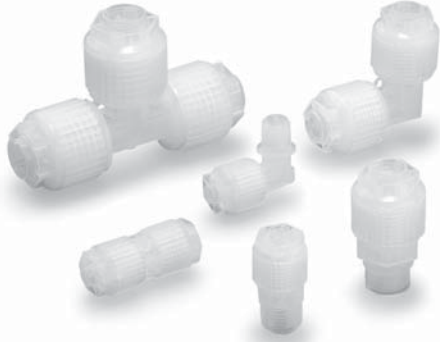

Feature	Model	LQ1□10	LQ1□20	LQ1□30	LQ1□40	LQ1□50	LQ1□60
Material		NEW PFA ^{Note)}					
Maximum operating pressure (at 20°C)		1.0 MPa					
Proof pressure		Refer to the withstand pressure and heat resistance performance curves.					
Operating temperature		0 to 200°C					

Note) For products produced upon receipt of order, the fitting body is made of PTFE.

Burst Pressure and Heat Resistance Performance

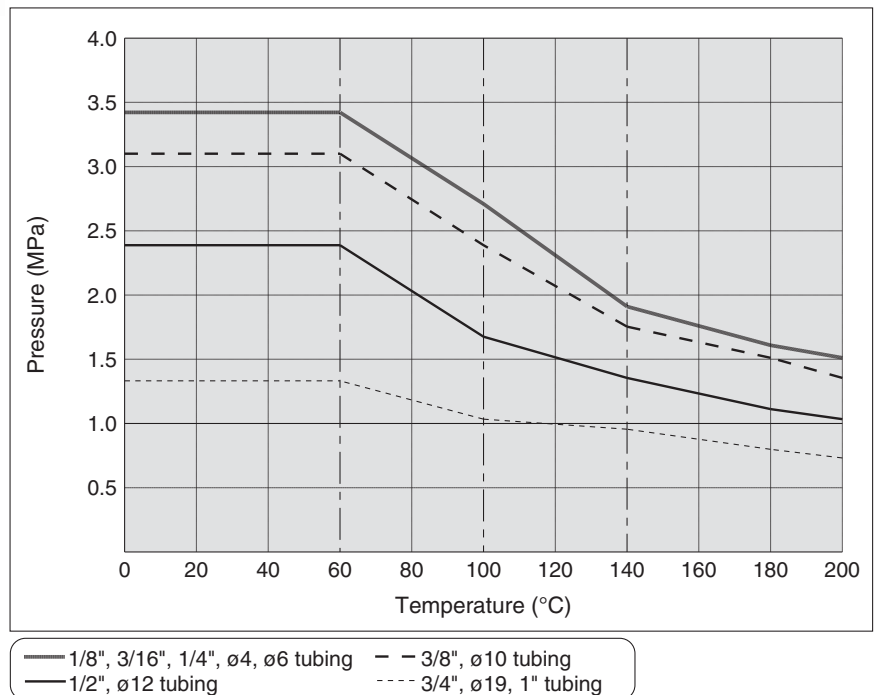

Piping

⚠ Caution

1. Connect tubing with special tools

Refer to the pamphlet "High-Purity Fluoropolymer Fittings Hyper fitting/Series LQ1, 2 Work Procedure Instructions" (M-E05-1) for connecting tubing and special tools. (Downloadable from our web site.)

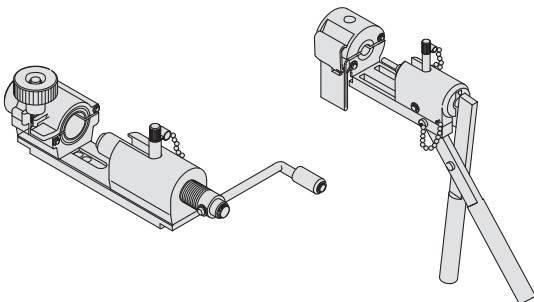

2. Tighten the nut to the end surface of the body. As a guide, refer to the proper tightening torque shown below.

Tightening torque for piping

Body class	Torque (N·m)
2	0.3 to 0.4
3	0.8 to 1.0
4	1.0 to 1.2
5	2.5 to 3.0
6	5.5 to 6.0

Note) In the case of body class 1, the nut should be tightened manually.

Dimensions

Male Connector: LQ1H-M

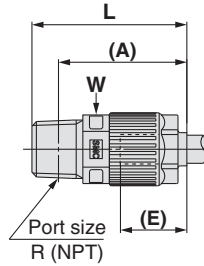
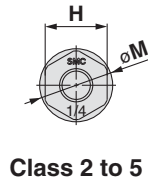
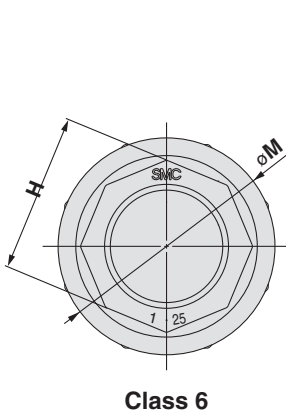

(A) shows the reference dimension after connection.
 (E) shows the approximate dimension of the inserted tubing from the end of the nut.
 "W" is width across flats dimension.

Metric sizes

Model	Applicable tubing O.D.	Connection threads R/NPT	A	E	H	L	M	W
LQ1H11-M	ø4	1/8"	21	10	—	25	11.5	10
LQ1H12-M	ø3							
LQ1H21-M	ø6	1/8"	31.5	15	14	35	16.5	14
LQ1H22-M	ø4							
LQ1H2C-M	ø3							
LQ1H23-M	ø6	1/4"	29	20	17	42.5	23	19
LQ1H24-M	ø4							
LQ1H2F-M	ø3	3/8"	36	31.5	15	14	37.6	16.5
LQ1H31-M	ø10							
LQ1H32-M	ø8	1/4"	36.5	20	17	42.5	23	19
LQ1H33-M	ø6							
LQ1H34-M	ø10	3/8"	36	31.5	15	14	37.6	16.5
LQ1H35-M	ø8							
LQ1H36-M	ø6	1/8"	34.5	20	17	38	23	23
LQ1H37-M	ø4							
LQ1H3E-M	ø3	3/8"	46	24	21	52	28	23
LQ1H39-M	ø10							
LQ1H310-M	ø8	1/2"	39.5	20	17	47.5	23	23
LQ1H41-M	ø12							
LQ1H42-M	ø10	3/8"	44	24	21	52	28	23
LQ1H43-M	ø12							
LQ1H44-M	ø10	1/2"	39.5	20	17	47.5	23	23
LQ1H45-M	ø8							
LQ1H46-M	ø6	1/4"	42	24	21	48	28	28
LQ1H4F-M	ø3							
LQ1H49-M	ø12	1/2"	55	29	26	62.5	39	32
LQ1H51-M	ø19							
LQ1H52-M	ø12	3/4"	53.5	43.5	20	17	52.5	23
LQ1H53-M	ø19							
LQ1H54-M	ø12	1/4"	52	29	26	58	39	46
LQ1H55-M	ø10							
LQ1H57-M	ø6	3/8"	72	39.5	36	81	49	46
LQ1H58-M	ø19							
LQ1H59-M	ø19	1"	71	61	29	26	71	39
LQ1H61-M	ø25							
LQ1H62-M	ø19	1/2"	69.5	39.5	36	77.5	49	46
LQ1H63-M	ø25							
LQ1H64-M	ø19	1"	61	29	26	71	39	46
LQ1H65-M	ø12							
LQ1H66-M	ø25	1/2"	69.5	39.5	36	77.5	49	46

Inch sizes

Model	Applicable tubing O.D.	Connection threads R/NPT	A	E	H	L	M	W
LQ1H1A-M	1/8"	1/8"	21	10	—	25	11.5	10
LQ1H2A-M	1/4"	1/8"	31.5	15	14	35	16.5	14
LQ1H2B-M	3/16"							
LQ1H2C-M	1/8"							
LQ1H2D-M	1/4"	1/4"	29	20	17	42.5	23	19
LQ1H2E-M	3/16"							
LQ1H2F-M	1/8"	3/8"	36	31.5	15	14	37.6	16.5
LQ1H3A-M	3/8"							
LQ1H3B-M	1/4"	1/8"	34.5	20	17	38	23	23
LQ1H3C-M	3/8"							
LQ1H3D-M	1/4"	3/8"	46	24	21	52	28	23
LQ1H3E-M	1/8"							
LQ1H3F-M	3/8"	1/2"	44	39.5	20	17	47.5	23
LQ1H3G-M	1/8"							
LQ1H4A-M	1/2"	1/4"	42	24	21	48	28	28
LQ1H4B-M	3/8"							
LQ1H4C-M	1/2"	1/2"	55	29	26	62.5	39	32
LQ1H4D-M	3/8"							
LQ1H4E-M	1/4"	3/4"	53.5	43.5	20	17	52.5	23
LQ1H4F-M	1/8"							
LQ1H4G-M	1/2"	1/4"	42	24	21	48	28	28
LQ1H5A-M	3/4"							
LQ1H5B-M	1/2"	1/2"	55	29	26	62.5	39	32
LQ1H5C-M	3/4"							
LQ1H5D-M	1/2"	3/4"	53.5	43.5	20	17	52.5	23
LQ1H5E-M	3/8"							
LQ1H5F-M	1/4"	1/4"	52	29	26	58	39	46
LQ1H5G-M	3/4"							
LQ1H5H-M	3/8"	3/4"	72	39.5	36	81	49	46
LQ1H6A-M	1"							
LQ1H6B-M	3/4"	1"	71	61	29	26	71	39
LQ1H6C-M	1"							
LQ1H6D-M	3/4"	1/2"	69.5	39.5	36	77.5	49	46
LQ1H6E-M	1/2"							
LQ1H6F-M	1"	1/2"	69.5	39.5	36	77.5	49	46

LQ1

LQ3

LVN

LQHB

TL/TIL

TD/TID

TH/THH

Applicable Fluid

Precautions

Series LQ1

Dimensions

Female Connector: LQ1H-F

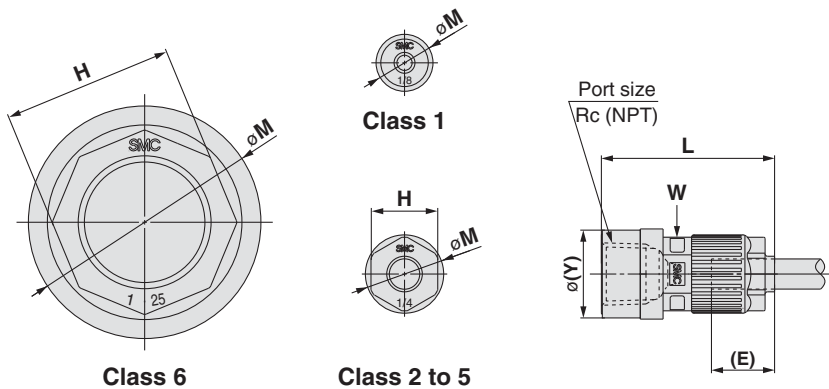

(E) shows the reference of the inserted tubing from the end of the nut.
"W" is width across flats dimension.

Metric sizes

Model	Applicable tubing O.D.	Connection threads Rc/NPT	E	H	L	M	W	Y
LQ1H11-F□	ø4	1/8"	10	—	26.5	11.5	10	18.5
LQ1H12-F□	ø3							
LQ1H21-F□	ø6	1/8"	15	14	35	16.5	14	18.5
LQ1H22-F□	ø4							
LQ1H2C-F□	ø3	1/4"	15	14	36.5	16.5	14	21.5
LQ1H23-F□	ø6							
LQ1H24-F□	ø4	1/4"	15	14	36.5	16.5	14	21.5
LQ1H2F-F□	ø3							
LQ1H31-F□	ø10	1/4"	20	17	42.5	23	19	25
LQ1H32-F□	ø8							
LQ1H33-F□	ø6	3/8"	20	17	42.5	23	19	25
LQ1H34-F□	ø10							
LQ1H35-F□	ø8	3/8"	20	17	42.5	23	19	25
LQ1H36-F□	ø6							
LQ1H39-F□	ø10	1/8"	24	21	47.5	28	23	29.5
LQ1H310-F□	ø8							
LQ1H41-F□	ø12	3/8"	24	21	47.5	28	23	29.5
LQ1H42-F□	ø10							
LQ1H43-F□	ø12	1/2"	20	17	45.5	23	19	25
LQ1H44-F□	ø10							
LQ1H45-F□	ø8	1/2"	20	17	45.5	23	19	25
LQ1H46-F□	ø6							
LQ1H49-F□	ø12	1/4"	29	26	56.5	39	32	21.5
LQ1H410-F□	ø12	1/8"	24	21	46.5	28	23	18.5
LQ1H51-F□	ø19	1/2"	29	26	58.5	39	32	36
LQ1H52-F□	ø12							
LQ1H53-F□	ø19	3/4"	29	26	60	39	32	36
LQ1H54-F□	ø12							
LQ1H58-F□	ø19	1/4"	29	26	56.5	39	32	21.5
LQ1H59-F□	ø19	3/8"	29	26	56	39	32	25
LQ1H61-F□	ø25	3/4"	39.5	36	75	49	46	44.5
LQ1H62-F□	ø19							
LQ1H63-F□	ø25	1"	39.5	36	78.5	49	46	44.5
LQ1H64-F□	ø19							

Inch sizes

Model	Applicable tubing O.D.	Connection threads Rc/NPT	E	H	L	M	W	Y
LQ1H1A-F□	1/8"	1/8"	10	—	26.5	11.5	10	18.5
LQ1H2A-F□	1/4"	1/8"	15	14	35	16.5	14	18.5
LQ1H2B-F□	3/16"							
LQ1H2C-F□	1/8"	1/4"	15	14	36.5	16.5	14	21.5
LQ1H2D-F□	1/4"							
LQ1H2E-F□	3/16"	1/4"	15	14	36.5	16.5	14	21.5
LQ1H2F-F□	1/8"							
LQ1H3A-F□	3/8"	1/4"	20	17	42.5	23	19	25
LQ1H3B-F□	1/4"							
LQ1H3C-F□	3/8"	3/8"	20	17	42.5	23	19	25
LQ1H3D-F□	1/4"							
LQ1H3F-F□	3/8"	1/8"	20	17	42.5	23	19	18.5
LQ1H4A-F□	1/2"	3/8"	24	21	47.5	28	23	29.5
LQ1H4B-F□	3/8"							
LQ1H4C-F□	1/2"	1/2"	24	21	50	28	23	29.5
LQ1H4D-F□	3/8"							
LQ1H4E-F□	1/4"	1/2"	20	17	45.5	23	19	25
LQ1H4G-F□	1/2"	1/4"	29	26	56.5	39	32	21.5
LQ1H4H-F□	1/2"	1/8"	24	21	46.5	28	23	18.5
LQ1H5A-F□	3/4"	1/2"	29	26	58.5	39	32	36
LQ1H5B-F□	1/2"							
LQ1H5C-F□	3/4"	3/4"	29	26	60	39	32	36
LQ1H5D-F□	1/2"							
LQ1H5G-F□	3/4"	1/4"	29	26	56.5	39	32	21.5
LQ1H5H-F□	3/4"	3/8"	29	26	56	39	32	25
LQ1H6A-F□	1"	3/4"	39.5	36	75	49	46	44.5
LQ1H6B-F□	3/4"							
LQ1H6C-F□	1"	1"	39.5	36	78.5	49	46	44.5
LQ1H6D-F□	3/4"							

Male Elbow: LQ1L-M

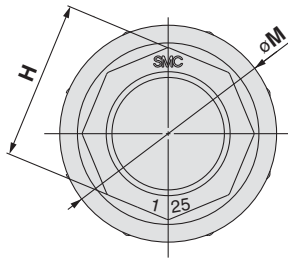

Class 6

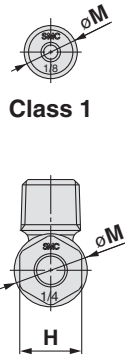

Class 1

Class 2 to 5

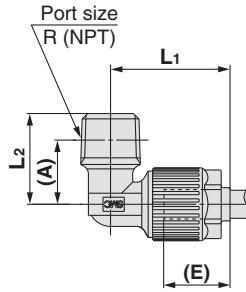

(A) shows the reference dimension after connection.
(E) shows the approximate dimension of the inserted tubing from the end of the nut.

Metric sizes

Model	Applicable tubing O.D.	Connection threads R/NPT	A	E	H	L ₁	L ₂	M
LQ1L11-M□	ø4	1/8"	11.5	10	—	18	15	11.5
LQ1L12-M□	ø3	1/8"	11.5	10	—	18	15	11.5
LQ1L21-M□	ø6	1/8"	14.5	15	14	27	20.5	16.5
LQ1L22-M□	ø4							
LQ1L2C-M□	ø3							
LQ1L23-M□	ø6	1/4"	20	20	17	35	26.5	23
LQ1L24-M□	ø4							
LQ1L2F-M□	ø3							
LQ1L31-M□	ø10	1/4"	21.1	15	14	31.6	27.1	16.5
LQ1L32-M□	ø8							
LQ1L33-M□	ø6							
LQ1L34-M□	ø10	3/8"	20.6	20	17	36.6	24.1	23
LQ1L35-M□	ø8							
LQ1L36-M□	ø6							
LQ1L37-M□	ø4	3/8"	25	24	21	45	33	28
LQ1L3E-M□	ø3							
LQ1L39-M□	ø10							
LQ1L310-M□	ø8	1/8"	24.1	20	17	38.5	32.1	23
LQ1L41-M□	ø12							
LQ1L42-M□	ø10							
LQ1L43-M□	ø12	1/2"	17.5	15	14	30	25.5	16.5
LQ1L44-M□	ø10							
LQ1L45-M□	ø8							
LQ1L46-M□	ø6	3/4"	22.6	24	21	43	28.6	28
* LQ1L47-M□	ø4							
* LQ1L4F-M□	ø3							
LQ1L49-M□	ø12	1/4"	34	39.5	36	53	40	49
LQ1L51-M□	ø19							
LQ1L52-M□	ø12							
LQ1L53-M□	ø19	1/2"	29	26	54	40	39	
LQ1L54-M□	ø12							
LQ1L55-M□	ø10							
LQ1L56-M□	ø8	3/4"	20	17	44	39.5	23	
LQ1L57-M□	ø6							
* LQ1L59-M□	ø19							
LQ1L61-M□	ø25	3/8"	35	39.5	36	68.5	46	49
LQ1L62-M□	ø19							
LQ1L63-M□	ø25							
LQ1L64-M□	ø19	1"	37	29	26	60	47	39
LQ1L65-M□	ø12							
* LQ1L67-M□	ø25							

Note) Products marked "*" are produced upon receipt of order.

Inch sizes

Model	Applicable tubing O.D.	Connection threads R/NPT	A	E	H	L ₁	L ₂	M
LQ1L1A-M□	1/8"	1/8"	11.5	10	—	18	15	11.5
LQ1L2A-M□	1/4"	1/8"	14.5	15	14	27	20.5	16.5
LQ1L2B-M□	3/16"							
LQ1L2C-M□	1/8"							
LQ1L2D-M□	1/4"	1/4"	20	20	17	35	26.5	23
LQ1L2E-M□	3/16"							
LQ1L2F-M□	1/8"							
LQ1L3A-M□	3/8"	1/4"	21.1	15	14	31.6	27.1	16.5
LQ1L3B-M□	1/4"							
LQ1L3C-M□	3/8"							
LQ1L3D-M□	1/4"	3/8"	20.6	20	17	36.6	24.1	23
LQ1L3E-M□	1/8"							
LQ1L3F-M□	3/8"							
LQ1L4A-M□	1/2"	3/8"	25	24	21	45	33	28
LQ1L4B-M□	3/8"							
LQ1L4C-M□	1/2"							
LQ1L4D-M□	3/8"	1/2"	24.1	20	17	38.5	32.1	23
LQ1L4E-M□	1/4"							
* LQ1L4F-M□	1/8"							
LQ1L4G-M□	1/2"	1/4"	22.6	24	21	43	28.6	28
LQ1L5A-M□	3/4"	1/2"	30.5	29	26	54	40	39
LQ1L5B-M□	1/2"							
LQ1L5C-M□	3/4"							
LQ1L5D-M□	1/2"	3/4"	20	17	44	39.5	23	
LQ1L5E-M□	3/8"							
LQ1L5F-M□	1/4"							
* LQ1L5H-M□	3/4"	3/8"	34	39.5	36	53	40	49
LQ1L6A-M□	1"	3/4"	35	39.5	36	68.5	46	49
LQ1L6B-M□	3/4"							
LQ1L6C-M□	1"							
LQ1L6D-M□	3/4"	1"	37	29	26	60	47	39
LQ1L6E-M□	1/2"							
* LQ1L6G-M□	1"							
		3/8"	34	39.5	36	53	40	49

Note) Products marked "*" are produced upon receipt of order.

Series LQ1

Dimensions

Female Elbow: LQ1L-F

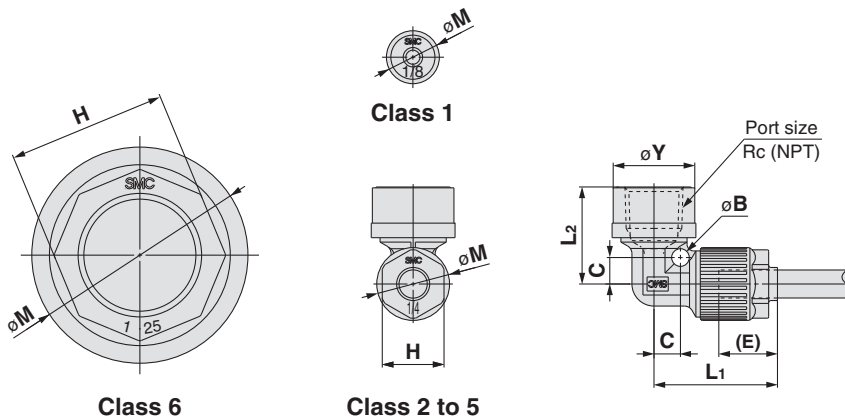

(E) shows the reference dimension of the inserted tubing from the end of the nut.

Metric sizes

Model	Applicable tubing O.D.	Connection threads Rc/NPT	B	C	E	H	L ₁	L ₂	M	Y
LQ1L11-F□	ø4	1/8"	2	4	10	—	18.5	16	11.5	18.5
LQ1L12-F□	ø3	1/8"	2	4	10	—	18.5	16	11.5	18.5
LQ1L21-F□	ø6	1/8"	4	6	15	14	28	19.5	16.5	18.5
LQ1L22-F□	ø4	1/8"	4	6	15	14	28	19.5	16.5	18.5
LQ1L2C-F□	ø3	1/8"	4	6	15	14	28	19.5	16.5	18.5
LQ1L23-F□	ø6	1/4"	4	6	15	14	28	19.5	16.5	18.5
LQ1L24-F□	ø4	1/4"	4	6	15	14	28	19.5	16.5	18.5
LQ1L2F-F□	ø3	1/4"	4	6	15	14	28	19.5	16.5	18.5
LQ1L31-F□	ø10	1/4"	5	9	20	17	36.5	24.5	23	21.5
LQ1L32-F□	ø8	1/4"	5	9	20	17	36.5	24.5	23	21.5
LQ1L33-F□	ø6	1/4"	5	9	20	17	36.5	24.5	23	21.5
LQ1L34-F□	ø10	3/8"	5	9	20	17	36.5	24.5	23	21.5
LQ1L35-F□	ø8	3/8"	5	9	20	17	36.5	24.5	23	21.5
LQ1L36-F□	ø6	3/8"	5	9	20	17	36.5	24.5	23	21.5
LQ1L3E-F□	ø3	3/8"	5	9	20	17	36.5	24.5	23	21.5
* LQ1L39-F□	ø10	1/8"	5	9	20	17	36.6	21.8	23	18.5
* LQ1L310-F□	ø8	1/8"	5	9	20	17	36.6	21.8	23	18.5
LQ1L41-F□	ø12	3/8"	6	9	24	21	43	30.5	28	29.5
LQ1L42-F□	ø10	3/8"	6	9	24	21	43	30.5	28	29.5
LQ1L43-F□	ø12	1/2"	6	9	24	21	43	30.5	28	29.5
LQ1L44-F□	ø10	1/2"	6	9	24	21	43	30.5	28	29.5
LQ1L49-F□	ø12	1/4"	6	9	24	21	43	30.5	28	29.5
LQ1L410-F□	ø12	1/8"	6	9	24	21	43	30.5	28	29.5
LQ1L51-F□	ø19	1/2"	7	14	29	26	54	37	39	36
LQ1L52-F□	ø12	1/2"	7	14	29	26	54	37	39	36
LQ1L53-F□	ø19	3/4"	7	14	29	26	54	37	39	36
LQ1L54-F□	ø12	3/4"	7	14	29	26	54	37	39	36
LQ1L59-F□	ø19	3/8"	7	14	29	26	54	37	39	36
LQ1L61-F□	ø25	3/4"	8	18	39.5	36	69.5	42.5	49	44.5
LQ1L62-F□	ø19	3/4"	8	18	39.5	36	69.5	42.5	49	44.5
LQ1L63-F□	ø25	1"	8	18	39.5	36	69.5	42.5	49	44.5
LQ1L64-F□	ø19	1"	8	18	39.5	36	69.5	42.5	49	44.5

Note) Products marked "*" are produced upon receipt of order.

Inch sizes

Model	Applicable tubing O.D.	Connection threads Rc/NPT	B	C	E	H	L ₁	L ₂	M	Y
LQ1L1A-F□	1/8"	1/8"	2	4	10	—	18.5	16	11.5	18.5
LQ1L2A-F□	1/4"	1/8"	4	6	15	14	28	19.5	16.5	18.5
LQ1L2B-F□	3/16"	1/8"	4	6	15	14	28	19.5	16.5	18.5
LQ1L2C-F□	1/8"	1/8"	4	6	15	14	28	19.5	16.5	18.5
LQ1L2D-F□	1/4"	1/4"	4	6	15	14	28	19.5	16.5	18.5
LQ1L2E-F□	3/16"	1/4"	4	6	15	14	28	19.5	16.5	18.5
LQ1L2F-F□	1/8"	1/4"	4	6	15	14	28	19.5	16.5	18.5
LQ1L3A-F□	3/8"	1/4"	5	9	20	17	36.5	24.5	23	21.5
LQ1L3B-F□	1/4"	1/4"	5	9	20	17	36.5	24.5	23	21.5
LQ1L3C-F□	3/8"	3/8"	5	9	20	17	36.5	24.5	23	21.5
LQ1L3D-F□	1/4"	3/8"	5	9	20	17	36.5	24.5	23	21.5
LQ1L3E-F□	1/8"	3/8"	5	9	20	17	36.5	24.5	23	21.5
* LQ1L3F-F□	3/8"	1/8"	5	9	20	17	36.6	21.8	23	18.5
LQ1L4A-F□	1/2"	3/8"	6	9	24	21	43	30.5	28	29.5
LQ1L4B-F□	3/8"	3/8"	6	9	24	21	43	30.5	28	29.5
LQ1L4C-F□	1/2"	1/2"	6	9	24	21	43	30.5	28	29.5
LQ1L4D-F□	3/8"	1/2"	6	9	24	21	43	30.5	28	29.5
LQ1L4G-F□	1/2"	1/4"	6	9	24	21	43	30.5	28	29.5
LQ1L4H-F□	1/2"	1/8"	6	9	24	21	43	30.5	28	29.5
LQ1L5A-F□	3/4"	1/2"	7	14	29	26	54	37	39	36
LQ1L5B-F□	1/2"	1/2"	7	14	29	26	54	37	39	36
LQ1L5C-F□	3/4"	3/4"	7	14	29	26	54	37	39	36
LQ1L5D-F□	1/2"	3/4"	7	14	29	26	54	37	39	36
LQ1L5H-F□	3/4"	3/8"	7	14	29	26	54	37	39	36
LQ1L6A-F□	1"	3/4"	8	18	39.5	36	69.5	42.5	49	44.5
LQ1L6B-F□	3/4"	3/4"	8	18	39.5	36	69.5	42.5	49	44.5
LQ1L6C-F□	1"	1"	8	18	39.5	36	69.5	42.5	49	44.5
LQ1L6D-F□	3/4"	1"	8	18	39.5	36	69.5	42.5	49	44.5

Note) Products marked "*" are produced upon receipt of order.

Male Run Tee: LQ1R-M

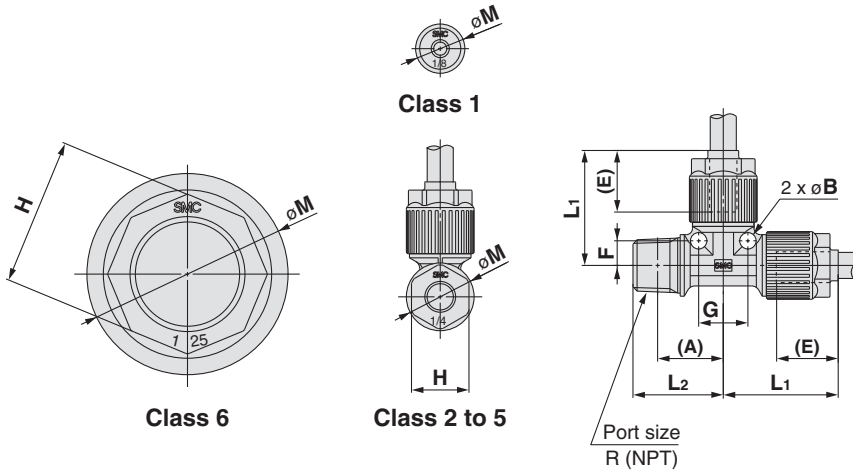

(A) shows the reference dimension after connection.
(E) shows the approximate dimension of the inserted tubing from the end of the nut.

Metric sizes

Model	Applicable tubing O.D.	Connection threads R/NPT	A	B	E	F	G	H	L ₁	L ₂	M
LQ1R11-M	ø4	1/8"	12	2	10	4	8	—	18.5	15.5	11.5
LQ1R12-M	ø3	1/8"	12	2	10	4	8	—	18.5	15.5	11.5
LQ1R21-M	ø6	1/8"	12	2	10	4	8	—	18.5	15.5	11.5
LQ1R22-M	ø4	1/8"	12	2	10	4	8	—	18.5	15.5	11.5
LQ1R2C-M	ø3	1/8"	12	2	10	4	8	—	18.5	15.5	11.5
LQ1R23-M	ø6	1/8"	12	2	10	4	8	—	18.5	15.5	11.5
LQ1R24-M	ø4	1/4"	12	2	10	4	8	—	18.5	15.5	11.5
LQ1R2F-M	ø3	1/4"	12	2	10	4	8	—	18.5	15.5	11.5
LQ1R31-M	ø10	1/4"	19	5	20	9	18	17	36.5	27	23
LQ1R32-M	ø8	1/4"	19	5	20	9	18	17	36.5	27	23
LQ1R33-M	ø6	1/4"	19	5	20	9	18	17	36.5	27	23
LQ1R34-M	ø10	3/8"	21	5	20	9	18	17	36.5	27	23
LQ1R35-M	ø8	3/8"	21	5	20	9	18	17	36.5	27	23
LQ1R36-M	ø6	3/8"	21	5	20	9	18	17	36.5	27	23
* LQ1R39-M	ø10	1/8"	17	—	—	—	—	—	34.5	20.5	—
* LQ1R310-M	ø8	1/8"	17	—	—	—	—	—	34.5	20.5	—
LQ1R41-M	ø12	3/8"	23	6	24	9	18	21	43	32	28
LQ1R42-M	ø10	3/8"	23	6	24	9	18	21	43	32	28
LQ1R43-M	ø12	1/2"	24.5	7	29	14	28	26	54	33.5	39
LQ1R44-M	ø10	1/2"	24.5	7	29	14	28	26	54	33.5	39
LQ1R49-M	ø12	1/4"	27.5	7	29	14	28	26	54	33.5	39
LQ1R51-M	ø19	1/2"	30.5	7	29	14	28	26	54	33.5	39
LQ1R52-M	ø12	1/2"	30.5	7	29	14	28	26	54	33.5	39
LQ1R53-M	ø19	3/4"	30	7	29	14	28	26	54	33.5	39
LQ1R54-M	ø12	3/4"	30	7	29	14	28	26	54	33.5	39
LQ1R58-M	ø19	1/4"	27.5	7	29	14	28	26	54	33.5	39
LQ1R59-M	ø19	3/8"	29	7	29	14	28	26	54	33.5	39
LQ1R61-M	ø25	3/4"	36	8	39.5	18	36	36	69.5	45	49
LQ1R62-M	ø19	3/4"	36	8	39.5	18	36	36	69.5	45	49
LQ1R63-M	ø25	1"	35	8	39.5	18	36	36	69.5	45	49
LQ1R64-M	ø19	1"	35	8	39.5	18	36	36	69.5	45	49

Note) Products marked "*" are produced upon receipt of order.

Inch sizes

Model	Applicable tubing O.D.	Connection threads R/NPT	A	B	E	F	G	H	L ₁	L ₂	M
LQ1R1A-M	1/8"	1/8"	12	2	10	4	8	—	18.5	15.5	11.5
LQ1R2A-M	1/4"	1/8"	12	2	10	4	8	—	18.5	15.5	11.5
LQ1R2B-M	3/16"	1/8"	12	2	10	4	8	—	18.5	15.5	11.5
LQ1R2C-M	1/8"	1/8"	12	2	10	4	8	—	18.5	15.5	11.5
LQ1R2D-M	1/4"	1/8"	12	2	10	4	8	—	18.5	15.5	11.5
LQ1R2E-M	3/16"	1/4"	12	2	10	4	8	—	18.5	15.5	11.5
LQ1R2F-M	1/8"	1/4"	12	2	10	4	8	—	18.5	15.5	11.5
LQ1R3A-M	3/8"	1/4"	19	5	20	9	18	17	36.5	27	23
LQ1R3B-M	1/4"	1/4"	19	5	20	9	18	17	36.5	27	23
LQ1R3C-M	3/8"	3/8"	21	5	20	9	18	17	36.5	27	23
LQ1R3D-M	1/4"	3/8"	21	5	20	9	18	17	36.5	27	23
* LQ1R3F-M	3/8"	1/8"	17	—	—	—	—	—	34.5	20.5	—
LQ1R4A-M	1/2"	3/8"	23	6	24	9	18	21	43	32	28
LQ1R4B-M	3/8"	3/8"	23	6	24	9	18	21	43	32	28
LQ1R4C-M	1/2"	1/2"	24.5	7	29	14	28	26	54	33.5	39
LQ1R4D-M	3/8"	1/2"	24.5	7	29	14	28	26	54	33.5	39
LQ1R4G-M	1/2"	1/4"	27.5	7	29	14	28	26	54	33.5	39
LQ1R5A-M	3/4"	1/2"	30.5	7	29	14	28	26	54	33.5	39
LQ1R5B-M	1/2"	1/2"	30.5	7	29	14	28	26	54	33.5	39
LQ1R5C-M	3/4"	3/4"	30	7	29	14	28	26	54	33.5	39
LQ1R5D-M	1/2"	3/4"	30	7	29	14	28	26	54	33.5	39
LQ1R5G-M	3/4"	1/4"	27.5	7	29	14	28	26	54	33.5	39
LQ1R5H-M	3/4"	3/8"	29	7	29	14	28	26	54	33.5	39
LQ1R6A-M	1"	3/4"	36	8	39.5	18	36	36	69.5	45	49
LQ1R6B-M	3/4"	3/4"	36	8	39.5	18	36	36	69.5	45	49
LQ1R6C-M	1"	1"	35	8	39.5	18	36	36	69.5	45	49
LQ1R6D-M	3/4"	3/4"	35	8	39.5	18	36	36	69.5	45	49

Note) Products marked "*" are produced upon receipt of order.

LQ1

LQ3

LVN

LQHB

TL/TIL

TD/TID

TH/THH

Applicable Fluid

Precautions

Series LQ1

Dimensions

Female Run Tee: LQ1R-F

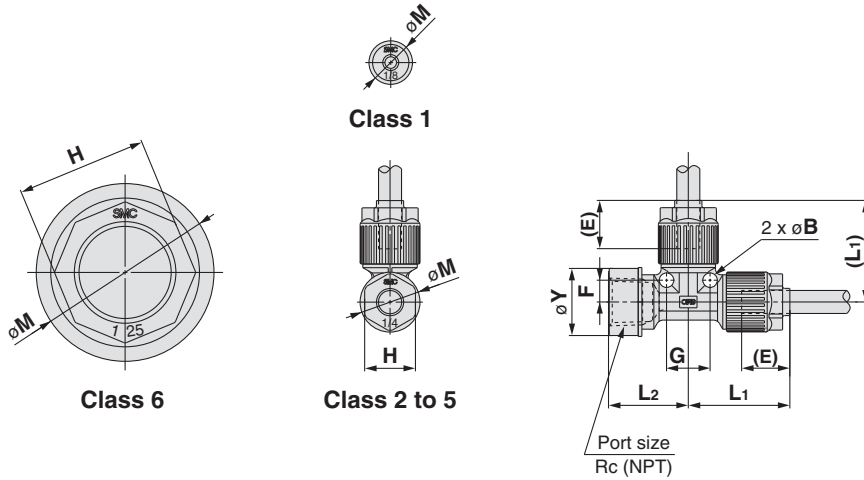

(E) shows the approximate dimension of the inserted tubing from the end of the nut.

Metric sizes

Model	Applicable tubing O.D.	Connection threads Rc/NPT	B	E	F	G	H	L ₁	L ₂	M	Y
LQ1R11-F□	ø4	1/8"	2	10	4	8	—	18.5	16	11.5	18.5
LQ1R12-F□	ø3	1/8"	2	10	4	8	—	18.5	16	11.5	18.5
LQ1R21-F□	ø6	1/8"	4	15	6	12	14	28	19.5	16.5	18.5
LQ1R22-F□	ø4	1/8"	4	15	6	12	14	28	19.5	16.5	18.5
LQ1R2C-F□	ø3	1/8"	4	15	6	12	14	28	19.5	16.5	18.5
LQ1R23-F□	ø6	1/4"	4	15	6	12	14	28	19.5	16.5	18.5
LQ1R24-F□	ø4	1/4"	4	15	6	12	14	28	19.5	16.5	18.5
LQ1R2F-F□	ø3	1/4"	4	15	6	12	14	28	19.5	16.5	18.5
LQ1R31-F□	ø10	1/4"	5	20	9	18	17	36.5	24	23	25
LQ1R32-F□	ø8	1/4"	5	20	9	18	17	36.5	24	23	25
LQ1R33-F□	ø6	1/4"	5	20	9	18	17	36.5	24	23	25
LQ1R34-F□	ø10	3/8"	5	20	9	18	17	36.5	24	23	25
LQ1R35-F□	ø8	3/8"	5	20	9	18	17	36.5	24	23	25
LQ1R36-F□	ø6	3/8"	5	20	9	18	17	36.5	24	23	25
* LQ1R39-F□	ø10	1/8"	—	—	—	—	—	34.5	19.7	—	18.5
* LQ1R310-F□	ø8	1/8"	—	—	—	—	—	34.5	19.7	—	18.5
LQ1R41-F□	ø12	3/8"	6	24	9	18	21	43	25	28	29.5
LQ1R42-F□	ø10	3/8"	6	24	9	18	21	43	25	28	29.5
LQ1R43-F□	ø12	1/2"	6	24	9	18	21	43	25	28	29.5
LQ1R44-F□	ø10	1/2"	6	24	9	18	21	43	25	28	29.5
* LQ1R49-F□	ø12	1/4"	—	—	—	—	—	41.5	21.2	—	21.5
LQ1R51-F□	ø19	1/2"	7	29	14	28	26	54	35.5	39	36
LQ1R52-F□	ø12	1/2"	7	29	14	28	26	54	35.5	39	36
LQ1R53-F□	ø19	3/4"	7	29	14	28	26	54	35.5	39	36
LQ1R54-F□	ø12	3/4"	7	29	14	28	26	54	35.5	39	36
LQ1R59-F□	ø19	3/8"	7	29	14	28	26	54	35.5	39	36
LQ1R61-F□	ø25	3/4"	8	39.5	18	36	36	69.5	46	49	44.5
LQ1R62-F□	ø19	3/4"	8	39.5	18	36	36	69.5	46	49	44.5
LQ1R63-F□	ø25	1"	8	39.5	18	36	36	69.5	46	49	44.5
LQ1R64-F□	ø19	1"	8	39.5	18	36	36	69.5	46	49	44.5
LQ1R66-F□	ø25	1/2"	8	39.5	18	36	36	69.5	46	49	44.5

Note) Products marked "*" are produced upon receipt of order.

Inch sizes

Model	Applicable tubing O.D.	Connection threads Rc/NPT	B	E	F	G	H	L ₁	L ₂	M	Y
LQ1R1A-F□	1/8"	1/8"	2	10	4	8	—	18.5	16	11.5	18.5
LQ1R2A-F□	1/4"	1/8"	4	15	6	12	14	28	19.5	16.5	18.5
LQ1R2B-F□	3/16"	1/8"	4	15	6	12	14	28	19.5	16.5	18.5
LQ1R2C-F□	1/8"	1/8"	4	15	6	12	14	28	19.5	16.5	18.5
LQ1R2D-F□	1/4"	1/4"	4	15	6	12	14	28	19.5	16.5	18.5
LQ1R2E-F□	3/16"	1/4"	4	15	6	12	14	28	19.5	16.5	18.5
LQ1R2F-F□	1/8"	1/4"	4	15	6	12	14	28	19.5	16.5	18.5
LQ1R3A-F□	3/8"	1/4"	5	20	9	18	17	36.5	24	23	25
LQ1R3B-F□	1/4"	1/4"	5	20	9	18	17	36.5	24	23	25
LQ1R3C-F□	3/8"	3/8"	5	20	9	18	17	36.5	24	23	25
LQ1R3D-F□	1/4"	3/8"	5	20	9	18	17	36.5	24	23	25
* LQ1R3F-F□	3/8"	1/8"	—	—	—	—	—	34.5	19.7	—	18.5
LQ1R4A-F□	1/2"	3/8"	6	24	9	18	21	43	25	28	29.5
LQ1R4B-F□	3/8"	3/8"	6	24	9	18	21	43	25	28	29.5
LQ1R4C-F□	1/2"	1/2"	6	24	9	18	21	43	25	28	29.5
LQ1R4D-F□	3/8"	1/2"	6	24	9	18	21	43	25	28	29.5
* LQ1R4G-F□	1/2"	1/4"	—	—	—	—	—	41.5	21.2	—	21.5
LQ1R5A-F□	3/4"	1/2"	7	29	14	28	26	54	35.5	39	36
LQ1R5B-F□	1/2"	1/2"	7	29	14	28	26	54	35.5	39	36
LQ1R5C-F□	3/4"	3/4"	7	29	14	28	26	54	35.5	39	36
LQ1R5D-F□	1/2"	3/4"	7	29	14	28	26	54	35.5	39	36
LQ1R5H-F□	3/4"	3/8"	7	29	14	28	26	54	35.5	39	36
LQ1R6A-F□	1"	3/4"	8	39.5	18	36	36	69.5	46	49	44.5
LQ1R6B-F□	3/4"	3/4"	8	39.5	18	36	36	69.5	46	49	44.5
LQ1R6C-F□	1"	1"	8	39.5	18	36	36	69.5	46	49	44.5
LQ1R6D-F□	3/4"	1"	8	39.5	18	36	36	69.5	46	49	44.5

Note) Products marked "*" are produced upon receipt of order.

Male Branch Tee: LQ1B-M

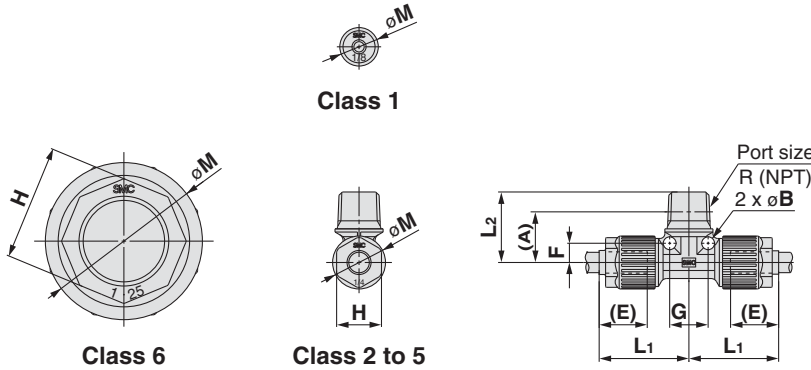

(A) shows the reference dimension after connection.
(E) shows the approximate dimension of the inserted tubing from the end of the nut.

Metric sizes

Model	Applicable tubing O.D.	Connection threads R/NPT	A	B	E	F	G	H	L ₁	L ₂	M
LQ1B11-M□	ø4	1/8"	12	2	10	4	8	—	18.5	15.5	11.5
LQ1B12-M□	ø3	1/8"	12	2	10	4	8	—	18.5	15.5	11.5
LQ1B21-M□	ø6	1/8"	16	4	15	6	12	14	28	19.5	16.5
LQ1B22-M□	ø4	1/8"	16	4	15	6	12	14	28	19.5	16.5
LQ1B2C-M□	ø3	1/8"	16	4	15	6	12	14	28	19.5	16.5
LQ1B23-M□	ø6	1/4"	19	5	20	9	18	17	36.5	25	23
LQ1B24-M□	ø4	1/4"	19	5	20	9	18	17	36.5	25	23
LQ1B2F-M□	ø3	1/4"	19	5	20	9	18	17	36.5	25	23
LQ1B31-M□	ø10	3/8"	21	5	20	9	18	17	36.5	27	23
LQ1B32-M□	ø8	3/8"	21	5	20	9	18	17	36.5	27	23
LQ1B33-M□	ø6	3/8"	21	5	20	9	18	17	36.5	27	23
LQ1B34-M□	ø10	3/8"	21	5	20	9	18	17	36.5	27	23
LQ1B35-M□	ø8	3/8"	21	5	20	9	18	17	36.5	27	23
LQ1B36-M□	ø6	3/8"	21	5	20	9	18	17	36.5	27	23
* LQ1B39-M□	ø10	1/8"	18.4	—	—	—	—	—	29	21.9	—
* LQ1B310-M□	ø8	1/8"	18.4	—	—	—	—	—	29	21.9	—
LQ1B41-M□	ø12	3/8"	23	6	24	9	18	21	43	29	28
LQ1B42-M□	ø10	3/8"	23	6	24	9	18	21	43	29	28
LQ1B43-M□	ø12	1/2"	24.5	7	29	14	28	26	54	39	39
LQ1B44-M□	ø10	1/2"	24.5	7	29	14	28	26	54	39	39
* LQ1B45-M□	ø8	1/2"	21.5	—	20	—	—	17	34	29.5	23
LQ1B49-M□	ø12	1/4"	27.5	7	29	14	28	26	54	33.5	39
LQ1B51-M□	ø19	1/2"	30.5	8	39.5	18	36	36	69.5	45	49
LQ1B52-M□	ø12	1/2"	30.5	7	29	14	28	26	54	39	39
LQ1B53-M□	ø19	3/4"	30	7	29	14	28	26	54	39	39
LQ1B54-M□	ø12	3/4"	30	7	29	14	28	26	54	39	39
LQ1B58-M□	ø19	1/4"	27.5	7	29	14	28	26	54	33.5	39
LQ1B59-M□	ø19	3/8"	29	7	29	14	28	26	54	35	39
LQ1B61-M□	ø25	3/4"	36	8	39.5	18	36	36	69.5	45	49
LQ1B62-M□	ø19	3/4"	36	8	39.5	18	36	36	69.5	45	49
LQ1B63-M□	ø25	1"	35	8	39.5	18	36	36	69.5	45	49
LQ1B64-M□	ø19	1"	35	8	39.5	18	36	36	69.5	45	49
LQ1B66-M□	ø25	1/2"	37	8	39.5	18	36	36	69.5	45	49

Note) Products marked "*" are produced upon receipt of order.

Inch sizes

Model	Applicable tubing O.D.	Connection threads R/NPT	A	B	E	F	G	H	L ₁	L ₂	M
LQ1B1A-M□	1/8"	1/8"	12	2	10	4	8	—	18.5	15.5	11.5
LQ1B2A-M□	1/4"	1/8"	16	4	15	6	12	14	28	19.5	16.5
LQ1B2B-M□	3/16"	1/8"	16	4	15	6	12	14	28	19.5	16.5
LQ1B2C-M□	1/8"	1/8"	16	4	15	6	12	14	28	19.5	16.5
LQ1B2D-M□	1/4"	1/4"	19	5	20	9	18	17	36.5	25	23
LQ1B2E-M□	3/16"	1/4"	19	5	20	9	18	17	36.5	25	23
LQ1B2F-M□	1/8"	1/4"	19	5	20	9	18	17	36.5	25	23
LQ1B3A-M□	3/8"	3/8"	21	5	20	9	18	17	36.5	27	23
LQ1B3B-M□	1/4"	3/8"	21	5	20	9	18	17	36.5	27	23
LQ1B3C-M□	3/8"	3/8"	21	5	20	9	18	17	36.5	27	23
LQ1B3D-M□	1/4"	3/8"	21	5	20	9	18	17	36.5	27	23
* LQ1B3F-M□	3/8"	1/8"	18.4	—	—	—	—	—	29	21.9	—
LQ1B4A-M□	1/2"	3/8"	23	6	24	9	18	21	43	29	28
LQ1B4B-M□	3/8"	3/8"	23	6	24	9	18	21	43	29	28
LQ1B4C-M□	1/2"	1/2"	24.5	7	29	14	28	26	54	33.5	39
LQ1B4D-M□	3/8"	1/2"	24.5	7	29	14	28	26	54	33.5	39
LQ1B4G-M□	1/2"	1/4"	27.5	7	29	14	28	26	54	33.5	39
LQ1B5A-M□	3/4"	3/4"	30	7	29	14	28	26	54	39	39
LQ1B5B-M□	1/2"	1/2"	30.5	7	29	14	28	26	54	39	39
LQ1B5C-M□	3/4"	3/4"	30	7	29	14	28	26	54	39	39
LQ1B5D-M□	1/2"	3/4"	30	7	29	14	28	26	54	39	39
LQ1B5G-M□	3/4"	1/4"	27.5	7	29	14	28	26	54	33.5	39
LQ1B5H-M□	3/4"	3/8"	29	7	29	14	28	26	54	35	39
LQ1B6A-M□	1"	3/4"	36	8	39.5	18	36	36	69.5	45	49
LQ1B6B-M□	3/4"	3/4"	36	8	39.5	18	36	36	69.5	45	49
LQ1B6C-M□	1"	1"	35	8	39.5	18	36	36	69.5	45	49
LQ1B6D-M□	3/4"	3/4"	35	8	39.5	18	36	36	69.5	45	49
LQ1B6F-M□	1"	1/2"	37	8	39.5	18	36	36	69.5	45	49

Note) Products marked "*" are produced upon receipt of order.

Series LQ1

Dimensions

Female Branch Tee: LQ1B-F



Class 1

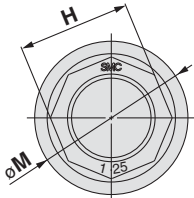

Class 6

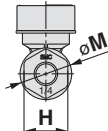

Class 2 to 5

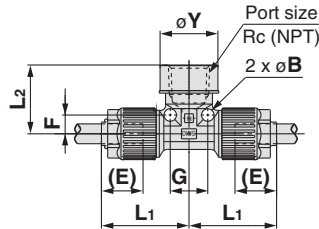

(E) shows the approximate dimension of the inserted tubing from the end of the nut.

Metric sizes

Model	Applicable tubing O.D.	Connection threads Rc/NPT	B	E	F	G	H	L ₁	L ₂	M	Y
LQ1B11-F□	ø4	1/8"	2	10	4	8	—	18.5	16	11.5	18.5
LQ1B12-F□	ø3	1/8"	2	10	4	8	—	18.5	16	11.5	18.5
LQ1B21-F□	ø6	1/8"	4	15	6	12	14	28	19.5	16.5	18.5
LQ1B22-F□	ø4	1/8"	4	15	6	12	14	28	19.5	16.5	18.5
LQ1B2C-F□	ø3	1/8"	4	15	6	12	14	28	19.5	16.5	18.5
LQ1B23-F□	ø6	1/4"	4	15	6	12	14	28	19.5	16.5	18.5
LQ1B24-F□	ø4	1/4"	4	15	6	12	14	28	19.5	16.5	18.5
LQ1B2F-F□	ø3	1/4"	4	15	6	12	14	28	19.5	16.5	18.5
LQ1B31-F□	ø10	1/4"	5	20	9	18	17	36.5	23	23	25
LQ1B32-F□	ø8	1/4"	5	20	9	18	17	36.5	23	23	25
LQ1B33-F□	ø6	3/8"	5	20	9	18	17	36.5	23	23	25
LQ1B34-F□	ø10	3/8"	5	20	9	18	17	36.5	23	23	25
LQ1B35-F□	ø8	3/8"	5	20	9	18	17	36.5	23	23	25
LQ1B36-F□	ø6	3/8"	5	20	9	18	17	36.5	23	23	25
* LQ1B39-F□	ø10	1/8"	—	—	—	—	—	32.3	18.7	—	18.5
* LQ1B310-F□	ø8	1/8"	—	—	—	—	—	32.3	18.7	—	18.5
LQ1B41-F□	ø12	3/8"	6	24	9	18	21	43	25	28	25
LQ1B42-F□	ø10	3/8"	6	24	9	18	21	43	25	28	25
LQ1B43-F□	ø12	1/2"	6	24	9	18	21	43	25	28	25
LQ1B44-F□	ø10	1/2"	6	24	9	18	21	43	25	28	25
* LQ1B49-F□	ø12	1/4"	7	29	14	28	26	44.3	27.5	39	21.5
LQ1B51-F□	ø19	1/2"	7	29	14	28	26	44.3	27.5	39	21.5
LQ1B52-F□	ø12	1/2"	7	29	14	28	26	44.3	27.5	39	21.5
LQ1B53-F□	ø19	3/4"	7	29	14	28	26	44.3	27.5	39	21.5
LQ1B54-F□	ø12	3/4"	7	29	14	28	26	44.3	27.5	39	21.5
* LQ1B58-F□	ø19	1/4"	—	—	—	—	—	46	29.5	—	25
* LQ1B59-F□	ø19	3/8"	—	—	—	—	—	46	29.5	—	25
LQ1B61-F□	ø25	3/4"	8	39.5	18	36	36	69.5	46	49	44.5
LQ1B62-F□	ø19	3/4"	8	39.5	18	36	36	69.5	46	49	44.5
LQ1B63-F□	ø25	1"	8	39.5	18	36	36	69.5	46	49	44.5
LQ1B64-F□	ø19	1"	8	39.5	18	36	36	69.5	46	49	44.5
LQ1B66-F□	ø25	1/2"	8	39.5	18	36	36	69.5	46	49	44.5

Note) Products marked "*" are produced upon receipt of order.

Inch sizes

Model	Applicable tubing O.D.	Connection threads Rc/NPT	B	E	F	G	H	L ₁	L ₂	M	Y
LQ1B1A-F□	1/8"	1/8"	2	10	4	8	—	18.5	16	11.5	18.5
LQ1B2A-F□	1/4"	1/8"	4	15	6	12	14	28	19.5	16.5	18.5
LQ1B2B-F□	3/16"	1/8"	4	15	6	12	14	28	19.5	16.5	18.5
LQ1B2C-F□	1/8"	1/8"	4	15	6	12	14	28	19.5	16.5	18.5
LQ1B2D-F□	1/4"	1/4"	4	15	6	12	14	28	19.5	16.5	18.5
LQ1B2E-F□	3/16"	1/4"	4	15	6	12	14	28	19.5	16.5	18.5
LQ1B2F-F□	1/8"	1/4"	4	15	6	12	14	28	19.5	16.5	18.5
LQ1B3A-F□	3/8"	1/4"	5	20	9	18	17	36.5	23	23	25
LQ1B3B-F□	1/4"	1/4"	5	20	9	18	17	36.5	23	23	25
LQ1B3C-F□	3/8"	3/8"	5	20	9	18	17	36.5	23	23	25
LQ1B3D-F□	1/4"	3/8"	5	20	9	18	17	36.5	23	23	25
* LQ1B3F-F□	3/8"	1/8"	—	—	—	—	—	32.3	18.7	—	18.5
LQ1B4A-F□	1/2"	3/8"	6	24	9	18	21	43	25	28	25
LQ1B4B-F□	3/8"	3/8"	6	24	9	18	21	43	25	28	25
LQ1B4C-F□	1/2"	1/2"	6	24	9	18	21	43	25	28	25
LQ1B4D-F□	3/8"	1/2"	6	24	9	18	21	43	25	28	25
* LQ1B4G-F□	1/2"	1/4"	—	29	—	—	26	44.3	27.5	39	21.5
LQ1B5A-F□	3/4"	1/2"	7	29	14	28	26	44.3	27.5	39	21.5
LQ1B5B-F□	1/2"	1/2"	7	29	14	28	26	44.3	27.5	39	21.5
LQ1B5C-F□	3/4"	3/4"	7	29	14	28	26	44.3	27.5	39	21.5
LQ1B5D-F□	1/2"	3/4"	7	29	14	28	26	44.3	27.5	39	21.5
* LQ1B5G-F□	3/4"	1/4"	—	—	—	—	—	46	29.5	—	25
* LQ1B5H-F□	3/4"	3/8"	—	—	—	—	—	46	29.5	—	25
LQ1B6A-F□	1"	3/4"	8	39.5	18	36	36	69.5	46	49	44.5
LQ1B6B-F□	3/4"	3/4"	8	39.5	18	36	36	69.5	46	49	44.5
LQ1B6C-F□	1"	1"	8	39.5	18	36	36	69.5	46	49	44.5
LQ1B6D-F□	3/4"	3/4"	8	39.5	18	36	36	69.5	46	49	44.5
LQ1B6F-F□	1"	1/2"	8	39.5	18	36	36	69.5	46	49	44.5

Note) Products marked "*" are produced upon receipt of order.

Union Elbow: LQ1E



Class 1

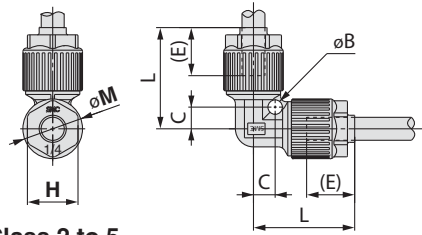

Class 2 to 5

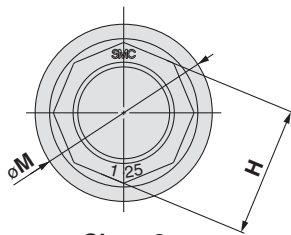

Class 6

(E) shows the approximate dimension of the inserted tubing from the end of the nut.

Metric sizes

Model	Applicable tubing O.D.	B	C	E	H	L	M
LQ1E11	$\phi 4$	2	4	10	—	18.5	11.5
LQ1E12	$\phi 3$						
LQ1E21□□	$\phi 6$	4	6	15	14	28	16.5
LQ1E22□□	$\phi 4$						
LQ1E2C□□	$\phi 3$						
LQ1E31□□	$\phi 10$	5	9	20	17	36.5	23
LQ1E32□□	$\phi 8$						
LQ1E33□□	$\phi 6$						
LQ1E41□□	$\phi 12$	6	9	24	21	43	28
LQ1E42□□	$\phi 10$						
LQ1E51□□	$\phi 19$	7	14	29	26	54	39
LQ1E52□□	$\phi 12$						
LQ1E61□□	$\phi 25$	8	18	39.5	36	69.5	49
LQ1E62□□	$\phi 19$						

Inch sizes

Model	Applicable tubing O.D.	B	C	E	H	L	M
LQ1E1A	1/8"	2	4	10	—	18.5	11.5
LQ1E2A□□	1/4"						
LQ1E2B□□	3/16"	4	6	15	14	28	16.5
LQ1E2C□□	1/8"						
LQ1E3A□□	3/8"						
LQ1E3B□□	1/4"	5	9	20	17	36.5	23
LQ1E4A□□	1/2"						
LQ1E4B□□	3/8"	6	9	24	21	43	28
LQ1E5A□□	3/4"						
LQ1E5B□□	1/2"	7	14	29	26	54	39
LQ1E6A□□	1"						
LQ1E6B□□	3/4"	8	18	39.5	36	69.5	49
LQ1E6B□□	3/4"						

LQ1

LQ3

LVN

LQHB

TL/TIL

TD/TID

TH/THH

Applicable Fluid

Precautions

Series LQ1

Dimensions

Union Tee: LQ1T



Class 1

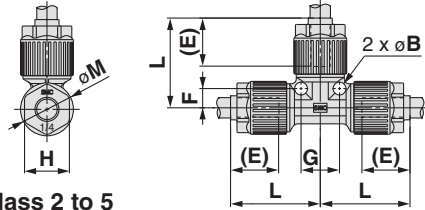

Class 2 to 5

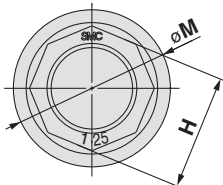

Class 6

(E) shows the approximate dimension of the inserted tubing from the end of the nut.

Metric sizes

Model	Applicable tubing O.D.	B	E	F	G	H	L	M
LQ1T11	φ4	2	10	4	8	—	18.5	11.5
LQ1T12	φ3							
LQ1T21□□	φ6	4	15	6	12	14	28	16.5
LQ1T22□□	φ4							
LQ1T2C□□	φ3							
LQ1T31□□	φ10	5	20	9	18	17	36.5	23
LQ1T32□□	φ8							
LQ1T33□□	φ6							
LQ1T41□□	φ12	6	24	9	18	21	43	28
LQ1T42□□	φ10							
LQ1T51□□	φ19	7	29	14	28	26	54	39
LQ1T52□□	φ12							
LQ1T61□□	φ25	8	39.5	18	36	36	69.5	49
LQ1T62□□	φ19							

Inch sizes

Model	Applicable tubing O.D.	B	E	F	G	H	L	M
LQ1T1A	1/8"	2	10	4	8	—	18.5	11.5
LQ1T2A□□	1/4"							
LQ1T2B□□	3/16"	4	15	6	12	14	28	16.5
LQ1T2C□□	1/8"							
LQ1T3A□□	3/8"							
LQ1T3B□□	1/4"	5	20	9	18	17	36.5	23
LQ1T4A□□	1/2"							
LQ1T4B□□	3/8"	6	24	9	18	21	43	28
LQ1T5A□□	3/4"							
LQ1T5B□□	1/2"	7	29	14	28	26	54	39
LQ1T6A□□	1"							
LQ1T6B□□	3/4"	8	39.5	18	36	36	69.5	49
LQ1T6B□□	3/4"							

Panel Mount Union: LQ1P



Class 1

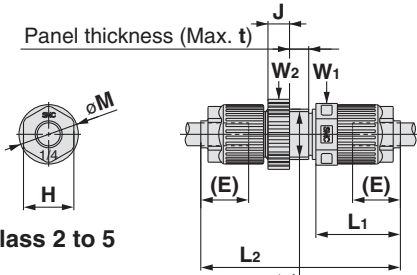

Class 2 to 5

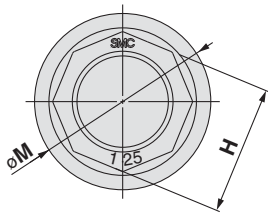

Class 6

(E) shows the approximate dimension of the inserted tubing from the end of the nut.
 "W" is width across flats dimension.

Metric sizes

Model	Applicable tubing O.D.	E	H	J	K	L ₁	L ₂	M	t	W ₁	W ₂
LQ1P11	ø4	10	—	6	10.5	17	44	11.5	8	11	13
LQ1P12	ø3										
LQ1P21□□	ø6	15	14	6	14.5	23.5	55.5	16.5	8	15	17
LQ1P22□□	ø4										
LQ1P2C□□	ø3										
LQ1P31□□	ø10	20	17	7	20.5	30	69	23	8	21	24
LQ1P32□□	ø8										
LQ1P33□□	ø6										
LQ1P41□□	ø12	24	21	7	24.5	35	78.5	28	8	26	28
LQ1P42□□	ø10										
LQ1P51□□	ø19	29	26	9	36.5	43.5	100	39	9	39	43
LQ1P52□□	ø12										
LQ1P61□□	ø25	39.5	36	10	48.5	58.5	133	49	10	51	55
LQ1P62□□	ø19										

Inch sizes

Model	Applicable tubing O.D.	E	H	J	K	L ₁	L ₂	M	t	W ₁	W ₂
LQ1P1A	1/8"	10	—	6	10.5	17	44	11.5	8	11	13
LQ1P2A□□	1/4"										
LQ1P2B□□	3/16"	15	14	6	14.5	23.5	55.5	16.5	8	15	17
LQ1P2C□□	1/8"										
LQ1P3A□□	3/8"										
LQ1P3B□□	1/4"	20	17	7	20.5	30	69	23	8	21	24
LQ1P4A□□	1/2"										
LQ1P4B□□	3/8"										
LQ1P5A□□	3/4"	29	26	9	36.5	43.5	100	39	9	39	43
LQ1P5B□□	1/2"										
LQ1P6A□□	1"	39.5	36	10	48.5	58.5	133	49	10	51	55
LQ1P6B□□	3/4"										

LQ1

LQ3

LVN

LQHB

TL/TIL

TD/TID

TH/TIH

Applicable Fluid

Precautions

Series LQ1

Dimensions

Union: LQ1U



Class 1

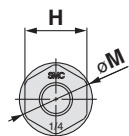

Class 2 to 5

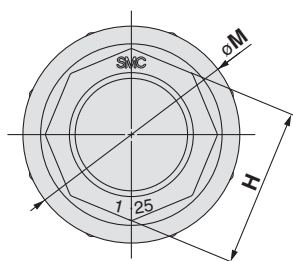
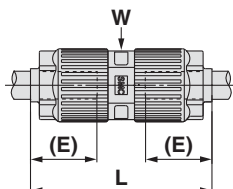

Class 6

(E) shows the approximate dimension of the inserted tubing from the end of the nut.
“W” is width across flats dimension.

Metric sizes

Model	Applicable tubing O.D.	E	H	L	M	W
LQ1U11	$\phi 4$	10	—	29	11.5	10
LQ1U12	$\phi 3$					
LQ1U21□□	$\phi 6$	15	14	41	16.5	14
LQ1U22□□	$\phi 4$					
LQ1U2C□□	$\phi 3$					
LQ1U31□□	$\phi 10$	20	17	54	23	19
LQ1U32□□	$\phi 8$					
LQ1U33□□	$\phi 6$					
LQ1U41□□	$\phi 12$	24	21	63	28	23
LQ1U42□□	$\phi 10$					
LQ1U51□□	$\phi 19$	29	26	77	39	32
LQ1U52□□	$\phi 12$					
LQ1U61□□	$\phi 25$	39.5	36	102	49	46
LQ1U62□□	$\phi 19$					

Inch sizes

Model	Applicable tubing O.D.	E	H	L	M	W
LQ1U1A	1/8"	10	—	29	11.5	10
LQ1U2A□□	1/4"					
LQ1U2B□□	3/16"	15	14	41	16.5	14
LQ1U2C□□	1/8"					
LQ1U3A□□	3/8"					
LQ1U3B□□	1/4"	20	17	54	23	19
LQ1U4A□□	1/2"					
LQ1U4B□□	3/8"	24	21	63	28	23
LQ1U5A□□	3/4"					
LQ1U5B□□	1/2"	29	26	77	39	32
LQ1U6A□□	1"					
LQ1U6B□□	3/4"	39.5	36	102	49	46

Union Flange: LQ1F

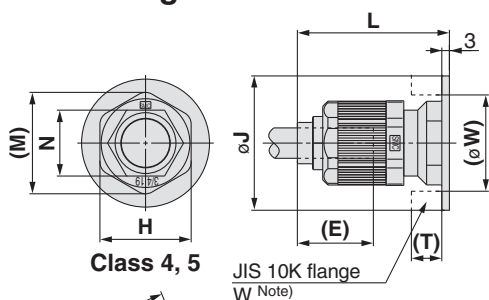

Class 4, 5

Class 6

Metric sizes

Model	Applicable tubing O.D.	E	H	J	L	N	M	W	(T)
LQ1F41	$\phi 12$	28	30	53	60	21	33.1	34	12
LQ1F42	$\phi 10$				58				
LQ1F51	$\phi 19$	32	36	58	65.2	26	40	41	14
LQ1F52	$\phi 12$				63.2				
LQ1F61	$\phi 25$	39.5	36	69	81.5	—	49	51	14
LQ1F62	$\phi 19$								

Inch sizes

Model	Applicable tubing O.D.	E	H	J	L	N	M	W	(T)
LQ1F4A	1/2"	28	30	53	60	21	33.1	34	12
LQ1F4B	3/8"				58				
LQ1F5A	3/4"	32	36	58	65.2	26	40	41	14
LQ1F5B	1/2"				63.2				
LQ1F6A	1"	39.5	36	69	81.5	—	49	51	14
LQ1F6B	3/4"								

(E) shows the approximate dimension of the inserted tubing from the end of the nut.
(W) is the bore size of the JIS flange required for mounting. This flange is sold separately.
When ordering nuts as spare parts, size 4 and 5 are as shown below.

LQ1F4□: LQ-4N□□

LQ1F5□: LQ-5N□□

Series LQ1

Union Elbow Reducing

How to Order

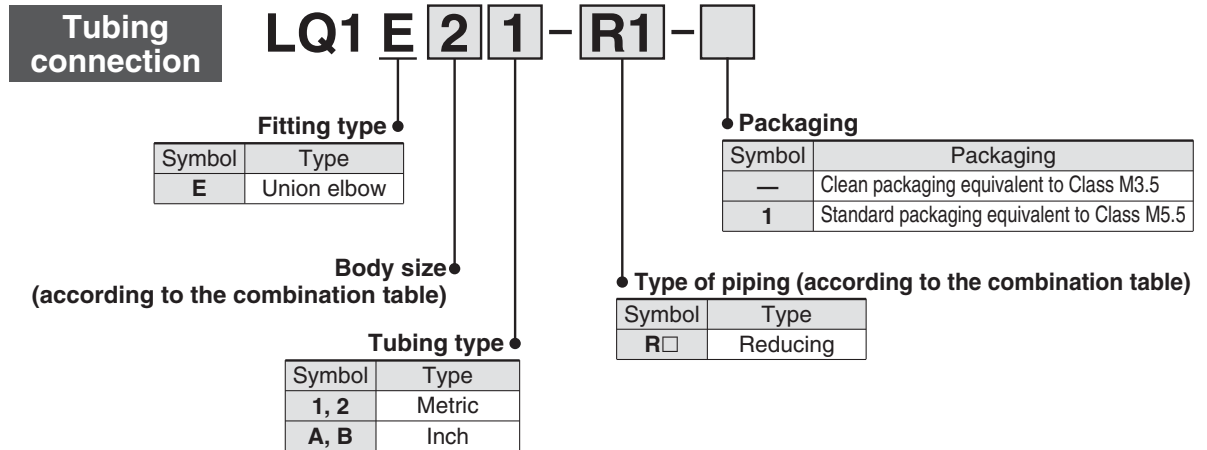

Size combination (Metric)

Class	Model	A side	B side
		Applicable tubing size (mm)	
2	LQ1E21-R1	6 x 4	4 x 3
	LQ1E21-R2		3 x 2
	LQ1E22-R1	4 x 3	3 x 2
3	LQ1E31-R1	10 x 8	8 x 6
	LQ1E31-R2		6 x 4
	LQ1E32-R1	8 x 6	6 x 4
4	LQ1E41-R1	12 x 10	10 x 8
	LQ1E41-R2		8 x 6
	* LQ1E41-R3		6 x 4
	* LQ1E41-R5		3 x 2
	LQ1E51-R1		12 x 10
5	* LQ1E51-R2	19 x 16	10 x 8
	* LQ1E51-R3		8 x 6
	* LQ1E51-R4		6 x 4
	* LQ1E51-R5		4 x 3
	LQ1E61-R1		19 x 16
6	* LQ1E61-R2	25 x 22	12 x 10
	* LQ1E61-R3		10 x 8
	* LQ1E61-R4		8 x 6
	* LQ1E61-R5		6 x 4
	LQ1E61-R1		19 x 16

Note 1) Products marked "*" are produced upon receipt of order.
 Note 2) For details of the applicable tubing sizes, refer to page 72.

Size combination (Inch)

Class	Model	A side	B side
		Applicable tubing size (inch)	
2	LQ1E2A-R1	1/4" x 5/32"	3/16" x 1/8"
	LQ1E2A-R2		1/8" x 0.086"
	LQ1E2B-R1	3/16" x 1/8"	1/8" x 0.086"
3	LQ1E3A-R1	3/8" x 1/4"	1/4" x 5/32"
	* LQ1E3A-R3		1/8" x 0.086"
	LQ1E4A-R1	3/8" x 1/4"	3/8" x 1/4"
4	LQ1E4A-R2	1/2" x 3/8"	1/4" x 5/32"
	* LQ1E4A-R3		3/16" x 0.127"
	* LQ1E4A-R4		1/8" x 0.086"
	LQ1E5A-R1		1/2" x 3/8"
5	* LQ1E5A-R2	3/4" x 5/8"	3/8" x 1/4"
	* LQ1E5A-R3		1/4" x 5/32"
	* LQ1E5A-R4		3/16" x 0.127"
	LQ1E6A-R1		3/4" x 5/8"
6	* LQ1E6A-R2	1" x 7/8"	1/2" x 3/8"
	* LQ1E6A-R3		3/8" x 1/4"
	* LQ1E6A-R4		1/4" x 5/32"
	* LQ1E6A-R5		3/16" x 0.127"

Note 1) Products marked "*" are produced upon receipt of order.
 Note 2) For details of the applicable tubing sizes, refer to page 72.

LQ1

LQ3

LVN

LQHB

TL/TIL

TD/TID

TH/THI

Applicable Fluid

Precautions

Series LQ1

Dimensions

Union Elbow Reducing: LQ1E-R

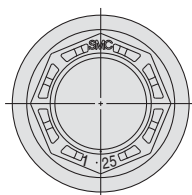
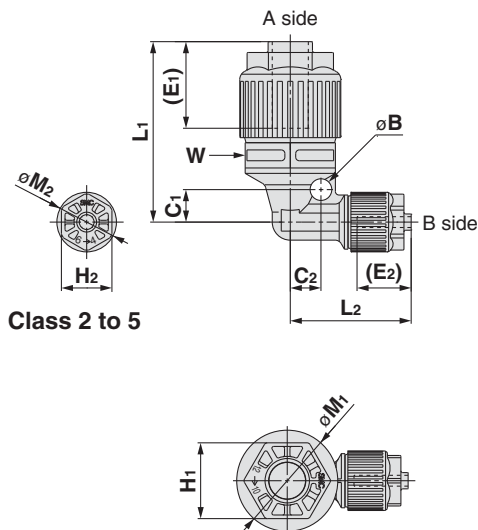

Class 6

Metric Size

Model	A side	B side	B	C ₁	C ₂	E ₁	E ₂	H ₁	H ₂	L ₁	L ₂	M ₁	M ₂	W	
	Applicable tubing O.D.														
LQ1E21-R1	ø6	ø4	4	6	6	15	15	14	14	28	28	16.5	16.5	—	
LQ1E21-R2	ø6	ø3													
LQ1E22-R1	ø4	ø3													
LQ1E31-R1	ø10	ø8	5	9	9	20	20	17	17	36.5	36.5	23	23	—	
LQ1E31-R2	ø10	ø6													
LQ1E32-R1	ø8	ø6													
LQ1E41-R1	ø12	ø10	6	9	9	24	24	21	21	43	43	28	28	—	
LQ1E41-R2	ø12	ø8					20		17						38.5
* LQ1E41-R3	ø12	ø6					15		14						
* LQ1E41-R5	ø12	ø3	—	—	—	15	14	35.5	31.5	28	16.5	25			
LQ1E51-R1	ø19	ø12	7	14	14	29	29	26	26	54	54	39	39	—	
* LQ1E51-R2	ø19	ø10	—	—	—	39.5	20	36	17	56.5	52.5	49	23	46	
* LQ1E51-R3	ø19	ø8								54	47.5				
* LQ1E51-R4	ø19	ø6								—	—				—
* LQ1E51-R5	ø19	ø4	—	—	—	39.5	15	36	14	51	42	39	16.5	32	
LQ1E61-R1	ø25	ø19	8	18	18	39.5	39.5	36	36	69.5	69.5	49	49	—	
* LQ1E61-R2	ø25	ø12	—	—	—		24		21	56.5	52.5				
* LQ1E61-R3	ø25	ø10	—	—	—		20		17	54	47.5				
* LQ1E61-R4	ø25	ø8	—	—	—	39.5	20	36	17	54	47.5	49	23	46	
* LQ1E61-R5	ø25	ø6	—	—	—	39.5	15	36	14	51	42	39	16.5	32	

Note) Products marked "*" are produced upon receipt of order.

Inch Size

Model	A side	B side	B	C ₁	C ₂	E ₁	E ₂	H ₁	H ₂	L ₁	L ₂	M ₁	M ₂	W	
	Applicable tubing O.D.														
LQ1E2A-R1	1/4"	3/16"	4	6	6	15	15	14	14	41	41	16.5	16.5	14	
LQ1E2A-R2	1/4"	1/8"													
LQ1E2B-R1	3/16"	1/8"													
LQ1E3A-R1	3/8"	1/4"	5	9	9	20	20	17	17	36.5	36.5	23	23	—	
* LQ1E3A-R3	3/8"	1/8"	—	—	—	24	15	21	14	35.5	31.5	28	16.5	—	
LQ1E4A-R1	1/2"	3/8"	6	9	9	24	24	21	21	43	43	28	28	—	
LQ1E4A-R2	1/2"	1/4"					20		17						38.5
* LQ1E4A-R3	1/2"	3/16"					15		14						
* LQ1E4A-R4	1/2"	1/8"	—	—	—	15	14	35.5	31.5	28	16.5	—			
LQ1E5A-R1	3/4"	1/2"	7	14	14	29	29	26	26	54	54	39	39	—	
* LQ1E5A-R2	3/4"	3/8"	—	—	—	39.5	20	36	17	54	47.5	49	23	46	
* LQ1E5A-R3	3/4"	1/4"													
* LQ1E5A-R4	3/4"	3/16"													15
LQ1E6A-R1	1"	3/4"	8	18	18	39.5	39.5	36	36	69.5	69.5	49	49	—	
* LQ1E6A-R2	1"	1/2"	—	—	—		24		21	56.5	52.5				
* LQ1E6A-R3	1"	3/8"	—	—	—		20		17	54	47.5				
* LQ1E6A-R4	1"	1/4"	—	—	—	39.5	20	36	17	54	47.5	49	23	46	
* LQ1E6A-R5	1"	3/16"	—	—	—	39.5	15	36	14	51	42	39	16.5	32	

Note) Products marked "*" are produced upon receipt of order.

Series LQ1 Union Tee Reducing

How to Order

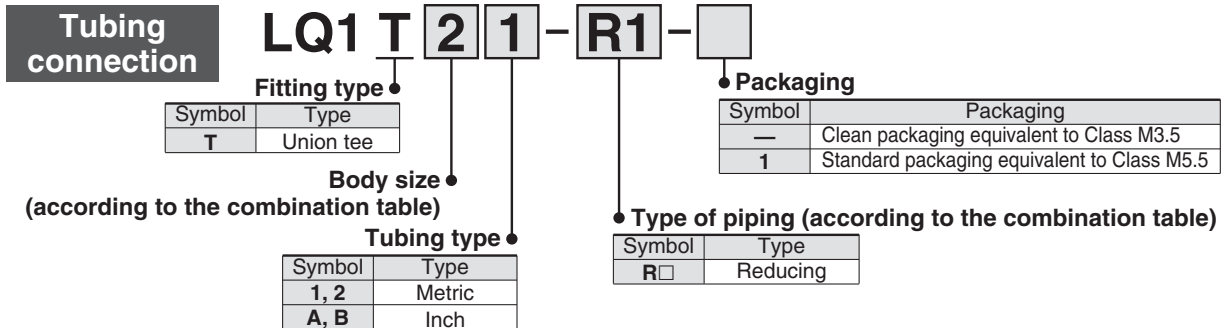

Size combination (Metric)

Class	Model	Applicable tubing size (mm)			
		A side	B side	C side	
2	LQ1T21-R1	6 x 4	4 x 3	6 x 4	
	LQ1T21-R2		3 x 2	6 x 4	
	LQ1T21-R9	4 x 3	6 x 4	4 x 3	
	LQ1T21-R10	3 x 2	6 x 4	3 x 2	
	LQ1T22-R1	4 x 3	3 x 2	4 x 3	
	LQ1T22-R9	3 x 2	4 x 3	3 x 2	
3	LQ1T31-R1	10 x 8	8 x 6	10 x 8	
	LQ1T31-R2		6 x 4	10 x 8	
	LQ1T31-R4	3 x 2	10 x 8		
	LQ1T31-R7	8 x 6	10 x 8		
	LQ1T31-R8	6 x 4	10 x 8		
	LQ1T31-R9	8 x 6	10 x 8		
	LQ1T31-R10	6 x 4	10 x 8		
	LQ1T32-R1	8 x 6	6 x 4	8 x 6	
	LQ1T32-R5	6 x 4	8 x 6	8 x 6	
	LQ1T32-R6		10 x 8	10 x 8	
LQ1T32-R7	6 x 4	8 x 6	6 x 4		
LQ1T32-R9	8 x 6	6 x 4	8 x 6		
4	LQ1T41-R1	12 x 10	10 x 8	12 x 10	
	LQ1T41-R2		8 x 6	12 x 10	
	LQ1T41-R3	6 x 4	12 x 10		
	LQ1T41-R5	12 x 10	12 x 10		
	LQ1T41-R7	10 x 8	12 x 10		
	LQ1T41-R9	12 x 10	10 x 8		
	LQ1T41-R11	6 x 4	10 x 8	12 x 10	
	LQ1T41-R12	12 x 10	12 x 10		
	LQ1T41-R22	10 x 8	6 x 4	12 x 10	
	LQ1T41-R23	6 x 4	6 x 4	12 x 10	
	LQ1T41-R26	12 x 10	3 x 2	12 x 10	
	LQ1T41-R32	6 x 4	12 x 10	6 x 4	
	LQ1T41-R34	3 x 2	12 x 10	3 x 2	
	5	LQ1T51-R1	19 x 16	12 x 10	19 x 16
LQ1T51-R2		10 x 8		19 x 16	
LQ1T51-R3		8 x 6		19 x 16	
LQ1T51-R4		6 x 4		19 x 16	
LQ1T51-R5		12 x 10	19 x 16	19 x 16	
LQ1T51-R6		10 x 8	19 x 16	19 x 16	
* LQ1T51-R7		12 x 10	12 x 10	19 x 16	
* LQ1T51-R8		10 x 8	10 x 8	19 x 16	
LQ1T51-R9		12 x 10	19 x 16	12 x 10	
LQ1T51-R10		10 x 8	19 x 16	10 x 8	
LQ1T51-R12		8 x 6	19 x 16	19 x 16	
LQ1T51-R13		6 x 4	19 x 16	19 x 16	
* LQ1T51-R17		10 x 8	12 x 10	19 x 16	
LQ1T51-R24		12 x 10	6 x 4	19 x 16	
LQ1T51-R26		19 x 16	4 x 3	19 x 16	
LQ1T51-R28			3 x 2	19 x 16	
LQ1T51-R31		10 x 8	19 x 16	12 x 10	
6		LQ1T61-R1	25 x 22	19 x 16	25 x 22
		LQ1T61-R2		12 x 10	25 x 22
		LQ1T61-R3		10 x 8	25 x 22
	* LQ1T61-R4	8 x 6		25 x 22	
	LQ1T61-R5	19 x 16	25 x 22	25 x 22	
	LQ1T61-R6	12 x 10	25 x 22	25 x 22	
	LQ1T61-R7	19 x 16	19 x 16	25 x 22	
	* LQ1T61-R8	12 x 10	12 x 10	25 x 22	
	LQ1T61-R9	19 x 16	25 x 22	19 x 16	
	LQ1T61-R10	12 x 10	25 x 22	12 x 10	
	LQ1T61-R11	12 x 10	19 x 16	25 x 22	
	* LQ1T61-R12	10 x 8	25 x 22	25 x 22	
	* LQ1T61-R13	8 x 6	25 x 22	25 x 22	
	LQ1T61-R15	6 x 4	25 x 22	25 x 22	
	LQ1T61-R18	10 x 8	19 x 16	25 x 22	
	LQ1T61-R19	6 x 4	19 x 16	25 x 22	
	LQ1T61-R20	19 x 16	12 x 10	25 x 22	
	* LQ1T61-R26	25 x 22	6 x 4	25 x 22	
	LQ1T61-R30	10 x 8	25 x 22	19 x 16	
	LQ1T61-R31	12 x 10	25 x 22	19 x 16	
* LQ1T61-R34	6 x 4	25 x 22	6 x 4		

Note 1) Products marked "*" are produced upon receipt of order.
Note 2) For details of the applicable tubing sizes, refer to page 72.

Size combination (Inch)

Class	Model	Applicable tubing size (inch)		
		A side	B side	C side
2	LQ1T2A-R1	1/4" x 5/32"	3/16" x 1/8"	1/4" x 5/32"
	LQ1T2A-R2	1/4" x 5/32"	1/8" x 0.086"	1/4" x 5/32"
	LQ1T2A-R9	3/16" x 1/8"	1/4" x 5/32"	3/16" x 1/8"
	LQ1T2A-R10	1/8" x 0.086"	1/4" x 5/32"	1/8" x 0.086"
	LQ1T2B-R1	3/16" x 1/8"	1/8" x 0.086"	3/16" x 1/8"
	LQ1T2B-R9	1/8" x 0.086"	3/16" x 1/8"	1/8" x 0.086"
3	LQ1T3A-R1	3/8" x 1/4"	1/4" x 5/32"	3/8" x 1/4"
	LQ1T3A-R5	1/4" x 5/32"	3/8" x 1/4"	3/8" x 1/4"
	LQ1T3A-R7	1/4" x 5/32"	1/4" x 5/32"	3/8" x 1/4"
	LQ1T3A-R9	1/4" x 5/32"	3/8" x 1/4"	1/4" x 5/32"
	LQ1T4A-R1	1/2" x 3/8"	3/8" x 1/4"	1/2" x 3/8"
	LQ1T4A-R2	1/2" x 3/8"	1/4" x 5/32"	1/2" x 3/8"
4	LQ1T4A-R4	1/2" x 3/8"	1/8" x 0.086"	1/2" x 3/8"
	LQ1T4A-R5	3/8" x 1/4"		1/2" x 3/8"
	LQ1T4A-R6	1/4" x 5/32"	1/2" x 3/8"	1/2" x 3/8"
	LQ1T4A-R7	3/8" x 1/4"	3/8" x 1/4"	1/2" x 3/8"
	LQ1T4A-R8	1/4" x 5/32"	1/4" x 5/32"	1/2" x 3/8"
	LQ1T4A-R9	3/8" x 1/4"	1/2" x 3/8"	3/8" x 1/4"
	LQ1T4A-R10	1/4" x 5/32"	1/2" x 3/8"	1/4" x 5/32"
	LQ1T4A-R17	1/4" x 5/32"	3/8" x 1/4"	1/2" x 3/8"
	LQ1T4A-R20	3/8" x 1/4"	1/4" x 5/32"	1/2" x 3/8"
	LQ1T4A-R33	1/8" x 0.086"	1/2" x 3/8"	1/8" x 0.086"
	LQ1T5A-R1	3/4" x 5/8"	1/2" x 3/8"	3/4" x 5/8"
	LQ1T5A-R2	3/4" x 5/8"	3/8" x 1/4"	3/4" x 5/8"
	LQ1T5A-R5	1/2" x 3/8"	3/4" x 5/8"	3/4" x 5/8"
	LQ1T5A-R6	3/8" x 1/4"	3/4" x 5/8"	3/4" x 5/8"
* LQ1T5A-R7	1/2" x 3/8"	1/2" x 3/8"	3/4" x 5/8"	
LQ1T5A-R8	3/8" x 1/4"	3/8" x 1/4"	3/4" x 5/8"	
LQ1T5A-R9	1/2" x 3/8"		1/2" x 3/8"	
* LQ1T5A-R10	3/8" x 1/4"	3/4" x 5/8"	3/8" x 1/4"	
LQ1T5A-R12	1/4" x 5/32"		3/4" x 5/8"	
* LQ1T5A-R17	1/2" x 3/8"	3/8" x 1/4"	3/4" x 5/8"	
LQ1T5A-R21	3/8" x 1/4"	1/4" x 5/32"	3/4" x 5/8"	
LQ1T5A-R22	1/2" x 3/8"	1/4" x 5/32"	3/4" x 5/8"	
LQ1T5A-R26	3/4" x 5/8"	1/8" x 0.086"	3/4" x 5/8"	
LQ1T5A-R31	3/8" x 1/4"		1/2" x 3/8"	
* LQ1T5A-R32	1/4" x 5/32"	3/4" x 5/8"	1/4" x 5/32"	
5	LQ1T6A-R1	1" x 7/8"	3/4" x 5/8"	1" x 7/8"
	LQ1T6A-R2	1" x 7/8"	1/2" x 3/8"	1" x 7/8"
	LQ1T6A-R3	1" x 7/8"	3/8" x 1/4"	1" x 7/8"
	* LQ1T6A-R4	1" x 7/8"	1/4" x 5/32"	1" x 7/8"
	LQ1T6A-R5	3/4" x 5/8"		1" x 7/8"
	LQ1T6A-R6	1/2" x 3/8"	1" x 7/8"	1" x 7/8"
	LQ1T6A-R7	3/4" x 5/8"	3/4" x 5/8"	1" x 7/8"
	* LQ1T6A-R8	1/2" x 3/8"	1/2" x 3/8"	1" x 7/8"
	LQ1T6A-R9	3/4" x 5/8"		3/4" x 5/8"
	LQ1T6A-R10	1/2" x 3/8"	1" x 7/8"	1/2" x 3/8"
	LQ1T6A-R11	3/8" x 1/4"	3/4" x 5/8"	1" x 7/8"
	LQ1T6A-R12	3/8" x 1/4"		1" x 7/8"
	* LQ1T6A-R13	1/4" x 5/32"	1" x 7/8"	1" x 7/8"
	LQ1T6A-R17	1/2" x 3/8"		1" x 7/8"
* LQ1T6A-R18	1/4" x 5/32"	3/4" x 5/8"	1" x 7/8"	
LQ1T6A-R20	3/4" x 5/8"	1/2" x 3/8"	1" x 7/8"	
LQ1T6A-R30	3/8" x 1/4"		3/4" x 5/8"	
* LQ1T6A-R31	1/2" x 3/8"	1" x 7/8"	3/4" x 5/8"	
* LQ1T6A-R33	1/4" x 5/32"		1/4" x 5/32"	

Note 1) Products marked "*" are produced upon receipt of order.
Note 2) For details of the applicable tubing sizes, refer to page 72.

Series LQ1

Dimensions

Union tee reducing: LQ1T-R

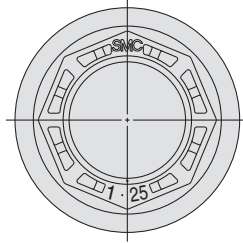

Class 6

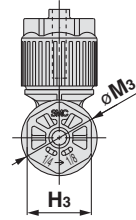

Class 2 to 5

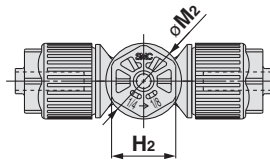
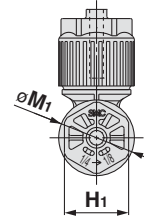
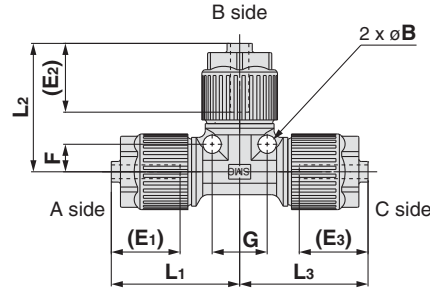

Metric Size

Model	A side	B side	C side	B	E ₁	E ₂	E ₃	F	G	H ₁	H ₂	H ₃	L ₁	L ₂	L ₃	M ₁	M ₂	M ₃															
	Applicable tubing O.D.																																
LQ1T21-R1	ø6	ø4	ø6	4	15	15	15	6	12	14	14	14	28	28	28	16.5	16.5	16.5															
LQ1T21-R2	ø6	ø3	ø6																														
LQ1T21-R9	ø4	ø6	ø4																														
LQ1T21-R10	ø3	ø6	ø3																														
LQ1T22-R1	ø4	ø3	ø4																														
LQ1T22-R9	ø3	ø4	ø3																														
LQ1T31-R1	ø10	ø8	ø10	5	20	20	20	9	18	17	17	17	36.5	36.5	36.5	23	23	23															
LQ1T31-R2	ø10	ø6	ø10																														
LQ1T31-R4	ø10	ø3	ø10	6	24	15	24	9	18	21	14	21	43	33	43	28	16.5	28															
LQ1T31-R7	ø8	ø8	ø10																														
LQ1T31-R8	ø6	ø6	ø10																														
LQ1T31-R9	ø8	ø10	ø8																														
LQ1T31-R10	ø6	ø10	ø6																														
LQ1T32-R1	ø8	ø6	ø8																5	20	20	20	9	18	17	17	17	36.5	36.5	36.5	23	23	23
LQ1T32-R5	ø6	ø8	ø8																														
LQ1T32-R6	ø6	ø10	ø10																														
LQ1T32-R7	ø6	ø6	ø8																														
LQ1T32-R9	ø6	ø8	ø6																														
LQ1T41-R1	ø12	ø10	ø12	6	24	24	24	9	18	21	21	21	43	43	43	28	16.5	28															
LQ1T41-R2	ø12	ø8	ø12																														
LQ1T41-R3	ø12	ø6	ø12																														
LQ1T41-R5	ø10	ø12	ø12																														
LQ1T41-R7	ø10	ø10	ø12																														
LQ1T41-R9	ø10	ø12	ø10																														
LQ1T41-R11	ø6	ø10	ø12																7	20	20	29	14	28	17	17	26	44	44	54	23	23	39
LQ1T41-R12	ø6	ø12	ø12																														
LQ1T41-R22	ø10	ø6	ø12																6	24	20	24	9	18	21	21	21	43	38.5	43	28	23	28
LQ1T41-R23	ø6	ø6	ø12																														
LQ1T41-R26	ø12	ø3	ø12																														
LQ1T41-R32	ø6	ø12	ø6																														
LQ1T41-R34	ø3	ø12	ø3																														
LQ1T51-R1	ø19	ø12	ø19	7	29	29	29	14	28	26	26	26	54	54	54	39	39	39															
LQ1T51-R2	ø19	ø10	ø19																														
LQ1T51-R3	ø19	ø8	ø19																														

Metric Size

Model	A side Applicable tubing O.D.	B side	C side	B	E ₁	E ₂	E ₃	F	G	H ₁	H ₂	H ₃	L ₁	L ₂	L ₃	M ₁	M ₂	M ₃														
LQ1T51-R4	ø19	ø6	ø19	7	29	15	29	14	28	26	14	26	54	38.5	54	39	16.5	39														
LQ1T51-R5	ø12	ø19	ø19			20					29		26	44			54		23													
LQ1T51-R6	ø10	ø19	ø19			20					29		17	26			44		23													
* LQ1T51-R7	ø12	ø12	ø19	—	24	24	39.5	—	—	21	21	36	42	52.5	57.5	28	28	49														
* LQ1T51-R8	ø10	ø10	ø19	7	29	15	29	14	28	26	14	26	54	38.5	54	39	16.5	39														
LQ1T51-R9	ø12	ø19	ø12																29	29	29	26	26	26	54	54	39					
LQ1T51-R10	ø10	ø19	ø10																20	29	24	17	26	21	54	49	39					
LQ1T51-R12	ø8	ø19	ø19																20	29	29	17	26	26	44	54	23	39				
LQ1T51-R13	ø6	ø19	ø19																20	29	24	17	26	26	44	54	23	39				
* LQ1T51-R17	ø10	ø12	ø19	—	24	24	39.5	18	36	21	21	36	42	52.5	57.5	28	28	49														
LQ1T51-R24	ø12	ø6	ø19	7	29	15	29	14	28	26	14	26	54	38.5	54	39	16.5	39														
LQ1T51-R26	ø19	ø4	ø19																20	29	24	17	26	21	44	54	49	23	39			
LQ1T51-R28	ø19	ø3	ø19																20	29	24	17	26	21	44	54	49	23	39			
LQ1T51-R31	ø10	ø19	ø12																20	29	24	17	26	21	44	54	49	23	39			
LQ1T61-R1	ø25	ø19	ø25	8	39.5	39.5	39.5	18	36	36	21	36	69.5	69.5	69.5	49	49	49														
LQ1T61-R2	ø25	ø12	ø25			24								39.5			18		36	21	36	69.5	54.5	69.5	28							
LQ1T61-R3	ø25	ø10	ø25			20								39.5			—		—	17	36	55	47.5	55	23							
* LQ1T61-R4	ø25	ø8	ø25	—	8	24	39.5	18	36	36	36	36	69.5	69.5	69.5	49	49	49														
LQ1T61-R5	ø19	ø25	ø25	39.5															18	36	21	36	69.5	69.5	69.5	49						
LQ1T61-R6	ø12	ø25	ø25	39.5															18	36	36	36	54.5	69.5	69.5	28						
LQ1T61-R7	ø19	ø19	ø25	39.5															18	36	36	36	69.5	69.5	69.5	49						
* LQ1T61-R8	ø12	ø12	ø25	—	24	24	39.5	—	—	21	21	36	47	52.5	57.5	28	28	49														
LQ1T61-R9	ø19	ø25	ø19	8	39.5	39.5	24	18	36	36	36	21	54.5	69.5	69.5	49	49	28														
LQ1T61-R10	ø12	ø25	ø12																24	18	36	21	36	21	54.5	69.5	54.5	28				
LQ1T61-R11	ø12	ø19	ø25	8	24	39.5	39.5	18	36	21	36	36	54.5	69.5	68.5	28	49	49														
* LQ1T61-R13	ø8	ø25	ø25																—	20	39.5	39.5	—	—	17	36	36	46.5	68	68	23	49
LQ1T61-R15	ø6	ø25	ø25																15	39.5	39.5	39.5	18	36	14	36	36	44	69.5	69.5	16.5	49
LQ1T61-R18	ø10	ø19	ø25	8	24	39.5	39.5	18	36	21	36	36	54.5	69.5	69.5	28	49	49														
LQ1T61-R19	ø6	ø19	ø25	15	39.5														39.5	39.5	18	36	14	36	36	44	69.5	69.5	16.5	49		
LQ1T61-R20	ø19	ø12	ø25	24	39.5														39.5	39.5	18	36	21	36	36	69.5	54.5	69.5	49	28		
* LQ1T61-R26	ø25	ø6	ø25	—	39.5	20	39.5	—	—	36	17	36	55	47.5	55	49	23	49														
LQ1T61-R30	ø10	ø25	ø19	8	24	39.5	20	18	36	21	36	36	54.5	69.5	49.5	28	49	23														
LQ1T61-R31	ø12	ø25	ø19																20	39.5	20	18	36	21	36	36	54.5	69.5	49.5	28	49	
* LQ1T61-R34	ø6	ø25	ø6																—	20	20	20	—	—	17	36	17	46.5	55	46.5	23	23

Note) Products marked "*" are produced upon receipt of order.

LQ1

LQ3

LVN

LQHB

TL/TIL

TD/TID

TH/THH

Applicable Fluid

Precautions

Series LQ1

Dimensions

Union tee reducing: LQ1T-R

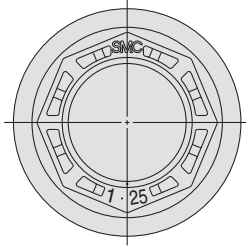

Class 6

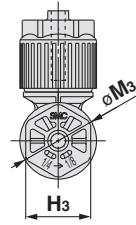

Class 2 to 5

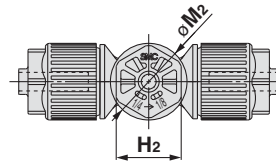
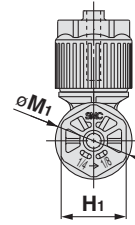
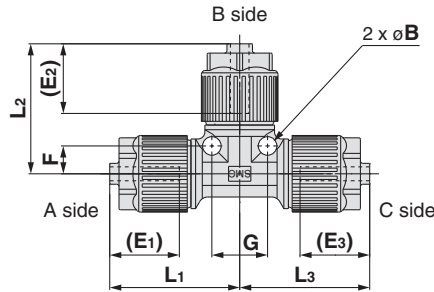

Inch Size

Model	A side	B side	C side	B	E ₁	E ₂	E ₃	F	G	H ₁	H ₂	H ₃	L ₁	L ₂	L ₃	M ₁	M ₂	M ₃	
	Applicable tubing O.D.																		
LQ1T2A-R1	1/4"	3/16"	1/4"	4	15	15	15	6	12	14	14	14	28	28	28	16.5	16.5	16.5	
LQ1T2A-R2	1/4"	1/8"	1/4"																
LQ1T2A-R9	3/16"	1/4"	3/16"																
LQ1T2A-R10	1/8"	1/4"	1/8"																
LQ1T2B-R1	3/16"	1/8"	3/16"																
LQ1T2B-R9	1/8"	3/16"	1/8"	5	20	20	20	9	18	17	17	17	36.5	36.5	36.5	23	23	23	
LQ1T3A-R1	3/8"	1/4"	3/8"																
LQ1T3A-R5	1/4"	3/8"	3/8"																
LQ1T3A-R7	1/4"	1/4"	3/8"																
LQ1T3A-R9	1/4"	3/8"	1/4"																
LQ1T4A-R1	1/2"	3/8"	1/2"	6	24	24	24	9	18	21	21	21	43	43	43	28	28	28	
LQ1T4A-R2	1/2"	1/4"	1/2"			15					14						33		16.5
LQ1T4A-R4	1/2"	1/8"	1/2"			24					21						43		28
LQ1T4A-R5	3/8"	1/2"	1/2"			24					21						43		28
LQ1T4A-R6	1/4"	1/2"	1/2"			7					20						29		29
LQ1T4A-R7	3/8"	3/8"	1/2"	6	24	24	24	9	18	21	21	21	43	43	43	28	28	28	
LQ1T4A-R8	1/4"	1/4"	1/2"	7	20	20	29	14	28	17	17	26	44	44	54	23	23	39	
LQ1T4A-R9	3/8"	1/2"	3/8"	6	24	24	24	9	18	21	21	21	43	43	43	28	28	28	
LQ1T4A-R10	1/4"	1/2"	1/4"		15	15	14			33	33	16.5	28	16.5					
LQ1T4A-R17	1/4"	3/8"	1/2"		20	29	17			26	44	44	54	23	39				
LQ1T4A-R20	3/8"	1/4"	1/2"		24	24	17			21	43	38.5	43	28	23	28			
LQ1T4A-R33	1/8"	1/2"	1/8"		15	24	15			14	21	14	33	43	33	16.5	28	16.5	
LQ1T5A-R1	3/4"	1/2"	3/4"	7	29	29	29	14	28	26	26	26	54	54	54	39	39	39	
LQ1T5A-R2	3/4"	3/8"	3/4"			20					17			44			23		
LQ1T5A-R5	1/2"	3/4"	3/4"			29					26			54			39		
LQ1T5A-R6	3/8"	3/4"	3/4"			20					17			54			39		
* LQ1T5A-R7	1/2"	1/2"	3/4"			—					24			24			39.5		—
LQ1T5A-R8	3/8"	3/8"	3/4"	7	20	20	29	14	28	17	17	26	44	44	54	23	23	39	

Note) Products marked "*" are produced upon receipt of order.

Inch Size

Model	A side	B side	C side	B	E ₁	E ₂	E ₃	F	G	H ₁	H ₂	H ₃	L ₁	L ₂	L ₃	M ₁	M ₂	M ₃													
	Applicable tubing O.D.																														
LQ1T5A-R9	1/2"	3/4"	1/2"	7	29	29	29	14	28	26	26	26	54	54	54	39	39	39													
* LQ1T5A-R10	3/8"	3/4"	3/8"	—	20	39.5	20	—	—	17	36	17	46.5	55	46.5	23	49	23													
LQ1T5A-R12	1/4"	3/4"	3/4"	7	15	29	29	14	28	14	26	26	38.5	54	54	16.5	39	39													
* LQ1T5A-R17	1/2"	3/8"	3/4"	—	24	24	39.5	—	—	21	21	36	42	52.5	57.5	28	28	49													
LQ1T5A-R21	3/8"	1/4"	3/4"	7	20	20	29	14	28	17	17	26	44	44	54	23	23	39													
LQ1T5A-R22	1/2"	1/4"	3/4"		29	15				26	14		26	54		38.5	39		16.5												
LQ1T5A-R26	3/4"	1/8"	3/4"		20	29				24	17		26	21		44	54		49	23	39	28									
LQ1T5A-R31	3/8"	3/4"	1/2"		39.5	20	—			—	36		17	46.5	55	46.5	49		23	49	23										
* LQ1T5A-R32	1/4"	3/4"	1/4"	—	20	39.5	20	—	—	17	36	17	46.5	55	46.5	23	49	23													
LQ1T6A-R1	1"	3/4"	1"	8	39.5	39.5	24	18	36	36	21	36	69.5	54.5	69.5	49	28	49													
LQ1T6A-R2	1"	1/2"	1"			24													36	17	55	47.5	55	23							
LQ1T6A-R3	1"	3/8"	1"			39.5													36	36	69.5	69.5	69.5	28	49						
* LQ1T6A-R4	1"	1/4"	1"			—													20	—	—	21	21	42	52.5	57.5	28	28			
LQ1T6A-R5	3/4"	1"	1"	8	24	39.5	39.5	18	36	21	36	36	69.5	54.5	69.5	28	49	49													
LQ1T6A-R6	1/2"	1"	1"																39.5	36	36	69.5	69.5	69.5	49	49					
LQ1T6A-R7	3/4"	3/4"	1"																—	24	24	—	—	21	21	42	52.5	57.5	28	28	
* LQ1T6A-R8	1/2"	1/2"	1"																8	39.5	39.5	18	36	36	36	69.5	69.5	69.5	49	49	
LQ1T6A-R9	3/4"	1"	3/4"	8	39.5	39.5	24	18	36	36	36	21	54.5	—	—	—	—	28													
LQ1T6A-R10	1/2"	1"	1/2"	8	24	39.5	39.5	18	36	21	36	36	54.5	69.5	69.5	28	49	49													
LQ1T6A-R11	3/8"	3/4"	1"																—	20	—	—	17	—	—	17	36	46.5	68	68	23
LQ1T6A-R12	3/8"	1"	1"																8	24	—	—	17	18	36	21	36	54.5	69.5	69.5	28
* LQ1T6A-R13	1/4"	1"	1"																—	20	—	—	17	18	36	21	36	46.5	68	68	23
LQ1T6A-R17	1/2"	3/4"	1"	8	24	—	—	17	18	36	21	36	54.5	69.5	69.5	28															
* LQ1T6A-R18	1/4"	3/4"	1"	—	20	39.5	39.5	18	36	21	36	36	69.5	54.5	69.5	28	49	49													
LQ1T6A-R20	3/4"	1/2"	1"	8	39.5	24													—	—	17	36	21	36	46.5	68	68	23	49		
LQ1T6A-R30	3/8"	1"	3/4"	—	20	—													—	17	18	36	21	36	54.5	69.5	69.5	28	49		
LQ1T6A-R31	1/2"	1"	3/4"	8	24	39.5													20	—	—	17	—	—	17	46.5	55	46.5	23	49	
* LQ1T6A-R33	1/4"	1"	1/4"	—	20	—	—	17	—	—	17	17	46.5	55	46.5	23	49	23													

Note) Products marked "*" are produced upon receipt of order.

LQ1
LQ3
LVN
LQHB
TL/TIL
TD/TID
TH/TIH
Applicable Fluid
Precautions

Series LQ1

Panel Mount Union Reducing

How to Order

Tubing connection

Fitting type

Symbol	Type
P	Panel mount union

Body size (according to the combination table)

Piping type (according to the combination table)

Symbol	Type
R□	Reducing

Packaging

Symbol	Packaging
—	Clean packaging equivalent to Class M3.5
1	Standard packaging equivalent to Class M5.5

Tubing type

Symbol	Type
1, 2	Metric
A, B	Inch

Size combination (Metric)

Class	Model	A side	B side
		Applicable tubing size (mm)	
2	LQ1P21-R1	6 x 4	4 x 3
	LQ1P21-R2	6 x 4	3 x 2
3	LQ1P22-R1	4 x 3	3 x 2
	LQ1P31-R1	10 x 8	8 x 6
4	LQ1P31-R2	10 x 8	6 x 4
	LQ1P32-R1	8 x 6	6 x 4
5	LQ1P41-R1	12 x 10	10 x 8
	* LQ1P41-R3	12 x 10	6 x 4
6	LQ1P51-R1	19 x 16	12 x 10
	* LQ1P51-R2	19 x 16	10 x 8
6	LQ1P61-R1	25 x 22	19 x 16

Size combination (Inch)

Class	Model	A side	B side
		Applicable tubing size (inch)	
2	LQ1P2A-R1	1/4" x 5/32"	3/16" x 0.127"
	LQ1P2A-R2	1/4" x 5/32"	1/8" x 0.086"
3	LQ1P2B-R1	3/16" x 0.127"	1/8" x 0.086"
3	LQ1P3A-R1	1/4" x 5/32"	3/8" x 1/4"
4	LQ1P4A-R1	1/2" x 3/8"	3/8" x 1/4"
	* LQ1P4A-R2	1/2" x 3/8"	1/4" x 5/32"
5	LQ1P5A-R1	3/4" x 5/8"	1/2" x 3/8"
	* LQ1P5A-R2	3/4" x 5/8"	3/8" x 1/4"
6	LQ1P6A-R1	1" x 7/8"	3/4" x 5/8"

Note 1) Products marked "*" are produced upon receipt of order.
 Note 2) For details of the applicable tubing sizes, refer to page 72.

Dimensions

Panel mount union reducing: LQ1P-R

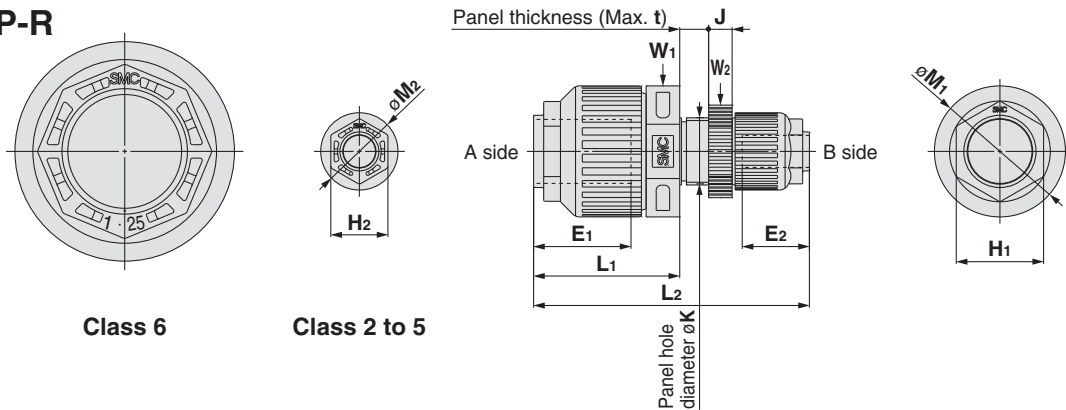

Metric Size

Model	A side	B side	E ₁	E ₂	H ₁	H ₂	J	K	L ₁	L ₂	M ₁	M ₂	t	W ₁	W ₂
	Applicable tubing O.D.														
LQ1P21-R1	ø6	ø4	15	15	14	14	6	14.5	23.5	55.5	16.5	16.5	8	15	17
LQ1P21-R2	ø6	ø3													
LQ1P22-R1	ø4	ø3													
LQ1P31-R1	ø10	ø8	20	20	17	17	7	20.5	30	69	23	23	8	21	24
LQ1P31-R2	ø10	ø6													
LQ1P32-R1	ø8	ø6													
LQ1P41-R1	ø12	ø10	24	24	21	21	7	24.5	35	78.5	28	28	8	26	28
* LQ1P41-R3	ø12	ø6	29	20	26	17		20.5	43.5	82.1	39	23		39	23
LQ1P51-R1	ø19	ø12	29	29	26	26	9	36.5	43.5	100	39	39	9	39	43
* LQ1P51-R2	ø19	ø10													
LQ1P61-R1	ø25	ø19	39.5	39.5	36	36	10	48.5	58.5	133	49	49	10	51	55

Inch Size

Model	A side	B side	E ₁	E ₂	H ₁	H ₂	J	K	L ₁	L ₂	M ₁	M ₂	t	W ₁	W ₂
	Applicable tubing O.D.														
LQ1P2A-R1	1/4"	3/16"	15	15	14	14	6	14.5	23.5	55.5	16.5	16.5	8	15	17
LQ1P2A-R2	1/4"	1/8"													
LQ1P2B-R1	3/16"	1/8"													
LQ1P3A-R1	1/4"	3/8"	20	20	17	17	7	20.5	30	69	23	23	8	21	24
LQ1P4A-R1	1/2"	3/8"	24	24	21	21		24.5	35	78.5	28	28		8	26
* LQ1P4A-R2	1/2"	1/4"	29	20	26	17	20.5	43.5	82.1	39	23	39	23	39	24
LQ1P5A-R1	3/4"	1/2"	29	29	26	26	9	30.5	43.5	100	39	39	9	39	43
* LQ1P5A-R2	3/4"	3/8"													
LQ1P6A-R1	1"	3/4"	39.5	39.5	36	36	10	48.5	58.5	133	49	49	10	51	55

Note) Products marked "*" are produced upon receipt of order.

Series LQ1 Union Reducing

How to Order

Tubing connection

LQ1 U 2 1 - R1 -

Fitting type

Symbol	Type
U	Union

Body size
(according to the combination table)

Tubing type

Symbol	Type
1, 2	Metric
A, B	Inch

Piping type (according to the combination table)

Symbol	Type
R□	Reducing

Packaging

Symbol	Packaging
—	Clean packaging equivalent to Class M3.5
1	Standard packaging equivalent to Class M5.5

Size combination (Metric)

Class	Model	Applicable tubing size (mm)	
		A side	B side
2	LQ1U21-R1	6 x 4	4 x 3
	LQ1U21-R2		3 x 2
	LQ1U22-R1		3 x 2
3	LQ1U31-R1	10 x 8	8 x 6
	LQ1U31-R2		6 x 4
	LQ1U31-R3		4 x 3
	LQ1U31-R4		3 x 2
	LQ1U32-R1		8 x 6
	LQ1U41-R1		6 x 4
4	LQ1U41-R1	12 x 10	10 x 8
	LQ1U41-R2		8 x 6
	LQ1U41-R3		6 x 4
	LQ1U41-R4		4 x 3
	LQ1U41-R5		3 x 2
	LQ1U51-R1		12 x 10
5	LQ1U51-R1	19 x 16	10 x 8
	* LQ1U51-R2		8 x 6
	* LQ1U51-R3		6 x 4
	LQ1U51-R4		4 x 3
	LQ1U51-R5		3 x 2
	LQ1U51-R6		19 x 16
6	LQ1U61-R1	25 x 22	12 x 10
	LQ1U61-R2		10 x 8
	LQ1U61-R3		10 x 8
	* LQ1U61-R5		6 x 4

Size combination (Inch)

Class	Model	Applicable tubing size (inch)	
		A side	B side
2	LQ1U2A-R1	1/4" x 5/32"	3/16" x 1/8"
	LQ1U2A-R2		1/8" x 0.086"
	LQ1U2B-R1		1/8" x 0.086"
3	LQ1U3A-R1	3/16" x 0.127"	1/4" x 5/32"
	LQ1U3A-R2		3/16" x 0.127"
	LQ1U3A-R3		1/8" x 0.086"
4	LQ1U4A-R1	1/2" x 3/8"	3/8" x 1/4"
	LQ1U4A-R2		1/2" x 5/32"
	LQ1U4A-R3		3/16" x 0.127"
	LQ1U4A-R4		1/8" x 0.086"
5	LQ1U5A-R1	3/4" x 5/8"	1/2" x 3/8"
	* LQ1U5A-R2		3/8" x 1/4"
	LQ1U5A-R3		1/4" x 5/32"
	LQ1U5A-R4		3/16" x 0.127"
	LQ1U5A-R5		1/8" x 0.086"
6	LQ1U6A-R1	1" x 7/8"	3/4" x 5/8"
	LQ1U6A-R2		1/2" x 3/8"
	LQ1U6A-R3		3/8" x 1/4"
	* LQ1U6A-R4		1/4" x 5/32"

Note 1) Products marked "*" are produced upon receipt of order.
Note 2) For details of the applicable tubing sizes, refer to page 72.

Note 1) Products marked "*" are produced upon receipt of order.
Note 2) For details of the applicable tubing sizes, refer to page 72.

Dimensions

Union reducing: LQ1U-R

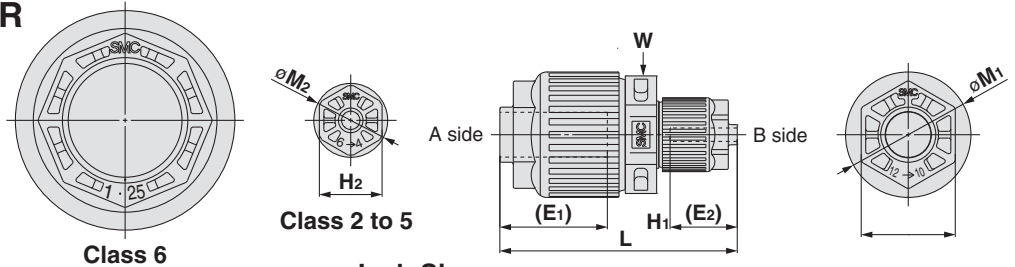

Metric Size

Model	A side Applicable tubing O.D.	B side Applicable tubing O.D.	E1	E2	H1	H2	L	M1	M2	W
LQ1U21-R1	ø6	ø4	15	15	14	14	41	16.5	16.5	14
LQ1U21-R2	ø6	ø3								
LQ1U22-R1	ø4	ø3								
LQ1U31-R1	ø10	ø8	20	20	17	17	54	23	23	19
LQ1U31-R2	ø10	ø6								
LQ1U31-R3	ø10	ø4								
LQ1U31-R4	ø10	ø3	24	15	21	14	53	28	16.5	23
LQ1U32-R1	ø8	ø6								
LQ1U41-R1	ø12	ø10								
LQ1U41-R2	ø12	ø8	24	20	21	14	53	28	16.5	23
LQ1U41-R3	ø12	ø6								
LQ1U41-R4	ø12	ø4								
LQ1U41-R5	ø12	ø3	29	29	26	17	66.5	39	23	32
LQ1U51-R1	ø19	ø12								
* LQ1U51-R2	ø19	ø10								
* LQ1U51-R3	ø19	ø8								
LQ1U51-R4	ø19	ø6								
LQ1U51-R5	ø19	ø4								
LQ1U51-R6	ø19	ø3	39.5	24	36	21	87	49	28	46
LQ1U61-R1	ø25	ø19								
LQ1U61-R2	ø25	ø12								
LQ1U61-R3	ø25	ø10								
* LQ1U61-R5	ø25	ø6	20			17	82		23	36

Note) Products marked "*" are produced upon receipt of order.

Inch Size

Model	A side Applicable tubing O.D.	B side Applicable tubing O.D.	E1	E2	H1	H2	L	M1	M2	W
LQ1U2A-R1	1/4"	3/16"	15	15	14	14	41	16.5	16.5	14
LQ1U2A-R2	1/4"	1/8"								
LQ1U2B-R1	3/16"	0.127"								
LQ1U3A-R1	3/8"	1/4"	20	20	17	17	54	23	23	19
LQ1U3A-R2	3/8"	3/16"								
LQ1U3A-R3	3/8"	1/8"								
LQ1U4A-R1	1/2"	3/8"	24	15	21	14	53	28	16.5	23
LQ1U4A-R2	1/2"	1/4"								
LQ1U4A-R3	1/2"	3/16"								
LQ1U4A-R4	1/2"	1/8"								
LQ1U5A-R1	3/4"	1/2"	29	29	26	14	61.5	39	23	32
* LQ1U5A-R2	3/4"	3/8"								
LQ1U5A-R3	3/4"	1/4"								
LQ1U5A-R4	3/4"	3/16"								
LQ1U5A-R5	3/4"	1/8"								
LQ1U6A-R1	1"	3/4"	39.5	24	36	21	87	49	28	46
LQ1U6A-R2	1"	1/2"								
LQ1U6A-R3	1"	3/8"								
* LQ1U6A-R4	1"	1/4"								

Note) Products marked "*" are produced upon receipt of order.

Series LQ1 Space Saving Union Elbow

How to Order

Tubing connection LQ1 E 21 - SS - []

Fitting type

Symbol	Type
E	Union elbow

Packaging

Symbol	Packaging
—	Clean packaging equivalent to Class M3.5
1	Standard packaging equivalent to Class M5.5

Piping type

Symbol	Type
SS	Space saving

Size combination

Symbol		Applicable tubing size (mm)	
Class	No.		
2	1		6 x 4
3	1		10 x 8
3	2		8 x 6
4	1		12 x 10
5	1	*	19 x 16
6	1		25 x 22

Symbol		Applicable tubing size (inch)	
Class	No.		
2	A		1/4" x 5/32"
3	A		3/8" x 1/4"
4	A		1/2" x 3/8"
5	A	*	3/4" x 5/8"
6	A		1" x 7/8"

Note 1) Products marked "*" are produced upon receipt of order.
Note 2) For details of the applicable tubing sizes, refer to page 72.

Dimensions

Space saving union elbow: LQ1E-SS

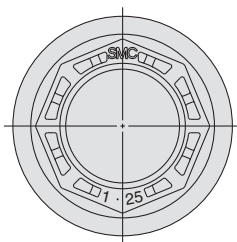

Class 6

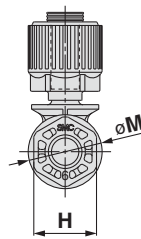

Class 2 to 5

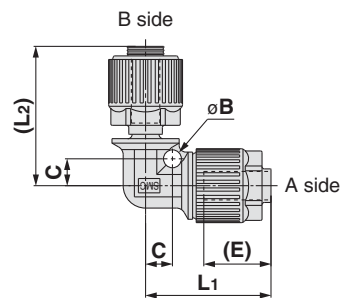

Metric Size

Model	A side	B side	B	C	E	H	L ₁	L ₂	M
	Applicable tubing O.D.	Applicable body size							
LQ1E21-SS	ø6	2	4	6	15	14	28	31.1	16.5
LQ1E31-SS	ø10	3	5	9	20	17	36.6	41.1	23
LQ1E32-SS	ø8	3							
LQ1E41-SS	ø12	4	6	9	24	21	43	47.5	28
* LQ1E51-SS	ø19	5	—	—	29	26	45.5	59	39
LQ1E61-SS	ø25	6	8	18	39.5	36	69.5	75.5	49

Note) Products marked "*" are produced upon receipt of order.

Inch Size

Model	A side	B side	B	C	E	H	L ₁	L ₂	M
	Applicable tubing O.D.	Applicable body size							
LQ1E2A-SS	1/4"	2	4	6	15	14	28	31.1	16.5
LQ1E3A-SS	3/8"	3	5	9	20	17	36.6	41.1	23
LQ1E4A-SS	1/2"	4	6	9	24	21	43	47.5	28
* LQ1E5A-SS	3/4"	5	—	—	29	26	45.5	59	39
LQ1E6A-SS	1"	6	8	18	39.5	36	69.5	75.5	49

Note) Products marked "*" are produced upon receipt of order.

Series LQ1 Space Saving Union Elbow Reducing

How to Order

Tubing connection

LQ1 E 2 1 - SS - R9 -

Fitting type

Symbol	Type
E	Union elbow

Body size
(according to the combination table)

Tubing type

Symbol	Type
1, 2	Metric
A	Inch

Packing

Symbol	Packaging
—	Clean packaging equivalent to Class M3.5
1	Standard packaging equivalent to Class M5.5

Piping type

Symbol	Type
R□	Reducing

Piping type (according to the combination table)

Symbol	Type
SS	Space saving

Size combination (Metric)

Class	Model		A side	B side
			Applicable tubing size (mm)	Applicable body size
2	* LQ1E21-SS-R9		6 x 4	3
	* LQ1E21-SS-R10			4
3	* LQ1E31-SS-R2		10 x 8	2
	* LQ1E31-SS-R8			4
	* LQ1E32-SS-R1			2
	* LQ1E32-SS-R8			3
4	* LQ1E41-SS-R1		12 x 10	3
	* LQ1E41-SS-R3			2
	* LQ1E41-SS-R8			5
6	LQ1E61-SS-R1		25 x 22	5

Size combination (Inch)

Class	Model		A side	B side
			Applicable tubing size (inch)	Applicable body size
2	* LQ1E2A-SS-R8		1/4" x 5/32"	3
	* LQ1E2A-SS-R9			4
3	* LQ1E3A-SS-R1		3/8" x 1/4"	2
	* LQ1E3A-SS-R8			4
4	* LQ1E4A-SS-R1		1/2" x 3/8"	3
	* LQ1E4A-SS-R2			2
6	* LQ1E4A-SS-R8		1" x 7/8"	5
	LQ1E6A-SS-R1			5

Note 1) Products marked "*" are produced upon receipt of order.
Note 2) For details of the applicable tubing sizes, refer to page 72.

Note 1) Products marked "*" are produced upon receipt of order.
Note 2) For details of the applicable tubing sizes, refer to page 72.

Dimensions

Space saving union elbow reducing: LQ1E-SS-R

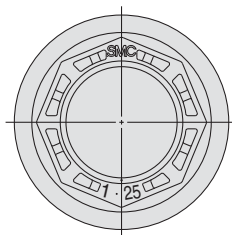

Class 6

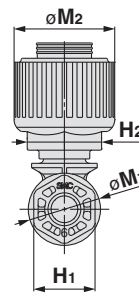

Class 2 to 5

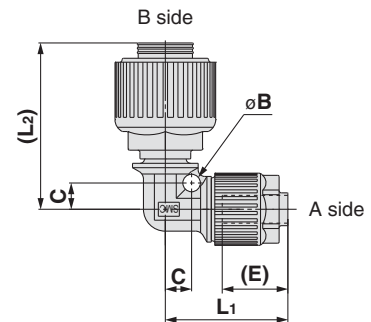

Metric Size

Model	A side Applicable tubing O.D.	B side Applicable body size	B	C	E	H ₁	H ₂	L ₁	L ₂	M ₁	M ₂					
* LQ1E21-SS-R9	ø6	3	—	—	15	14	17	23.5	35.8	16.5	23					
* LQ1E21-SS-R10		4					21	25	40.8		28					
* LQ1E31-SS-R2	ø10	2	—	—	20	17	14	27.2	32.1	23	16.5					
* LQ1E31-SS-R8		4					21	30.4	44		28					
* LQ1E32-SS-R1	ø8	2	—	—	—	—	14	27.2	32.1	—	16.5					
* LQ1E32-SS-R8		3					5	9	17		36.6	41.1	23			
* LQ1E41-SS-R1	ø12	3	—	—	—	—	17	34.8	41.5	—	23					
* LQ1E41-SS-R3		2					6	9	24		21	14	43	35.6	28	16.5
* LQ1E41-SS-R8		5					—	—	—		—	—	26	39.6	49	39
LQ1E61-SS-R1	ø25	5	8	18	39.5	36	26	69.5	64.5	49	39					

Note) Products marked "*" are produced upon receipt of order.

Inch Size

Model	A side Applicable tubing O.D.	B side Applicable body size	B	C	E	H ₁	H ₂	L ₁	L ₂	M ₁	M ₂	
* LQ1E2A-SS-R8	1/4"	3	—	—	15	14	17	23.5	35.8	16.5	23	
* LQ1E2A-SS-R9		4					21	25	40.8		28	
* LQ1E3A-SS-R1	3/8"	2	—	—	20	17	14	27.2	32.1	23	16.5	
* LQ1E3A-SS-R8		4					21	30.4	44		28	
* LQ1E4A-SS-R1	1/2"	3	—	—	24	21	17	34.8	41.5	—	23	
* LQ1E4A-SS-R2		2					14	43	35.6		28	16.5
* LQ1E4A-SS-R8		5					26	39.6	49		39	
LQ1E6A-SS-R1	1"	5	8	18	39.5	36	26	69.5	64.5	49	39	

Note) Products marked "*" are produced upon receipt of order.

Series LQ1 Space Saving Union Tee

How to Order

Tubing connection

LQ1 T 21 - S T1 -

Symbol	Type
T	Union tee

Size combination

Symbol Class	No.	Applicable tubing size (mm)
2	1	6 x 4
3	1	10 x 8
3	2	8 x 6
4	1	12 x 10
5	1	19 x 16
6	1	25 x 22

Symbol Class	No.	Applicable tubing size (inch)
2	A	1/4" x 5/32"
3	A	3/8" x 1/4"
4	A	1/2" x 3/8"
5	A	3/4" x 5/8"
6	A	1" x 7/8"

Note) For details of the applicable tubing sizes, refer to page 72.

Packaging

Symbol	Packaging
—	Clean packaging equivalent to Class M3.5
1	Standard packaging equivalent to Class M5.5

Piping type

Symbol	Type
S	Space saving

Fitting type

Symbol	Type
T1	Type 1
T2	Type 2
T3	Type 3
T4	Type 4

Dimensions

Space saving union tee: LQ1T-ST

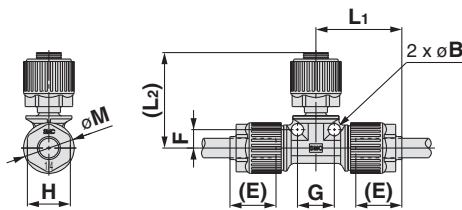

Class 2 to 5

Type T1

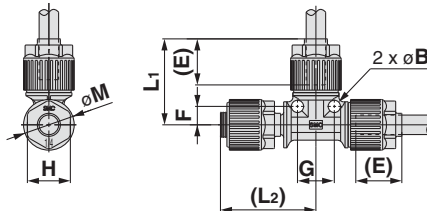

Class 2 to 5

Type T2

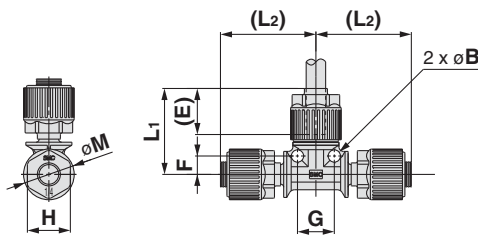

Class 2 to 5

Type T3

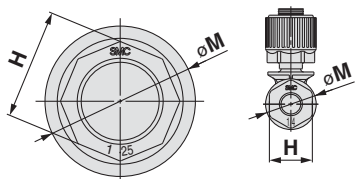

Class 6

Class 2 to 5

Type T4

Metric Size

Model	Applicable tubing O.D.	B	E	F	G	H	L ₁	L ₂	M
LQ1T21-ST1	ø6	4	15	6	12	14	28	31.1	16.5
LQ1T21-ST2									
LQ1T21-ST3									
LQ1T21-ST4									
LQ1T31-ST1	ø10	5	20	9	18	17	36.5	41.1	23
LQ1T31-ST2									
LQ1T31-ST3									
LQ1T31-ST4									
LQ1T32-ST1	ø8	5	20	9	18	17	36.5	41.1	23
LQ1T32-ST2									
LQ1T32-ST3									
LQ1T32-ST4									
LQ1T41-ST1	ø12	6	24	9	18	21	43	47.5	28
LQ1T41-ST2									
LQ1T41-ST3									
LQ1T41-ST4									
LQ1T51-ST1	ø19	7	29	14	28	26	54	59	39
LQ1T51-ST2									
LQ1T51-ST3									
LQ1T51-ST4									
LQ1T61-ST1	ø25	8	39.5	18	36	36	69.5	75.5	49
LQ1T61-ST2									
LQ1T61-ST3									
LQ1T61-ST4									

Inch Size

Model	Applicable tubing O.D.	B	E	F	G	H	L ₁	L ₂	M
LQ1T2A-ST1	1/4"	4	15	6	12	14	28	31.1	16.5
LQ1T2A-ST2									
LQ1T2A-ST3									
LQ1T2A-ST4									
LQ1T3A-ST1	3/8"	5	20	9	18	17	36.5	41.1	23
LQ1T3A-ST2									
LQ1T3A-ST3									
LQ1T3A-ST4									
LQ1T4A-ST1	1/2"	6	24	9	18	21	43	47.5	28
LQ1T4A-ST2									
LQ1T4A-ST3									
LQ1T4A-ST4									
LQ1T5A-ST1	3/4"	7	29	14	28	26	54	59	39
LQ1T5A-ST2									
LQ1T5A-ST3									
LQ1T5A-ST4									
LQ1T6A-ST1	1"	8	39.5	18	36	36	69.5	75.5	49
LQ1T6A-ST2									
LQ1T6A-ST3									
LQ1T6A-ST4									

Series LQ1 Space Saving Union Tee Reducing

How to Order

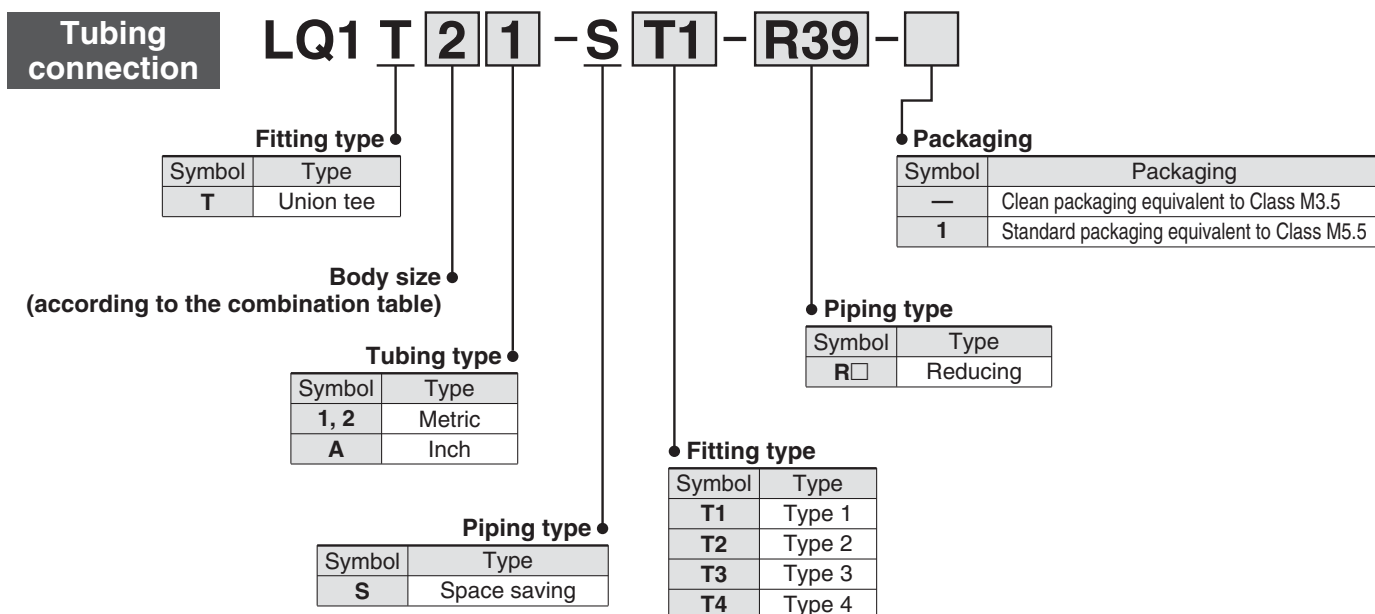

Size combination (Metric)

Class	Model	A side	B side	C side
		Applicable tubing size (O.D. x I.D.) / Applicable body size		
2	LQ1T21-ST1-R39	6 x 4	Body size 3	6 x 4
	LQ1T21-ST2-R41	Body size 3	6 x 4	
3	LQ1T32-ST1-R37	8 x 6	Body size 3	8 x 6
	LQ1T32-ST2-R40	Body size 3	8 x 6	
4	* LQ1T41-ST1-R1	12 x 10	Body size 3	12 x 10
	* LQ1T41-ST1-R37		Body size 5	
5	* LQ1T51-ST1-R1	19 x 16	Body size 4	19 x 16
	* LQ1T51-ST1-R2		Body size 3	
	* LQ1T51-ST1-R5	12 x 10	Body size 5	
	* LQ1T51-ST1-R13	6 x 4		
	* LQ1T51-ST1-R36	12 x 10	Body size 6	
	* LQ1T51-ST1-R37	19 x 16		
6	* LQ1T51-ST2-R4	Body size 5	6 x 4	19 x 16
	* LQ1T61-ST1-R1	25 x 22	Body size 5	
	* LQ1T61-ST1-R2		Body size 4	25 x 22
	* LQ1T61-ST2-R1	Body size 6	19 x 16	

Note 1) Products marked "*" are produced upon receipt of order.

Note 2) For details of the applicable tubing sizes, refer to page 72.

Size combination (Inch)

Class	Model	A side	B side	C side
		Applicable tubing size (O.D. x I.D.) / Applicable body size		
3	LQ1T3A-ST2-R5	Body size 3	3/8" x 1/4"	1/4" x 5/32"
4	* LQ1T4A-ST1-R1	1/2" x 3/8"	Body size 3	1/2" x 3/8"
	* LQ1T4A-ST1-R7	3/8" x 1/4"		
	* LQ1T4A-ST1-R37	1/2" x 3/8"	Body size 5	
5	* LQ1T5A-ST1-R1	3/4" x 5/8"	Body size 4	3/4" x 5/8"
	* LQ1T5A-ST1-R2		Body size 3	
	* LQ1T5A-ST1-R5	1/2" x 3/8"	Body size 5	
	* LQ1T5A-ST1-R7		Body size 4	
	* LQ1T5A-ST1-R12	1/4" x 5/32"	Body size 5	
	* LQ1T5A-ST2-R1	Body size 4	3/4" x 5/8"	
6	* LQ1T5A-ST2-R3	Body size 5	1/4" x 5/32"	Body size 4
	* LQ1T5A-ST3-R5	Body size 4	3/4" x 5/8"	
	* LQ1T6A-ST1-R1	1" x 7/8"	Body size 5	1" x 7/8"
	* LQ1T6A-ST1-R2		Body size 4	
	* LQ1T6A-ST1-R3	Body size 3		
	* LQ1T6A-ST2-R1	Body size 6	3/4" x 5/8"	3/4" x 5/8"
* LQ1T6A-ST2-R2				

Note 1) Products marked "*" are produced upon receipt of order.

Note 2) For details of the applicable tubing sizes, refer to page 72.

Series LQ1

Dimensions

Space saving union tee reducing: LQ1T-S-R

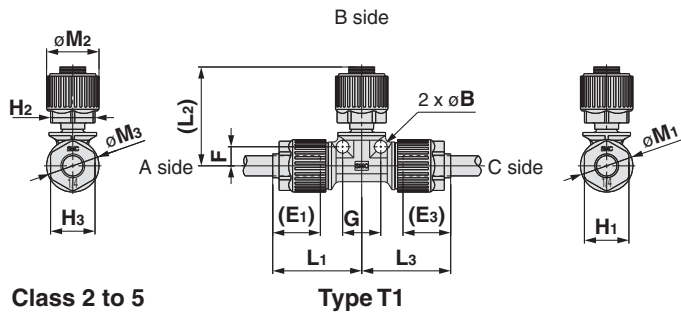

Class 2 to 5

Type T1

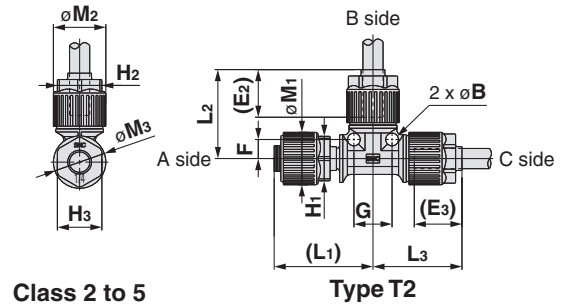

Class 2 to 5

Type T2

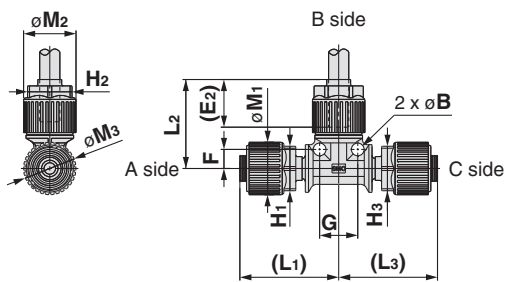

Class 2 to 5

Type T3

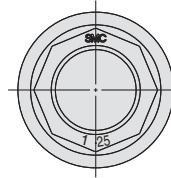

Class 6

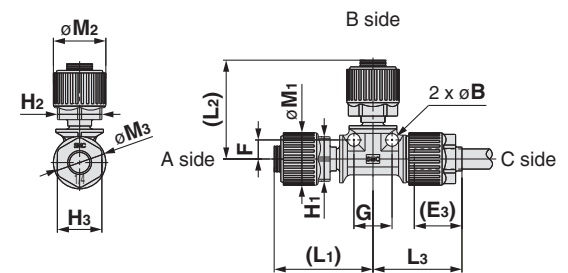

Class 2 to 5

Type T4

Metric Size

Model	A side	B side	C side	B	E ₁	E ₂	E ₃	F	G	H ₁	H ₂	H ₃	L ₁	L ₂	L ₃	M ₁	M ₂	M ₃
	Applicable tubing O.D.																	
LQ1T21-ST1-R39	ø6	Body size 3	ø6	5	20	—	20	9	18	17	17	17	36.5	41.1	36.5	23	23	23
LQ1T21-ST2-R41	Body size 3	ø6	ø6	—	—	20	—	—	—	—	—	—	41.1	36.5	—	—	—	—
LQ1T32-ST1-R37	ø8	Body size 3	ø8	5	20	—	20	9	18	17	17	17	36.5	41.1	36.5	23	23	23
LQ1T32-ST2-R40	Body size 3	ø8	ø8	—	—	20	—	—	—	—	—	—	41.1	36.5	—	—	—	—
* LQ1T41-ST1-R1	ø12	Body size 3	ø12	—	24	—	24	—	—	21	17	21	34	41.5	34	28	23	28
* LQ1T41-ST1-R37	ø12	Body size 5	ø12	—	24	—	24	—	—	21	26	21	39.5	52.5	39.5	28	39	28
* LQ1T51-ST1-R1	ø19	Body size 4	ø19	—	—	—	—	—	—	26	21	26	41.9	53	41.9	—	—	28
* LQ1T51-ST1-R2	ø19	Body size 3	ø19	—	29	—	29	—	—	26	17	26	41	48	41	39	23	39
LQ1T51-ST1-R5	ø12	Body size 5	ø19	7	—	—	—	14	28	—	26	—	54	59	54	—	—	39
* LQ1T51-ST1-R13	ø6	Body size 5	ø19	—	15	—	29	—	—	14	26	26	29	53	49	16.5	39	39
* LQ1T51-ST1-R36	ø12	Body size 6	ø19	—	24	—	39.5	—	—	36	36	36	42.7	71	58.2	49	49	49
* LQ1T51-ST1-R37	ø19	Body size 6	ø12	—	39.5	—	—	—	—	14	—	—	26	58.2	71	42.7	16.5	39
LQ1T51-ST2-R4	Body size 5	ø6	ø19	7	—	15	24	14	28	26	14	26	54	54	54	39	16.5	39
* LQ1T61-ST1-R1	ø25	Body size 5	ø25	—	39.5	—	39.5	—	—	36	—	26	58.2	63.5	—	—	—	39
* LQ1T61-ST1-R2	ø25	Body size 4	ø25	—	39.5	—	39.5	—	—	36	21	36	58.2	57	58.2	49	28	49
LQ1T61-ST2-R1	Body size 6	ø19	ø25	8	—	39.5	—	18	36	—	36	—	72	69.5	69.5	—	—	49

Inch Size

Model	A side	B side	C side	B	E ₁	E ₂	E ₃	F	G	H ₁	H ₂	H ₃	L ₁	L ₂	L ₃	M ₁	M ₂	M ₃
	Applicable tubing O.D.																	
LQ1T3A-ST2-R5	Body size 3	3/8	1/4	5	—	15	20	9	18	17	14	17	37.6	31.6	36.5	23	16.5	23
* LQ1T4A-ST1-R1	1/2	Body size 3	1/2	—	24	—	—	—	—	21	17	21	34	41.5	34	28	23	28
* LQ1T4A-ST1-R7	3/8	Body size 3	1/2	—	20	—	24	—	—	17	—	—	38.5	41.5	34	23	—	28
* LQ1T4A-ST1-R37	1/2	Body size 5	1/2	—	24	—	—	—	—	21	26	—	39.5	52.5	39.5	28	39	—
* LQ1T5A-ST1-R1	3/4	Body size 4	3/4	—	29	—	—	—	—	26	17	—	41.9	53	41.9	39	28	—
* LQ1T5A-ST1-R2	3/4	Body size 3	3/4	—	—	—	—	—	—	26	17	—	41	48	41	39	23	—
LQ1T5A-ST1-R5	1/2	Body size 5	3/4	7	15	—	29	14	28	—	26	—	38.5	55.5	—	16.5	39	—
LQ1T5A-ST1-R7	1/2	Body size 4	3/4	—	29	—	—	—	—	21	21	26	54	55.5	54	28	28	39
* LQ1T5A-ST1-R12	1/4	Body size 5	3/4	—	—	—	—	—	—	14	—	—	29	53	49	16.5	—	—
* LQ1T5A-ST2-R1	Body size 4	3/4	3/4	—	—	29	—	—	—	21	—	26	50.5	51.5	52.5	28	39	—
LQ1T5A-ST2-R3	Body size 5	1/4	3/4	7	—	15	29	14	28	26	14	—	59	38	54	39	16.5	—
* LQ1T5A-ST3-R5	Body size 4	3/4	Body size 4	—	—	29	—	—	—	21	26	21	50.5	44.5	50.5	28	39	28
* LQ1T6A-ST1-R1	1	Body size 5	1	—	39.5	—	—	—	—	36	—	26	58.2	63.5	—	—	—	39
* LQ1T6A-ST1-R2	1	Body size 4	1	—	39.5	—	—	—	—	36	21	36	58.2	57	58.2	49	28	—
* LQ1T6A-ST1-R3	1	Body size 3	1	—	—	—	39.5	—	—	36	17	36	52	—	—	49	23	49
LQ1T6A-ST2-R1	Body size 6	3/4	1	8	—	39.5	—	18	36	—	36	—	75.5	69.5	69.5	—	—	49
LQ1T6A-ST2-R2	Body size 6	3/4	3/4	—	—	—	—	—	—	—	—	—	—	—	—	—	—	—

Note) Products marked "*" are produced upon receipt of order.

Tubing Extension Union Elbow

How to Order

Tubing connection LQ1 E 21 - T - []

Fitting type

Symbol	Type
E	Union elbow

Packaging

Symbol	Packaging
—	Clean packaging equivalent to Class M3.5
1	Standard packaging equivalent to Class M5.5

Piping type

Symbol	Type
T	Tubing extension

Size combination

Symbol		Applicable tubing size (mm)
Class	No.	
2	1	6 x 4
3	1	10 x 8
3	2	8 x 6
4	1	12 x 10
5	1	19 x 16
6	1	25 x 22

Symbol		Applicable tubing size (inch)
Class	No.	
2	A	1/4" x 5/32"
3	A	3/8" x 1/4"
4	A	1/2" x 3/8"
5	A	3/4" x 5/8"
6	A	1" x 7/8"

Note) For details of the applicable tubing sizes, refer to page 72.

Dimensions

Tubing extension union elbow: LQ1E-T

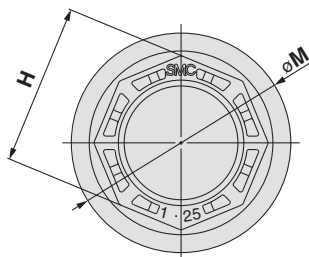

Class 6

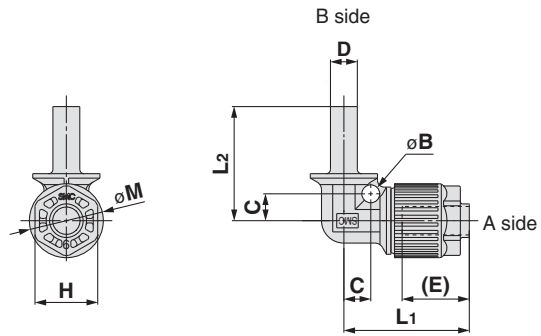

Class 2 to 5

Metric Size

Model	A side	B side	B	C	E	H	L ₁	L ₂	M
	Applicable tubing O.D.	Tubing size (D)							
LQ1E21-T	ø6	6 x 4	4	6	15	14	28	28.5	16.5
LQ1E31-T	ø10	10 x 8	5	9	20	17	36.6	37.6	23
LQ1E32-T	ø8	8 x 6	—	—	—	—	—	—	—
LQ1E41-T	ø12	12 x 10	6	9	24	21	43	43	28
* LQ1E51-T	ø19	19 x 16	—	—	29	26	45.5	55.5	39
LQ1E61-T	ø25	25 x 22	8	18	39.5	36	69.5	72	49

Note) Products marked "*" are produced upon receipt of order.

Inch Size

Model	A side	B side	B	C	E	H	L ₁	L ₂	M
	Applicable tubing O.D.	Tubing size (D)							
LQ1E2A-T	1/4"	1/4" x 5/32"	4	6	15	14	28	28.5	16.5
LQ1E3A-T	3/8"	3/8" x 1/4"	5	9	20	17	36.6	37.6	23
LQ1E4A-T	1/2"	1/2" x 3/8"	6	9	24	21	43	43	28
* LQ1E5A-T	3/4"	3/4" x 5/8"	—	—	29	26	45.5	55.5	39
LQ1E6A-T	1"	1" x 7/8"	8	18	39.5	36	69.5	72	49

Note) Products marked "*" are produced upon receipt of order.

Series LQ1

Tubing Extension Union Tee

How to Order

Tubing connection

LQ1 T 21 - T T1 -

Fitting type

Symbol	Type
T	Union tee

Size combination

Symbol	Applicable tubing size (inch)
2 A	1/4" x 5/32"
3 A	3/8" x 1/4"
4 A	1/2" x 3/8"
5 A	3/4" x 5/8"
6 A	1" x 7/8"

Packaging

Symbol	Packaging
—	Clean packaging equivalent to Class M3.5
1	Standard packaging equivalent to Class M5.5

Fitting type

Symbol	Type
T1	Type 1
T2	Type 2
T3	Type 3
T4	Type 4

Piping type

Symbol	Type
T	Tubing extension

Class	No.	Applicable tubing size (mm)
2	1	6 x 4
3	1	10 x 8
3	2	8 x 6
4	1	12 x 10
5	1	19 x 16
6	1	25 x 22

Note) For details of the applicable tubing sizes, refer to page 72.

Note) For details of the applicable tubing sizes, refer to page 72.

Dimensions

Tubing extension union tee: LQ1T-TT

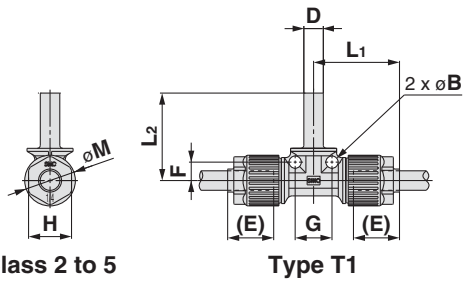

Class 2 to 5

Type T1

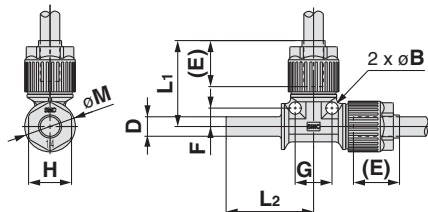

Class 2 to 5

Type T2

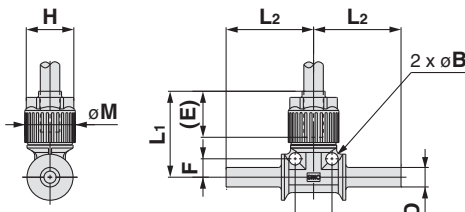

Class 2 to 5

Type T3

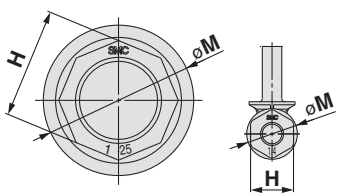

Class 6

Class 2 to 5

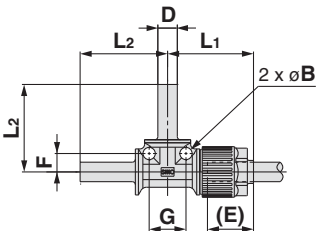

Type T4

Metric Size

Model	Applicable tubing O.D.	B	E	F	G	H	L ₁	L ₂	M	D
* LQ1T21-TT1	ø6	—	15	—	—	14	21.5	26.5	16.5	6.35 x 3.95
* LQ1T21-TT2							25.5	26.5		
* LQ1T31-TT1	ø10	—	20	—	—	17	30.6	35.5	23	10 x 8
* LQ1T31-TT2							34.5	35.5		
* LQ1T32-TT1	ø8	—	20	—	—	17	29.6	35.5	23	9.53 x 6.35
* LQ1T32-TT2							34.5			
* LQ1T32-TT3	ø12	—	24	—	—	21	36	42	28	12.7 x 9.5
* LQ1T41-TT1							41.5	41		
* LQ1T41-TT2	ø19	7	29	14	28	26	54	55.5	39	19.05 x 16
* LQ1T41-TT3										
LQ1T51-TT1	ø25	8	39.5	18	36	36	69.5	72	49	25.4 x 22.5
LQ1T51-TT2										
LQ1T51-TT3										
LQ1T51-TT4										
LQ1T61-TT1	ø25	8	39.5	18	36	36	69.5	72	49	25.4 x 22.5
LQ1T61-TT2										
LQ1T61-TT3										
LQ1T61-TT4										

Inch Size

Model	Applicable tubing O.D.	B	E	F	G	H	L ₁	L ₂	M	D
LQ1T2A-TT1	1/4"	4	15	6	12	14	28	28.5	16.5	1/4" x 5/32"
LQ1T2A-TT2										
LQ1T2A-TT3										
LQ1T2A-TT4										
LQ1T3A-TT1	3/8"	5	20	9	18	17	36.5	37.6	23	3/8" x 1/4"
LQ1T3A-TT2										
LQ1T3A-TT3										
LQ1T3A-TT4										
LQ1T4A-TT1	1/2"	6	24	9	18	21	43	43	28	1/2" x 3/8"
LQ1T4A-TT2										
LQ1T4A-TT3										
LQ1T4A-TT4										
LQ1T5A-TT1	3/4"	7	29	14	28	26	54	55.5	39	3/4" x 5/8"
LQ1T5A-TT2										
LQ1T5A-TT3										
LQ1T5A-TT4										
LQ1T6A-TT1	1"	8	39.5	18	36	36	69.5	72	49	1" x 7/8"
LQ1T6A-TT2										
LQ1T6A-TT3										
LQ1T6A-TT4										

Note) Products marked "*" are produced upon receipt of order.

Series LQ1 Tubing Extension Union Elbow Reducing

How to Order

Size combination (Metric)

Class	Model	A side	B side
		Applicable tubing size (mm)	Tubing size (mm)
2	LQ1E21-T-R8	6 x 4	8 x 6
	LQ1E21-T-R9		10 x 8
	LQ1E21-T-R10		12 x 10
	LQ1E22-T-R8	4 x 3	6 x 4
	LQ1E22-T-R9		8 x 6
	LQ1E22-T-R10		10 x 8
	LQ1E22-T-R11		12 x 10
3	LQ1E31-T-R1	10 x 8	6 x 4
	LQ1E31-T-R2		8 x 6
	LQ1E31-T-R8	12 x 10	
	* LQ1E31-T-R9	8 x 6	19 x 16
	LQ1E32-T-R1		6 x 4
	LQ1E32-T-R8		10 x 8
	LQ1E32-T-R9	12 x 10	
* LQ1E32-T-R10	19 x 16		
4	LQ1E41-T-R1	12 x 10	10 x 8
	LQ1E41-T-R2		8 x 6
	LQ1E41-T-R3		6 x 4
	* LQ1E41-T-R8	19 x 16	
	* LQ1E41-T-R9	25 x 22	
5	* LQ1E51-T-R8	19 x 16	25 x 22
6	LQ1E61-T-R1	25 x 22	19 x 16

Note 1) Products marked "*" are produced upon receipt of order.
Note 2) For details of the applicable tubing sizes, refer to page 72.

Dimensions

Tubing extension union elbow reducing: LQ1E-T-R

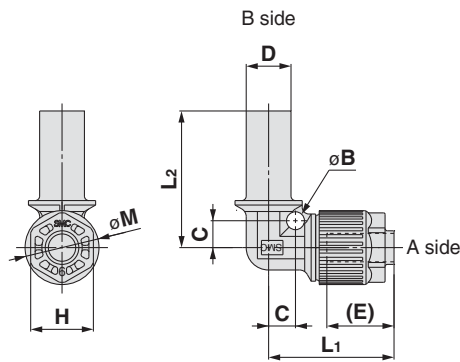

Class 2 to 5

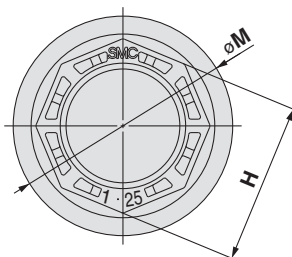

Class 6

Note) Products marked "*" are produced upon receipt of order.

Tubing connection

LQ1 E 2 1 - T - R8 -

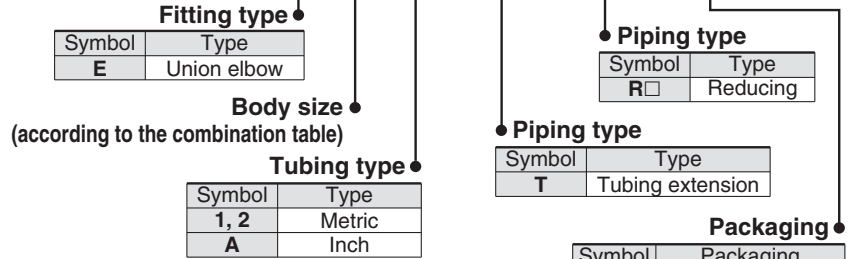

Size combination (Inch)

Class	Model	A side	B side
		Applicable tubing size (inch)	Tubing size (inch)
2	* LQ1E2A-T-R8	1/4" x 5/32"	3/8" x 1/4"
	* LQ1E2A-T-R9		1/2" x 3/8"
3	* LQ1E3A-T-R1	3/8" x 1/4"	1/4" x 5/32"
	* LQ1E3A-T-R8		1/2" x 3/8"
	* LQ1E3A-T-R9		3/4" x 5/8"
4	* LQ1E4A-T-R1	1/2" x 3/8"	3/8" x 1/2"
	* LQ1E4A-T-R8		3/4" x 5/8"
	* LQ1E4A-T-R9		1" x 7/8"
5	* LQ1E5A-T-R8	3/4" x 5/8"	1" x 7/8"
6	LQ1E6A-T-R1	1" x 7/8"	3/4" x 5/8"

Note 1) Products marked "*" are produced upon receipt of order.
Note 2) For details of the applicable tubing sizes, refer to page 72.

Metric Size

Model	A side	B side	B	C	D	E	H	L ₁	L ₂	M
	Applicable tubing O.D.	Tubing size (D)								
LQ1E21-T-R8	ø6	8 x 6	4	6	8	15	14	28	34.5	16.5
LQ1E21-T-R9		10 x 8			10				34.5	
LQ1E21-T-R10		12 x 10			12				38.5	
LQ1E22-T-R8	ø4	6 x 4			8				28.5	
LQ1E22-T-R9		8 x 6			8				34.5	
LQ1E22-T-R10		10 x 8			10				34.5	
LQ1E22-T-R11		12 x 10			12				38.5	
LQ1E31-T-R1	ø10	6 x 4	5	9	8	20	17	36.6	37.6	23
LQ1E31-T-R2		8 x 6			6				31.6	
LQ1E31-T-R8		12 x 10			12				41.6	
* LQ1E31-T-R9	ø8	19 x 16	5	9	19	20	17	36.6	46.5	23
LQ1E32-T-R1		6 x 4			6				31.6	
LQ1E32-T-R8		10 x 8			10				37.6	
LQ1E32-T-R9	12 x 10	12	41.6							
* LQ1E32-T-R10	19 x 16	19	46.5							
LQ1E41-T-R1	ø12	10 x 8	6	9	10	24	21	43	39	28
LQ1E41-T-R2		8 x 6			8				39	
LQ1E41-T-R3		6 x 4			6				33	
* LQ1E41-T-R8	ø19	19 x 16	6	9	19	24	21	41	39.6	28
* LQ1E41-T-R9		25 x 22			25				41	
* LQ1E41-T-R9		25 x 22			25				60	
* LQ1E51-T-R8	ø25	25 x 22	8	18	25	29	26	48.5	66.5	39
LQ1E61-T-R1		19 x 16			19				39.5	

Inch Size

Model	A side	B side	B	C	D	E	H	L ₁	L ₂	M
	Applicable tubing O.D.	Tubing size (D)								
* LQ1E2A-T-R8	1/4"	3/8" x 1/4"	—	—	3/8"	15	14	23.5	32.3	16.5
* LQ1E2A-T-R9		1/2" x 3/8"			1/2"				36.3	
* LQ1E3A-T-R1	3/8"	1/4" x 5/32"	—	—	1/4"	20	17	30.4	29.5	23
* LQ1E3A-T-R8		1/2" x 3/8"			1/2"				39.5	
* LQ1E3A-T-R9		3/4" x 5/8"			3/4"				46.5	
* LQ1E4A-T-R1	1/2"	3/8" x 1/4"	—	—	3/8"	24	21	34.8	38	28
* LQ1E4A-T-R8		3/4" x 5/8"			3/4"				49	
* LQ1E4A-T-R9		1" x 7/8"			1"				60	
* LQ1E5A-T-R8	3/4"	1" x 7/8"	—	—	1"	29	26	48.5	66.5	39
LQ1E6A-T-R1		3/4" x 5/8"			3/4"				39.5	

Series LQ1 Tubing Extension Union Tee Reducing

How to Order

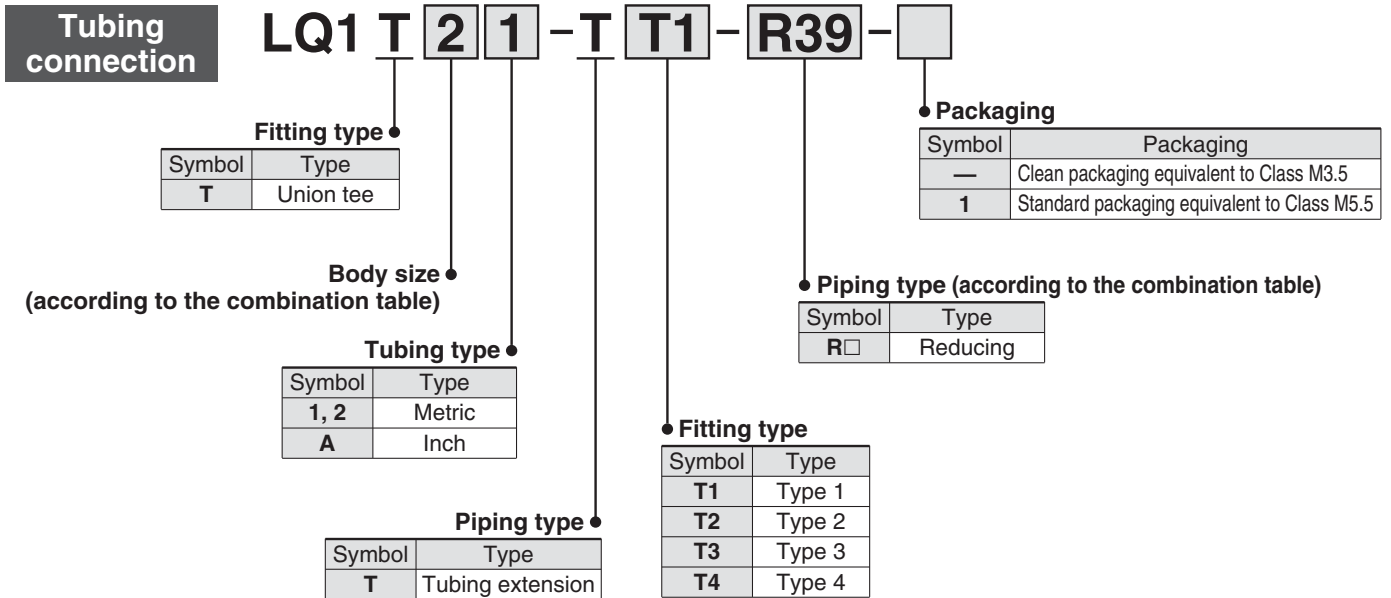

Size combination (Metric)

Class	Model	A side	B side	C side
		Applicable tubing size (O.D. x I.D.) / Tubing extensions (O.D. x I.D.)		
2	* LQ1T21-TT1-R39	6 x 4	Tube 10 x 8	6 x 4
	* LQ1T21-TT2-R41	Tube 10 x 8	6 x 4	
3	* LQ1T32-TT1-R37	8 x 6	Tube 10 x 8	8 x 6
	* LQ1T32-TT2-R40	Tube 10 x 8	8 x 6	
4	* LQ1T41-TT1-R1	12 x 10	Tube 10 x 8	12 x 10
	* LQ1T41-TT1-R37		Tube 19 x 16	
5	* LQ1T51-TT1-R1	19 x 16	Tube 12 x 10	19 x 16
	* LQ1T51-TT1-R2		Tube 10 x 8	
	* LQ1T51-TT1-R5	12 x 10	Tube 19 x 16	
	* LQ1T51-TT1-R13	6 x 4		
	* LQ1T51-TT1-R37	19 x 16	Tube 25 x 22	
	* LQ1T51-TT1-R38	6 x 4		
	* LQ1T51-TT2-R4	Tube 19 x 16		
6	* LQ1T61-TT1-R1	25 x 22	Tube 19 x 16	25 x 22
	* LQ1T61-TT1-R2		Tube 1/2" x 3/8"	
	* LQ1T61-TT2-R1	Tube 25 x 22	19 x 16	

Note 1) Products marked "*" are produced upon receipt of order.

Note 2) For details of the applicable tubing sizes, refer to page 72.

Size combination (Inch)

Class	Model	A side	B side	C side
		Applicable tubing size (O.D. x I.D.) / Tubing extensions (O.D. x I.D.)		
3	LQ1T3A-TT2-R5	Tube 3/8" x 1/4"	3/8" x 1/4"	1/4" x 5/32"
4	* LQ1T4A-TT1-R1	1/2" x 3/8"	Tube 3/8" x 1/4"	1/2" x 3/8"
	* LQ1T4A-TT1-R7	3/8" x 1/4"		
5	* LQ1T4A-TT1-R37	1/2" x 3/8"	Tube 3/4" x 5/8"	3/4" x 5/8"
	* LQ1T5A-TT1-R1	3/4" x 5/8"	Tube 1/2" x 3/8"	
	* LQ1T5A-TT1-R2		Tube 3/8" x 1/4"	
	* LQ1T5A-TT1-R3	1/4" x 5/32"	Tube 3/4" x 5/8"	
	* LQ1T5A-TT1-R5	1/2" x 3/8"	Tube 1/2" x 3/8"	
	* LQ1T5A-TT2-R4	Tube 3/4" x 5/8"	1/4" x 5/32"	
	* LQ1T5A-TT2-R40	Tube 1" x 7/8"	3/4" x 5/8"	
* LQ1T5A-TT3-R5	Tube 3/4" x 5/8"	Tube 1/2" x 3/8"		
* LQ1T5A-TT3-R7	Tube 1/2" x 3/8"			
6	* LQ1T6A-TT1-R1	1" x 7/8"	Tube 3/4" x 5/8"	1" x 7/8"
	* LQ1T6A-TT1-R2		Tube 1/2" x 3/8"	
	* LQ1T6A-TT1-R3		Tube 3/8" x 1/4"	
	* LQ1T6A-TT2-R1		Tube 3/4" x 5/8"	

Note 1) Products marked "*" are produced upon receipt of order.

Note 2) For details of the applicable tubing sizes, refer to page 72.

Dimensions

Tubing extension union tee reducing: LQ1T-T-R

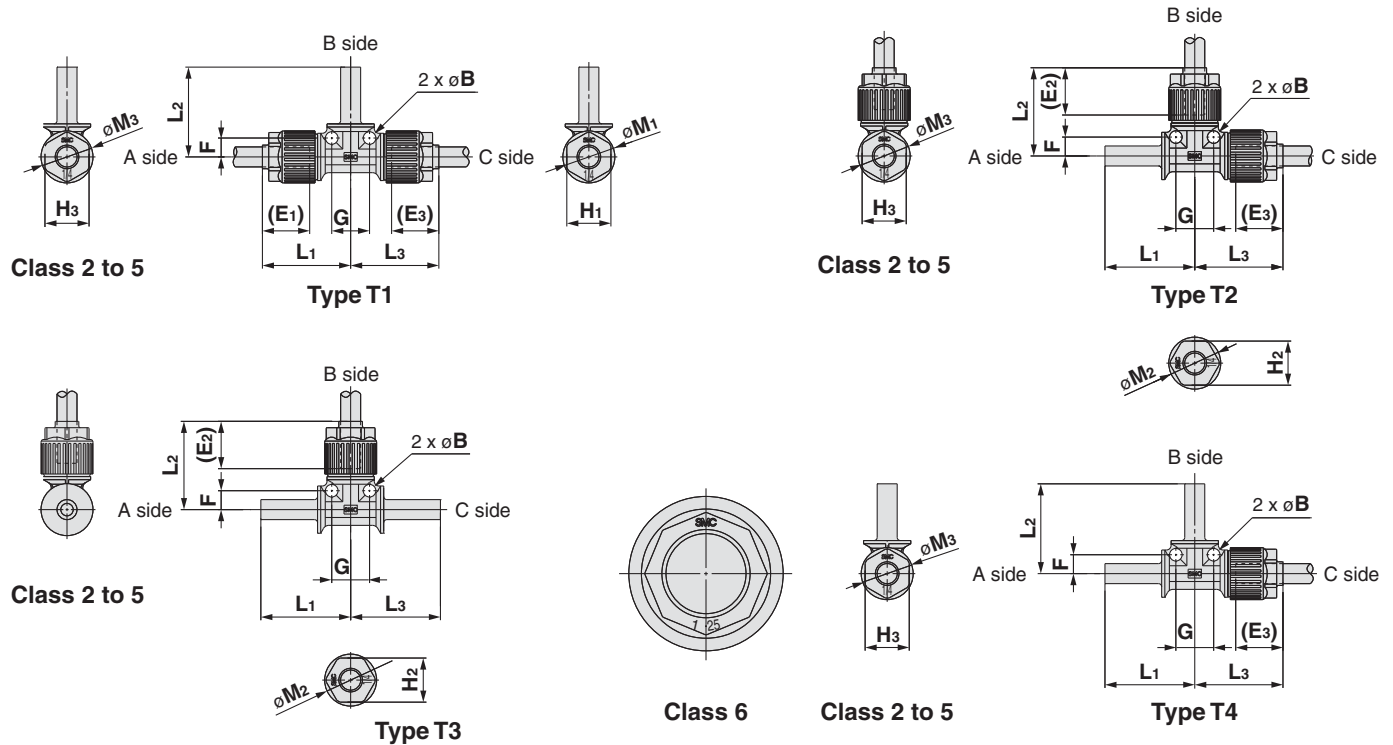

Metric Size

Model	A side	B side	C side	B	E ₁	E ₂	E ₃	F	G	H ₁	H ₂	H ₃	L ₁	L ₂	L ₃	M ₁	M ₂	M ₃
	Applicable tubing O.D.																	
* LQ1T21-TT1-R39	ø6	Tube ø10	ø6	—	20	—	20	—	—	17	—	17	29	35.5	29	23	—	23
* LQ1T21-TT2-R41	Tube ø10	ø6	ø6	—	—	20	—	—	—	17	—	17	35.5	34.5	—	—	23	—
* LQ1T32-TT1-R37	ø8	Tube ø10	ø8	—	20	—	20	—	—	17	—	17	29	35.5	29	23	—	23
* LQ1T32-TT2-R40	Tube ø10	ø8	ø8	—	—	20	—	—	—	17	—	17	35.5	34.5	—	—	23	—
* LQ1T41-TT1-R1	ø12	Tube ø10	ø12	—	24	—	24	—	—	21	—	21	35	38	35	28	—	28
* LQ1T41-TT1-R37	ø12	Tube ø19	ø12	—	24	—	24	—	—	21	—	21	39.5	49	39.5	—	—	—
* LQ1T51-TT1-R1	ø19	Tube ø12	ø19	—	—	—	—	—	—	—	—	—	41.5	47.5	41.5	—	—	—
* LQ1T51-TT1-R2	ø19	Tube ø10	ø19	—	29	—	29	—	—	26	—	26	41	44.5	41	39	—	39
LQ1T51-TT1-R5	ø12	Tube ø19	ø19	7	—	—	—	—	14	28	—	—	54	55.5	54	—	—	—
* LQ1T51-TT1-R13	ø6	Tube ø19	ø19	—	15	—	29	—	—	14	—	26	29	54.5	45	16.5	—	39
LQ1T51-TT1-R37	ø19	Tube ø25	ø19	8	39.5	—	39.5	18	36	36	—	36	69.5	49	69.5	49	—	49
* LQ1T51-TT1-R38	ø6	Tube ø25	ø19	—	15	—	29	—	—	14	—	26	32.2	64	48.2	16.5	—	39
LQ1T51-TT2-R4	Tube ø19	ø6	ø19	7	—	15	29	14	28	—	14	26	55.5	38	54	—	16.5	39
* LQ1T61-TT1-R1	ø25	Tube ø19	ø25	—	39.5	—	39.5	—	—	36	—	26	55.1	59.5	55.1	49	—	49
* LQ1T61-TT1-R2	ø25	Tube 1/2	ø25	—	—	—	—	—	—	36	—	21	53.5	52.5	53.5	—	—	—
LQ1T61-TT2-R1	Tube ø25	ø19	ø25	8	—	39.5	—	18	36	—	36	36	72	69.5	69.5	—	49	—

Inch Size

Model	A side	B side	C side	B	E ₁	E ₂	E ₃	F	G	H ₁	H ₂	H ₃	L ₁	L ₂	L ₃	M ₁	M ₂	M ₃
	Applicable tubing O.D.																	
LQ1T3A-TT2-R5	Tube 3/8	3/8	1/4	5	—	20	15	9	18	—	17	14	37.6	36.5	31.6	—	23	16.5
* LQ1T4A-TT1-R1	1/2	Tube 3/8	1/2	—	24	—	24	—	—	21	—	21	34	38	34	28	—	28
* LQ1T4A-TT1-R7	3/8	Tube 3/8	1/2	—	20	—	24	—	—	17	—	21	34	38	34	23	—	28
* LQ1T4A-TT1-R37	1/2	Tube 3/4	1/2	—	24	—	24	—	—	21	—	21	39.5	49	39.5	28	—	28
* LQ1T5A-TT1-R1	3/4	Tube 1/2	3/4	—	29	—	29	—	—	26	—	26	41.9	47.5	41.9	39	—	39
* LQ1T5A-TT1-R2	3/4	Tube 3/8	3/4	—	29	—	29	—	—	26	—	26	41	44.5	41	39	—	39
* LQ1T5A-TT1-R3	1/4	Tube 3/4	3/4	—	15	—	29	—	—	14	—	26	29	54.5	49	16.5	—	39
LQ1T5A-TT1-R5	1/2	Tube 3/4	3/4	7	29	—	29	14	28	26	—	26	54	55.5	54	39	—	39
LQ1T5A-TT1-R7	1/2	Tube 1/2	3/4	7	29	—	29	14	28	26	—	26	54	48.5	54	39	—	39
LQ1T5A-TT2-R4	Tube 3/4	1/4	3/4	7	—	15	29	14	28	—	14	26	55.5	38	54	—	16.5	39
* LQ1T5A-TT2-R40	Tube 1	3/4	3/4	—	—	29	29	—	—	26	—	26	64	54	51.5	—	39	39
LQ1T5A-TT3-R5	Tube 3/4	3/4	Tube 1/2	7	—	29	—	14	28	—	26	—	48.5	54	55.5	—	39	—
* LQ1T5A-TT3-R7	Tube 1/2	3/4	Tube 1/2	—	—	29	—	—	—	26	—	26	46	44.5	46	—	39	—
* LQ1T6A-TT1-R1	ø25	Tube 3/4	ø25	—	39.5	—	39.5	—	—	36	—	36	55.1	59.5	55.1	49	—	49
* LQ1T6A-TT1-R2	ø25	Tube 1/2	ø25	—	—	—	—	—	—	36	—	36	53.5	52.5	53.5	—	—	—
* LQ1T6A-TT1-R3	ø25	Tube 3/8	ø25	—	—	—	—	—	—	36	—	36	53.5	48.5	53.5	—	—	—
LQ1T6A-TT2-R1	Tube 1	ø19	ø25	8	—	39.5	—	18	36	—	36	36	72	69.5	69.5	—	49	—

Note) Products marked "*" are produced upon receipt of order.

LQ1
LQ3
LVN
LQHB
TL/TIL
TD/TID
TH/THI
Applicable Fluid
Precautions



Series LQ1

How to Order Space Saving Type Fittings

This product, for use with products with one nut attached (insert bushing) has one nut removed.

LQ1 E 21 - SN -

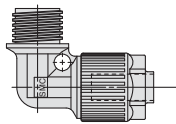
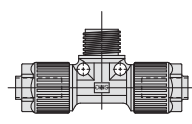
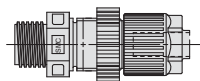
Fitting type

E	T
Union Elbow 	Union Tee 
P	U
Panel Mount Union 	Union 

Packaging

Symbol	Packaging
—	Clean packaging equivalent to Class M3.5
1	Standard packaging equivalent to Class M5.5

Without a nut (including insert bushing) in one part

Combination of different diameter (on B side)

Symbol	Applicable tubing size (mm)		Symbol	Applicable tubing size (inch)	
Size	No.		Size	No.	
1	1	4 x 3	1	A	1/8" x 0.086"
1	2	3 x 2	—	—	—
2	1	6 x 4	2	A	1/4" x 5/32"
2	2	4 x 3	2	B	3/16" x 1/8"
3	1	10 x 8	2	C	1/8" x 0.086"
3	2	8 x 6	3	A	3/8" x 1/4"
3	3	6 x 4	3	B	1/4" x 5/32"
4	1	12 x 10	4	A	1/2" x 3/8"
4	2	10 x 8	4	B	3/8" x 1/4"
5	1	19 x 16	5	A	3/4" x 5/8"
5	2	12 x 10	5	B	1/2" x 3/8"
6	1	25 x 22	6	A	1" x 7/8"
6	2	19 x 16	6	B	3/4" x 5/8"

Connection example

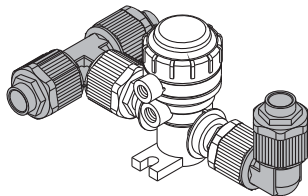

Note 1) For each body class, the second and later numbers or symbols indicate reducing. However, use of different diameters is not available with size 1.

Note 2) Please choose the same size fitting as the fitting of the connecting product.

Note 3) For details of applicable tubing sizes, refer to page 72.

Options

Panel mounting nut

LQN P 11 -

Applicable fitting

Symbol	Size
11	1
12	2
13	3
14	4
15	5
16	6

Packaging

Symbol	Packaging
—	Clean packaging equivalent to Class M3.5
1	Standard packaging equivalent to Class M5.5

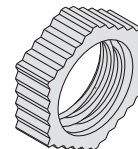

It is used to mount panels with a panel mount union.

Options

Nut insert bush

LQ 1 - 2 U 03 -

In cases where exchanging the tubing size, we recommend the U type.

Applicable fitting

Symbol	Applicable fitting
1	LQ1

Size

Symbol	Size
1	1
2	2
3	3
4	4
5	5
6	6

Type of part

Symbol	Type of part
U	Nut insert bush
B	Insert bush
N	Nut

Packaging

Symbol	Packaging
—	Clean packaging equivalent to Class M3.5
1	Standard packaging equivalent to Class M5.5

Applicable tubing size

Metric Size

Symbol	Applicable tubing size	Size					
		1	2	3	4	5	6
03	ø3 x ø2	○	○				
04	ø4 x ø3	○	○				
06	ø6 x ø4		○	○			
08	ø8 x ø6			○			
10	ø10 x ø8			○	○		
12	ø12 x ø10				○	○	
19	ø19 x ø16					○	○
25	ø25 x ø22.5						○

Inch Size

Symbol	Applicable tubing size	Size					
		1	2	3	4	5	6
03	1/8" x 0.086"	○	○				
05	3/16" x 1/8"		○				
07	1/4" x 5/32"		○	○			
11	3/8" x 1/4"			○	○		
13	1/2" x 3/8"				○	○	
19	3/4" x 5/8"					○	○
25	1" x 7/8"						○

Note 1) In the case of size 1, changing the tubing by reducing is not available.
Note 2) For details of applicable tubing sizes, refer to page 72.

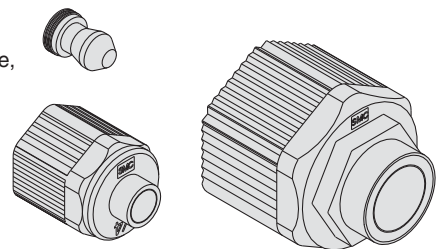

Blanking plug

LQ - 11 P 04 -

Applicable fitting

Symbol	Size
11	1
12	2
13	3
14	4
15	5
16	6

Packaging

Symbol	Packaging
—	Clean packaging equivalent to Class M3.5
1	Standard packaging equivalent to Class M5.5

Applicable tubing size

Metric Size

Symbol	Applicable tubing size	Size					
		1	2	3	4	5	6
03	ø3 x ø2	○	●				
04	ø4 x ø3	○	●				
06	ø6 x ø4		○	●			
08	ø8 x ø6			●			
10	ø10 x ø8			○	●		
12	ø12 x ø10				○	●	
19	ø19 x ø16					○	●
25	ø25 x ø22.5						○

Inch Size

Symbol	Applicable tubing size	Size					
		1	2	3	4	5	6
03	1/8" x 0.086"	○	●				
05	3/16" x 1/8"		●				
07	1/4" x 5/32"		○	●			
11	3/8" x 1/4"			○	●		
13	1/2" x 3/8"				○	●	
19	3/4" x 5/8"					○	●
25	1" x 7/8"						○

○ Basic size ● With reducer

Used to block fittings which are not being used.

Note) For details of the applicable tubing sizes, refer to page 72.

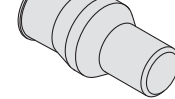

Tubing plug

LQ1 - 2 CP -

Tubing plug will be a made-to-order product.

Size

Symbol	Size
1	1
2	2
3	3
4	4
5	5
6	6

Size

Symbol	Size
—	Without an insert bush
1	With an insert bush

Applicable tubing size

Metric Size

Symbol	Applicable tubing size	Size
03	ø3 x ø2	1
04	ø4 x ø3	1
06	ø6 x ø4	2
08	ø8 x ø6	3
10	ø10 x ø8	3
12	ø12 x ø10	4
19	ø19 x ø16	5
25	ø25 x ø22	6

Inch Size

Symbol	Applicable tubing size	Size
03	1/8" x 0.086"	1
07	1/4" x 5/32"	2
11	3/8" x 1/4"	3
13	1/2" x 3/8"	4
19	3/4" x 5/8"	5
25	1" x 7/8"	6

Used to block fittings which are not being used.

Note) For details of the applicable tubing sizes, refer to page 72.

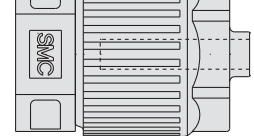

Series LQ1 Insertion Tool

Fittings

Changing tubing sizes

The tubing size can be changed within the same body class (body size) by replacing the nut and insert bushing. However, in case of class 1, the tubing cannot be changed by reducing.

Body class	Tubing O.D.														
	Metric sizes								Inch sizes						
	ø3	ø4	ø6	ø8	ø10	ø12	ø19	ø25	1/8"	3/16"	1/4"	3/8"	1/2"	3/4"	1"
1	○	○	—	—	—	—	—	—	○	—	—	—	—	—	—
2	●	●	○	—	—	—	—	—	●	●	○	—	—	—	—
3	—	—	●	●	○	—	—	—	—	—	●	○	—	—	—
4	—	—	—	—	●	○	—	—	—	—	—	●	○	—	—
5	—	—	—	—	—	●	○	—	—	—	—	—	●	○	—
6	—	—	—	—	—	—	●	○	—	—	—	—	—	●	○

Parts composition

	Component parts		
	Nut	Insert	Collar (Insert assembly)
○ Basic size	Yes	Yes	No
● Reducer type	Yes	Yes	Yes

⚠ Caution

1. Connect tubing with special tools

Refer to the pamphlet "High-Purity Fluoropolymer Fittings Hyper fitting/Series LQ1, 2 Work Procedure Instructions" (M-E05-1) for connecting tubing and special tools. (Downloadable from our web site.)

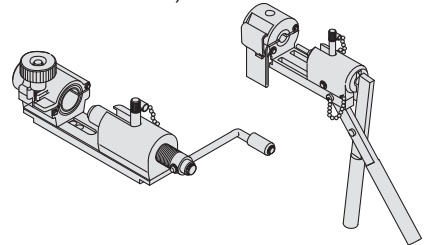

Changing the tubing size

Example) Changing the tubing from an O.D. 1/4" to O.D. 1/8" in LQ1 body class 2.

Prepare an insert bushing and nut for 1/8" O.D. tubing (LQ1-2U03) and change the tubing size. (Refer to the section on how to order fitting parts.)

Note) Tubing is sold separately.

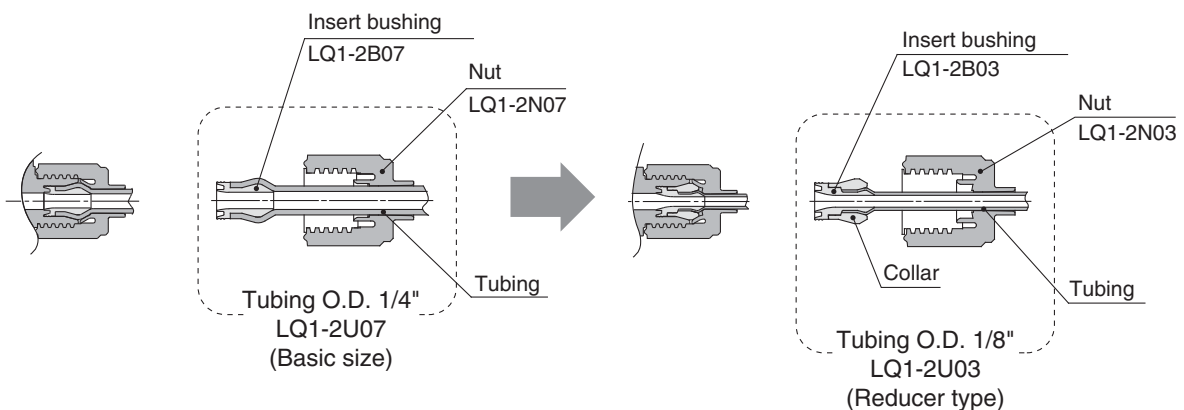

Precautions	Applicable Fluid	TH/THH	TD/TID	TL/TIL	LQHB	LVN	LQ3	LQ1
-------------	------------------	--------	--------	--------	------	-----	-----	-----

Fluoropolymer Fittings Hyper Fittings / Flare Type Series LQ3



How to Order

Threaded connection

LQ3 H 11 - M - -

• Fitting type

Symbol	Type
H	Connector
L	Elbow
B	Branch tee
R	Run tee

• Nut material, packaging

Symbol	Nut material	Packaging
—	PFA	Clean packaging equivalent to Class M3.5
1	PFA	Standard packaging equivalent to Class M5.5
2	PVDF	Clean packaging equivalent to Class M3.5
3	PVDF	Standard packaging equivalent to Class M5.5

• Thread type

Symbol	Type
—	R, Rc
N	NPT

• Piping type

Symbol	Type
M	Male
F	Female

• Size combination

Size	No.	Applicable tubing size (mm)	Port size
1	1	4 x 3	1/8"
1	2	3 x 2	
2	1	6 x 4	1/8"
2	2		1/4"
3	1	10 x 8	1/8"
3	2	8 x 6	
3	3	10 x 8	1/4"
3	4	8 x 6	
3	5	10 x 8	3/8"
3	6	8 x 6	
3	8		1/2"
4	1	12 x 10	1/4"
4	2		3/8"
4	3		1/2"
4	4		3/4"
5	1	19 x 16	3/8"
5	2		1/2"
5	3		3/4"
6	1	25 x 22	1/2"
6	2		3/4"
6	3		1"

Size	Symbol	Applicable tubing size (inch)	Port size
1	A	1/8" x 0.086"	1/8"
2	A	1/4" x 5/32"	1/8"
2	B		1/4"
3	A	3/8" x 1/4"	1/8"
3	B		1/4"
3	C		3/8"
3	D		1/2"
4	A	1/2" x 3/8"	1/4"
4	B		3/8"
4	C		1/2"
4	D		3/4"
5	A	3/4" x 5/8"	3/8"
5	B		1/2"
5	C		3/4"
6	A	1" x 7/8"	1/2"
6	B		3/4"
6	C		1"
7*	A*	1 1/4" x 1.1"	3/4"
7*	B*		1"
7*	C*		1 1/4"

* H: Connector only

Note) For details of the applicable tubing sizes, refer to page 72.

How to Order

Tubing connection

LQ3 E 11 -

Fitting type

Symbol	Type
E	Union elbow
T	Union tee
P	Panel mount union
U	Union

Nut material, packaging

Symbol	Nut material	Packaging
—	PFA	Clean packaging equivalent to Class M3.5
1	PFA	Standard packaging equivalent to Class M5.5
2	PVDF	Clean packaging equivalent to Class M3.5
3	PVDF	Standard packaging equivalent to Class M5.5

Size combination

Size	No.	Applicable tubing size (mm)
1	1	4 x 3
1	2	3 x 2
2	1	6 x 4
3	1	10 x 8
3	2	8 x 6
4	1	12 x 10
5	1	19 x 16
6	1	25 x 22

Size	Symbol	Applicable tubing size (inch)
1	A	1/8" x 0.086"
2	A	1/4" x 5/32"
3	A	3/8" x 1/4"
4	A	1/2" x 3/8"
5	A	3/4" x 5/8"
6	A	1" x 7/8"
7*	A*	1 1/4" x 1.1"

* E: Union Elbow and U: Union only

Note) For details of the applicable tubing sizes, refer to page 72.

LQ1

LQ3

LVN

LQHB

TL/TIL

TD/TID

TH/TIH

Applicable Fluid

Precautions

Dimensions

Male connector: LQ3H-M

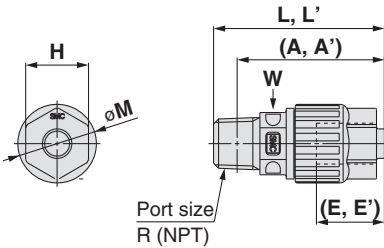

(A,A'): Reference dimension after installation
 (E,E'): Reference dimension for the inserted tubing from the end surface of the nut
 (A'),L',E': Nut material PVDF dimensions
 W: Width across flats dimension

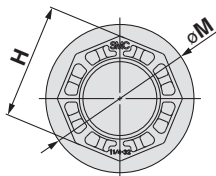

Class 7

Metric Size

Model	Applicable tubing O.D.	Connection threads R/NPT	A	A'	E	E'	H	L	L'	M	W
LQ3H11-M□	ø4	1/8"	29.5	28.5	10	9	11	33.5	32.5	14	10
LQ3H12-M□	ø3										
LQ3H21-M□	ø6	1/8"	39.5	38.5	17	16	16	43.5	42.5	20	14
LQ3H22-M□		1/4"	37.5	36.5							
LQ3H31-M□	ø10	1/8"	51	48	22.5	19.5	21	55	52	25	18
LQ3H32-M□	ø8										
LQ3H33-M□	ø10	1/4"	49	46	22.5	19.5	21	55	52	25	18
LQ3H34-M□	ø8										
LQ3H35-M□	ø10	3/8"	48.5	45.5	22.5	19.5	21	55	52	25	18
LQ3H36-M□	ø8										
LQ3H38-M□	ø12	1/2"	54	51	24	22	24	62	59	29	22
LQ3H41-M□		1/4"	58	56				64	62		
LQ3H42-M□	ø12	3/8"	57.5	55.5	24	22	24	64	62	29	22
LQ3H43-M□		1/2"	56	54							
LQ3H44-M□	ø19	3/4"	59.8	57.6	26.5	24	32	69.3	67.1	37	30
LQ3H51-M□		3/8"	69.5	67				76	73.5		
LQ3H52-M□	ø19	1/2"	68	65.5	26.5	24	32	76	73.5	37	30
LQ3H53-M□		3/4"	66.5	64							
LQ3H61-M□	ø25	1/2"	80	76	30	26	41	88	84	49	36
LQ3H62-M□		3/4"	78.5	74.5							
LQ3H63-M□	ø25	1"	77.5	73.5	30	26	41	88	84	49	36
LQ3H63-M□		1"	77.5	73.5							

Inch Size

Model	Applicable tubing O.D.	Connection threads R/NPT	A	A'	E	E'	H	L	L'	M	W
LQ3H1A-M□	1/8"	1/8"	29.5	28.5	10	9	11	33.5	32.5	14	10
LQ3H2A-M□	1/4"	1/8"	39.5	38.5	17	16	16	43.5	42.5	20	14
LQ3H2B-M□		1/4"	37.5	36.5							
LQ3H3A-M□	3/8"	1/8"	51	48	22.5	19.5	21	55	52	25	18
LQ3H3B-M□		1/4"	49	46							
LQ3H3C-M□		3/8"	48.5	45.5							
LQ3H3D-M□		1/2"	54	51							
LQ3H4A-M□	1/2"	1/4"	58	56	24.5	22.5	24	64	62	29	22
LQ3H4B-M□		3/8"	57.5	55.5							
LQ3H4C-M□		1/2"	56	54							
LQ3H4D-M□		3/4"	59.8	57.6							
LQ3H5A-M□	3/4"	3/8"	69.5	67	26.5	24	32	76	73.5	37	30
LQ3H5B-M□		1/2"	68	65.5							
LQ3H5C-M□		3/4"	66.5	64							
LQ3H6A-M□	1"	1/2"	80	76	30	26	41	88	84	49	36
LQ3H6B-M□		3/4"	78.5	74.5							
LQ3H6C-M□		1"	77.5	73.5							
LQ3H7A-M□	1 1/4"	3/4"	96.5	96.5	35	35	50	106	106	64	46
LQ3H7B-M□		1"	95.5	95.5							
LQ3H7C-M□		1 1/4"	93.3	93.3							

LQ1

LQ3

LVN

LQHB

TL/TIL

TD/TID

TH/THH

Applicable Fluid

Precautions

Series LQ3

Dimensions

Female connector: LQ3H-F

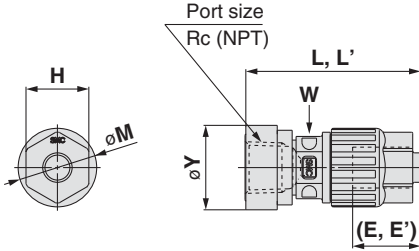

(E,E'): Reference dimension for the inserted tubing from the end surface of the nut
 (E'),L': Nut material PVDF dimensions
 W: Width across flats dimension

Metric Size

Model	Applicable tubing O.D.	Connection threads Rc/NPT	E	E'	H	L	L'	M	W	Y
LQ3H11-F□	ø4	1/8"	10	9	11	35	34	14	10	18.5
LQ3H12-F□	ø3									
LQ3H21-F□	ø6	1/8"	17	16	16	40	39	20	14	18.5
LQ3H22-F□		1/4"				45	44			21.5
LQ3H31-F□	ø10	1/8"	22.5	19.5	21	50.5	47.5	25	18	18.5
LQ3H32-F□	ø8									
LQ3H33-F□	ø10	1/4"	22.5	19.5	21	55	52	25	18	21.5
LQ3H34-F□	ø8									
LQ3H35-F□	ø10	3/8"	22.5	19.5	21	55.5	52.5	25	18	25
LQ3H36-F□	ø8									
LQ3H41-F□	ø12	1/4"	24	22	24	55.5	53	29	22	21.5
LQ3H42-F□		3/8"				58	56			25
LQ3H43-F□		1/2"				66	64			29.5
LQ3H51-F□	ø19	3/8"	26.5	24	32	67	64.5	37	30	25
LQ3H52-F□		1/2"				72	69.5			29.5
LQ3H53-F□		3/4"				73.5	71			36
LQ3H61-F□	ø25	1/2"	30	26	41	81.5	77.5	49	36	29.5
LQ3H62-F□		3/4"				83	79			36
LQ3H63-F□		1"				90.5	86.5			44.5

Inch Size

Model	Applicable tubing O.D.	Connection threads Rc/NPT	E	E'	H	L	L'	M	W	Y
LQ3H1A-F□	1/8"	1/8"	10	9	11	35	34	14	10	18.5
LQ3H2A-F□	1/4"	1/8"	17	16	16	40	39	20	14	18.5
LQ3H2B-F□		1/4"				45	44			21.5
LQ3H3A-F□	3/8"	1/8"	22.5	19.5	21	50.5	47.5	25	18	18.5
LQ3H3B-F□		1/4"				55	52			21.5
LQ3H3C-F□		3/8"				55.5	52.5			25
LQ3H4A-F□	1/2"	1/4"	24.5	22.5	24	55.5	53	29	22	21.5
LQ3H4B-F□		3/8"				58	56			25
LQ3H4C-F□		1/2"				66	64			29.5
LQ3H5A-F□	3/4"	3/8"	26.5	24	32	67	64.5	37	30	25
LQ3H5B-F□		1/2"				72	69.5			29.5
LQ3H5C-F□		3/4"				73.5	71			36
LQ3H6A-F□	1"	1/2"	30	26	41	81.5	77.5	49	36	29.5
LQ3H6B-F□		3/4"				83	79			36
LQ3H6C-F□		1"				90.5	86.5			44.5

Dimensions

Male elbow: LQ3L-M

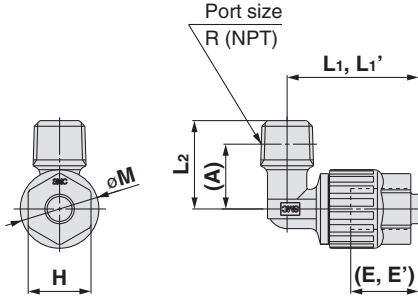

(A): Reference dimension after installation
(E,E'): Reference dimension for the inserted tubing from the end surface of the nut
(E'),L1': Nut material PVDF dimensions

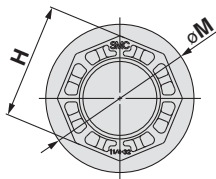

Class 7

Metric Size

Model	Applicable tubing O.D.	Connection threads R/NPT	A	E	E'	H	L ₁	L ₁ '	L ₂	M
LQ3L11-M□	ø4	1/8"	12.5	10	9	11	26	25	16.5	14
LQ3L12-M□	ø3		18.5	17	16	16	33.5	32.5	22.5	20
LQ3L21-M□	ø6	1/8"	18.5	17	16	16	33.5	32.5	22.5	20
LQ3L22-M□		1/4"	16.5							
LQ3L31-M□	ø10	1/8"	24	22.5	19.5	21	46	43	28	25
LQ3L32-M□	ø8	1/4"	22							
LQ3L33-M□	ø10		3/8"	21.5	26.5	24	32	64	61.5	40
LQ3L34-M□	ø8	22								
LQ3L35-M□	ø10	1/2"	24.5	26.5	24	32	64	61.5	40	37
LQ3L36-M□	ø8		21.5							
LQ3L38-M□	ø8	1/2"	24.5	30	26	41	77	73	46	49
LQ3L41-M□	ø12	1/4"	27							
LQ3L42-M□	ø12	3/8"	26.5	24.5	22.5	24	54.5	52.5	33	29
LQ3L43-M□		1/2"	25							
LQ3L51-M□	ø19	3/8"	33.5	26.5	24	32	64	61.5	40	37
LQ3L52-M□		1/2"	32							
LQ3L53-M□	ø19	3/4"	30.5	30	26	41	77	73	46	49
LQ3L61-M□	ø25	1/2"	38							
LQ3L62-M□	ø25	3/4"	36.5	30	26	41	77	73	46	49
LQ3L63-M□		1"	35.5							

Inch Size

Model	Applicable tubing O.D.	Connection threads R/NPT	A	E	E'	H	L ₁	L ₁ '	L ₂	M
LQ3L1A-M□	1/8"	1/8"	12.5	10	9	11	26	25	16.5	14
LQ3L2A-M□	1/4"	1/8"	18.5	17	16	16	33.5	32.5	22.5	20
LQ3L2B-M□		1/4"	16.5							
LQ3L3A-M□	3/8"	1/8"	24	22.5	19.5	21	46	43	28	25
LQ3L3B-M□		1/4"	22							
LQ3L3C-M□		3/8"	21.5							
LQ3L3D-M□		1/2"	24.5							
LQ3L4A-M□	1/2"	1/4"	27	24.5	22.5	24	54.5	52.5	33	29
LQ3L4B-M□		3/8"	26.5							
LQ3L4C-M□		1/2"	25							
LQ3L5A-M□	3/4"	3/8"	33.5	26.5	24	32	64	61.5	40	37
LQ3L5B-M□		1/2"	32							
LQ3L5C-M□		3/4"	30.5							
LQ3L6A-M□	1"	1/2"	38	30	26	41	77	73	46	49
LQ3L6B-M□		3/4"	36.5							
LQ3L6C-M□		1"	35.5							

LQ1

LQ3

LVN

LQHB

TL/TIL

TD/TID

TH/THH

Applicable Fluid

Precautions

Series LQ3

Dimensions

Female elbow: LQ3L-F

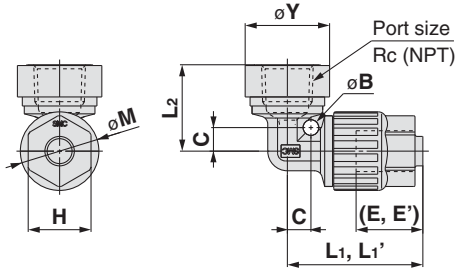

(E,E'): Reference dimension for the inserted tubing from the end surface of the nut
(E'),L1': Nut material PVDF dimensions

Metric Size

Model	Applicable tubing O.D.	Connection threads Rc/NPT	B	C	E	E'	H	L ₁	L ₁ '	L ₂	M	Y
LQ3L11-F□	ø4	1/8"	3.5	4.8	10	9	11	28.5	27.5	19.5	14	18.5
LQ3L12-F□	ø3											
LQ3L21-F□	ø6	1/8"	4	6	17	16	16	34.5	33.5	20	20	18.5
LQ3L22-F□		1/4"								22		21.5
LQ3L31-F□	ø10	1/8"								23		18.5
LQ3L32-F□	ø8											
LQ3L33-F□	ø10	1/4"	5	9	22.5	19.5	21	47.5	44.5	24	25	21.5
LQ3L34-F□	ø8											
LQ3L35-F□	ø10	3/8"								25.5		25
LQ3L36-F□	ø8											
LQ3L41-F□	ø12	1/4"	6	10	24	22	24	52.5	50.5	23.5	29	21.5
LQ3L42-F□		3/8"								26		25
LQ3L43-F□		1/2"								30		29.5
LQ3L51-F□	ø19	3/8"	7	14	26.5	24	32	64	61.5	30.5	37	25
LQ3L52-F□		1/2"								35.5		29.5
LQ3L53-F□		3/4"								37		36
LQ3L61-F□	ø25	1/2"	8	18	30	26	41	78	74	41	49	29.5
LQ3L62-F□		3/4"								42.5		36
LQ3L63-F□		1"								46		44.5

Inch Size

Model	Applicable tubing O.D.	Connection threads Rc/NPT	B	C	E	E'	H	L ₁	L ₁ '	L ₂	M	Y
LQ3L1A-F□	1/8"	1/8"	3.5	4.8	10	9	11	28.5	27.5	19.5	14	18.5
LQ3L2A-F□	1/4"	1/8"	4	6	17	16	16	34.5	33.5	20	20	18.5
LQ3L2B-F□		1/4"								22		21.5
LQ3L3A-F□	3/8"	1/8"	5	9	22.5	19.5	21	47.5	44.5	23	25	18.5
LQ3L3B-F□		1/4"								24		21.5
LQ3L3C-F□		3/8"								25.5		25
LQ3L4A-F□	1/2"	1/4"	6	10	24.5	22.5	24	52.5	50.5	23.5	29	21.5
LQ3L4B-F□		3/8"								26		25
LQ3L4C-F□		1/2"								30		29.5
LQ3L5A-F□	3/4"	3/8"	7	14	26.5	24	32	64	61.5	30.5	37	25
LQ3L5B-F□		1/2"								35.5		29.5
LQ3L5C-F□		3/4"								37		36
LQ3L6A-F□	1"	1/2"	8	18	30	26	41	78	74	41	49	29.5
LQ3L6B-F□		3/4"								42.5		36
LQ3L6C-F□		1"								46		44.5

Dimensions

Male branch tee: LQ3B-M

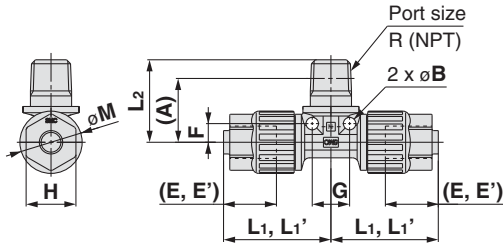

(A): Reference dimension after installation
 (E,E'): Reference dimension for the inserted tubing from the end surface of the nut
 E',L1': Nut material PVDF dimensions

Metric Size

Model	Applicable tubing O.D.	Connection threads R/NPT	A	B	E	E'	F	G	H	L ₁	L ₁ '	L ₂	M
LQ3B11-M□	ø4	1/8"	15	3.5	10	9	4.8	9.5	11	28.5	27.5	19	14
LQ3B12-M□	ø3		19.5										
LQ3B21-M□	ø6	1/8"	19.5	4	17	16	6	12	16	34.5	33.5	23.5	20
LQ3B22-M□		1/4"	20.5									26.5	
LQ3B31-M□	ø10	1/8"	22.5									26.5	
LQ3B32-M□	ø8												
LQ3B33-M□	ø10												
LQ3B34-M□	ø8	1/4"	23.5	5	22.5	19.5	9	18	21	47.5	44.5	29.5	25
LQ3B35-M□	ø10	3/8"	24									30.5	
LQ3B36-M□	ø8												
LQ3B41-M□	ø12	1/4"	27	6	24	22	10	20	24	52.5	50.5	33	29
LQ3B42-M□		3/8"	27.5									34	
LQ3B43-M□		1/2"	29									37	
LQ3B51-M□	ø19	3/8"	32.5	7	26.5	24	14	28	32	64	61.5	39	37
LQ3B52-M□		1/2"	34									42	
LQ3B53-M□		3/4"	34.5									44	
LQ3B61-M□	ø25	1/2"	42	8	30	26	18	36	41	78	74	50	49
LQ3B62-M□		3/4"	42.5									52	
LQ3B63-M□		1"										53	

Inch Size

Model	Applicable tubing O.D.	Connection threads R/NPT	A	B	E	E'	F	G	H	L ₁	L ₁ '	L ₂	M
LQ3B1A-M□	1/8"	1/8"	15	3.5	10	9	4.8	9.5	11	28.5	27.5	19	14
LQ3B2A-M□	1/4"	1/8"	19.5	4	17	16	6	12	16	34.5	33.5	23.5	20
LQ3B2B-M□		1/4"	20.5									26.5	
LQ3B3A-M□	3/8"	1/8"	22.5	5	22.5	19.5	9	18	21	47.5	44.5	26.5	25
LQ3B3B-M□		1/4"	23.5									29.5	
LQ3B3C-M□		3/8"	24									30.5	
LQ3B4A-M□	1/2"	1/4"	27	6	24.5	22.5	10	20	24	52.5	50.5	33	29
LQ3B4B-M□		3/8"	27.5									34	
LQ3B4C-M□		1/2"	29									37	
LQ3B5A-M□	3/4"	3/8"	32.5	7	26.5	24	14	28	32	64	61.5	39	37
LQ3B5B-M□		1/2"	34									42	
LQ3B5C-M□		3/4"	34.5									44	
LQ3B6A-M□	1"	1/2"	42	8	30	26	18	36	41	78	74	50	49
LQ3B6B-M□		3/4"	42.5									52	
LQ3B6C-M□		1"										53	

LQ1

LQ3

LVN

LQHB

TL/TIL

TD/TID

TH/THH

Applicable Fluid

Precautions

Series LQ3

Dimensions

Female branch tee: LQ3B-F

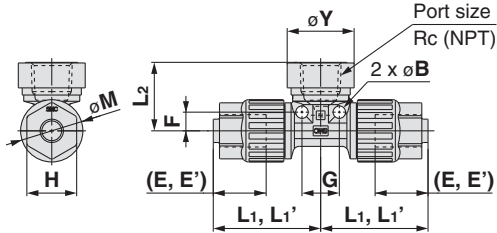

(E,E'): Reference dimension for the inserted tubing from the end surface of the nut
 (E'),L1': Nut material PVDF dimensions

Metric Size

Model	Applicable tubing O.D.	Connection threads Rc/NPT	B	E	E'	F	G	H	L ₁	L ₁ '	L ₂	M	Y
LQ3B11-F□	ø4	1/8"	3.5	10	9	4.8	9.5	11	28.5	27.5	19.5	14	18.5
LQ3B12-F□	ø3												
LQ3B21-F□	ø6	1/8"	4	17	16	6	12	16	34.5	33.5	20	20	18.5
LQ3B22-F□		1/4"									22		21.5
LQ3B31-F□	ø10	1/8"											18.5
LQ3B32-F□	ø8												
LQ3B33-F□	ø10	1/4"	5	22.5	19.5	9	18	21	47.5	44.5	24	25	21.5
LQ3B34-F□	ø8												
LQ3B35-F□	ø10	3/8"									25.5		25
LQ3B36-F□	ø8												
LQ3B41-F□	ø12	1/4"	6	24	22	10	20	24	52.5	50.5	23.5	29	21.5
LQ3B42-F□		3/8"									26		25
LQ3B43-F□		1/2"									30		29.5
LQ3B51-F□	ø19	3/8"	7	26.5	24	14	28	32	64	61.5	30.5	37	25
LQ3B52-F□		1/2"									35.5		29.5
LQ3B53-F□		3/4"									37		36
LQ3B61-F□	ø25	1/2"	8	30	26	18	36	41	78	74	41	49	29.5
LQ3B62-F□		3/4"									42.5		36
LQ3B63-F□		1"									46		44.5

Inch Size

Model	Applicable tubing O.D.	Connection threads Rc/NPT	B	E	E'	F	G	H	L ₁	L ₁ '	L ₂	M	Y
LQ3B1A-F□	1/8"	1/8"	3.5	10	9	4.8	9.5	11	28.5	27.5	19.5	14	18.5
LQ3B2A-F□	1/4"	1/8"	4	17	16	6	12	16	34.5	33.5	20	20	18.5
LQ3B2B-F□		1/4"									22		21.5
LQ3B3A-F□	3/8"	1/8"	5	22.5	19.5	9	18	21	47.5	44.5	23	25	18.5
LQ3B3B-F□		1/4"									24		21.5
LQ3B3C-F□		3/8"									25.5		25
LQ3B4A-F□	1/2"	1/4"	6	24.5	22.5	10	20	24	52.5	50.5	23.5	29	21.5
LQ3B4B-F□		3/8"									26		25
LQ3B4C-F□		1/2"									30		29.5
LQ3B5A-F□	3/4"	3/8"	7	26.5	24	14	28	32	64	61.5	30.5	37	25
LQ3B5B-F□		1/2"									35.5		29.5
LQ3B5C-F□		3/4"									37		36
LQ3B6A-F□	1"	1/2"	8	30	26	18	36	41	78	74	41	49	29.5
LQ3B6B-F□		3/4"									42.5		36
LQ3B6C-F□		1"									46		44.5

Dimensions

Male run tee: LQ3R-M

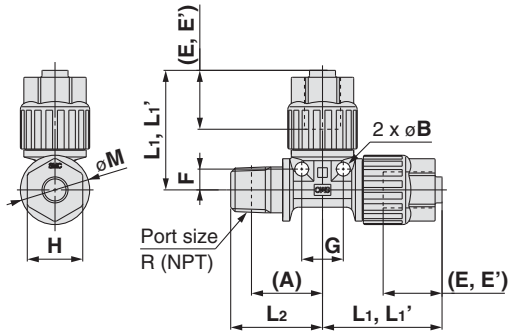

(A): Reference dimension after installation
(E,E'): Reference dimension for the inserted tubing from the end surface of the nut
(E'),L': Nut material PVDF dimensions

Metric Size

Model	Applicable tubing O.D.	Connection threads R/NPT	A	B	E	E'	F	G	H	L ₁	L ₁ '	L ₂	M
LQ3R11-M□	ø4	1/8"	15	3.5	10	9	4.8	9.5	11	28.5	27.5	19	14
LQ3R12-M□	ø3		19.5	4	17	16	6	12	16	34.5	33.5	23.5	20
LQ3R21-M□	ø6	1/8"	19.5	4	17	16	6	12	16	34.5	33.5	23.5	
LQ3R22-M□		1/4"	20.5									26.5	
LQ3R31-M□	ø10	1/8"	22.5	5	22.5	19.5	9	18	21	47.5	44.5	26.5	25
LQ3R32-M□	ø8		22.5									29.5	
LQ3R33-M□	ø10	1/4"	23.5	5	22.5	19.5	9	18	21	47.5	44.5	29.5	25
LQ3R34-M□	ø8		23.5									30.5	
LQ3R35-M□	ø10	3/8"	24	6	24	22	10	20	24	52.5	50.5	34	29
LQ3R36-M□	ø8		24									30.5	
LQ3R41-M□	ø12	1/4"	27	6	24	22	10	20	24	52.5	50.5	33	29
LQ3R42-M□		3/8"	27.5									34	
LQ3R43-M□		1/2"	29									37	
LQ3R51-M□	ø19	3/8"	32.5	7	26.5	24	14	28	32	64	61.5	39	37
LQ3R52-M□		1/2"	34									42	
LQ3R53-M□		3/4"	34.5									44	
LQ3R61-M□	ø25	1/2"	42	8	30	26	18	36	41	78	74	50	49
LQ3R62-M□		3/4"	42.5									52	
LQ3R63-M□		1"	42.5									53	

Inch Size

Model	Applicable tubing O.D.	Connection threads R/NPT	A	B	E	E'	F	G	H	L ₁	L ₁ '	L ₂	M
LQ3R1A-M□	1/8"	1/8"	15	3.5	10	9	4.8	9.5	11	28.5	27.5	19	14
LQ3R2A-M□	1/4"	1/8"	19.5	4	17	16	6	12	16	34.5	33.5	23.5	20
LQ3R2B-M□		1/4"	20.5									26.5	
LQ3R3A-M□	3/8"	1/8"	22.5	5	22.5	19.5	9	18	21	47.5	44.5	26.5	25
LQ3R3B-M□		1/4"	23.5									29.5	
LQ3R3C-M□		3/8"	24									30.5	
LQ3R4A-M□	1/2"	1/4"	27	6	24.5	22.5	10	20	24	52.5	50.5	33	29
LQ3R4B-M□		3/8"	27.5									34	
LQ3R4C-M□		1/2"	29									37	
LQ3R5A-M□	3/4"	3/8"	32.5	7	26.5	24	14	28	32	64	61.5	39	37
LQ3R5B-M□		1/2"	34									42	
LQ3R5C-M□		3/4"	34.5									44	
LQ3R6A-M□	1"	1/2"	42	8	30	26	18	36	41	78	74	50	49
LQ3R6B-M□		3/4"	42.5									52	
LQ3R6C-M□		1"	42.5									53	

LQ1

LQ3

LVN

LQHB

TL/TIL

TD/TID

TH/THH

Applicable Fluid

Precautions

Series LQ3

Dimensions

Female run tee: LQ3R-F

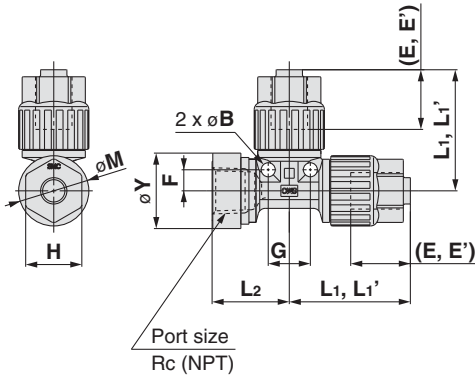

(E, E'): Reference dimension for the inserted tubing from the end surface of the nut
 (E'), L1': Nut material PVDF dimensions

Metric Size

Model	Applicable tubing O.D.	Connection threads Rc/NPT	B	E	E'	F	G	H	L ₁	L ₁ '	L ₂	M	Y
LQ3R11-F□	ø4	1/8"	3.5	10	9	4.8	9.5	11	28.5	27.5	19.5	14	18.5
LQ3R12-F□	ø3												
LQ3R21-F□	ø6	1/8"	4	17	16	6	12	16	34.5	33.5	20	20	18.5
LQ3R22-F□		1/4"											21.5
LQ3R31-F□	ø10	1/8"											18.5
LQ3R32-F□	ø8												
LQ3R33-F□	ø10	1/4"	5	22.5	19.5	9	18	21	47.5	44.5	24	25	21.5
LQ3R34-F□	ø8												
LQ3R35-F□	ø10	3/8"									25.5		25
LQ3R36-F□	ø8												
LQ3R41-F□	ø12	1/4"	6	24	22	10	20	24	52.5	50.5	26	29	21.5
LQ3R42-F□		3/8"											25
LQ3R43-F□		1/2"											29.5
LQ3R51-F□	ø19	3/8"	7	26.5	24	14	28	32	64	61.5	30.5	37	25
LQ3R52-F□		1/2"											29.5
LQ3R53-F□		3/4"											36
LQ3R61-F□	ø25	1/2"	8	30	26	18	36	41	78	74	41	49	29.5
LQ3R62-F□		3/4"											36
LQ3R63-F□		1"											44.5

Inch Size

Model	Applicable tubing O.D.	Connection threads Rc/NPT	B	E	E'	F	G	H	L ₁	L ₁ '	L ₂	M	Y
LQ3R1A-F□	1/8"	1/8"	4	17	16	6	12	16	34.5	33.5	20	20	18.5
LQ3R2A-F□	1/4"	1/8"											21.5
LQ3R2B-F□		1/4"											18.5
LQ3R3A-F□	3/8"	1/8"	5	22.5	19.5	9	18	21	47.5	44.5	24	25	21.5
LQ3R3B-F□		1/4"											25
LQ3R3C-F□		3/8"											25
LQ3R4A-F□	1/2"	1/4"	6	24.5	22.5	10	20	24	52.5	50.5	26	29	21.5
LQ3R4B-F□		3/8"											25
LQ3R4C-F□		1/2"											29.5
LQ3R5A-F□	3/4"	3/8"	7	26.5	24	14	28	32	64	61.5	30.5	37	25
LQ3R5B-F□		1/2"											29.5
LQ3R5C-F□		3/4"											36
LQ3R6A-F□	1"	1/2"	8	30	26	18	36	41	78	74	41	49	29.5
LQ3R6B-F□		3/4"											36
LQ3R6C-F□		1"											44.5

Dimensions

Union elbow: LQ3E

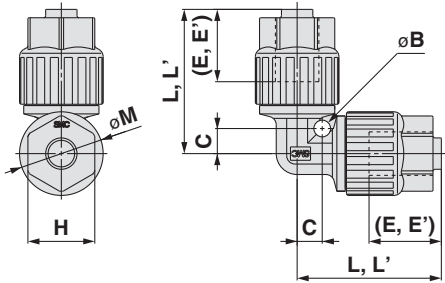

(E,E'): Reference dimension for the inserted tubing from the end surface of the nut
(E'),L': Nut material PVDF dimensions

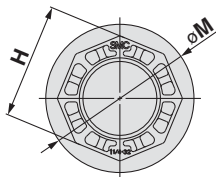

Class 7

Union tee: LQ3T

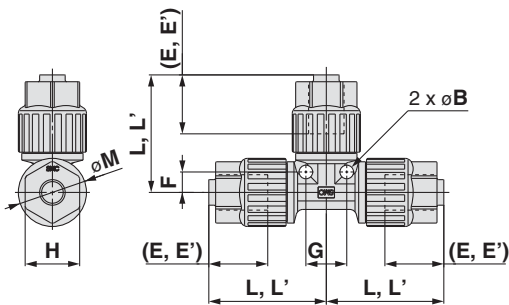

(E,E'): Reference dimension for the inserted tubing from the end surface of the nut
(E'),L': Nut material PVDF dimensions

Metric Size

Model	Applicable tubing O.D.	B	C	E	E'	H	L	L'	M
LQ3E11	ø4	3.5	4.8	10	9	11	28.5	27.5	14
LQ3E12	ø3								
LQ3E21	ø6	4	6	17	16	16	34.5	33.5	20
LQ3E31	ø10	5	9	22.5	19.5	21	47.5	44.5	25
LQ3E32	ø8								
LQ3E41	ø12	6	10	24	22	24	52.5	50.5	29
LQ3E51	ø19	7	14	26.5	24	32	64	61.5	37
LQ3E61	ø25	8	18	30	26	41	78	74	49

Inch Size

Model	Applicable tubing O.D.	B	C	E	E'	H	L	L'	M
LQ3E1A	1/8"	3.5	4.8	10	9	11	28.5	27.5	14
LQ3E2A	1/4"	4	6	17	16	16	34.5	33.5	20
LQ3E3A	3/8"	5	9	22.5	19.5	21	47.5	44.5	25
LQ3E4A	1/2"	6	10	24.5	22.5	24	52.5	50.5	29
LQ3E5A	3/4"	7	14	26.5	24	32	64	61.5	37
LQ3E6A	1"	8	18	30	26	41	78	74	49
LQ3E7A	1 1/4"	9	22	35	35	50	92.5	92.5	64

Metric Size

Model	Applicable tubing O.D.	B	E	E'	F	G	H	L	L'	M
LQ3T11	ø4	3.5	10	9	4.8	9.5	11	28.5	27.5	14
LQ3T12	ø3									
LQ3T21	ø6	4	17	16	6	12	16	34.5	33.5	20
LQ3T31	ø10	5	22.5	19.5	9	18	21	47.5	44.5	25
LQ3T32	ø8									
LQ3T41	ø12	6	24	22	10	20	24	52.5	50.5	29
LQ3T51	ø19	7	26.5	24	14	28	32	64	61.5	37
LQ3T61	ø25	8	30	26	18	36	41	78	74	49

Inch Size

Model	Applicable tubing O.D.	B	E	E'	F	G	H	L	L'	M
LQ3T1A	1/8"	3.5	10	9	4.8	9.5	11	28.5	27.5	14
LQ3T2A	1/4"	4	17	16	6	12	16	34.5	33.5	20
LQ3T3A	3/8"	5	22.5	19.5	9	18	21	47.5	44.5	25
LQ3T4A	1/2"	6	24.5	22.5	10	20	24	52.5	50.5	29
LQ3T5A	3/4"	7	26.5	24	14	28	32	64	61.5	37
LQ3T6A	1"	8	30	26	18	36	41	78	74	49

LQ1

LQ3

LVN

LQHB

TL/TIL

TD/TID

TH/THH

Applicable Fluid

Precautions

Series LQ3

Dimensions

Panel mount union: LQ3P

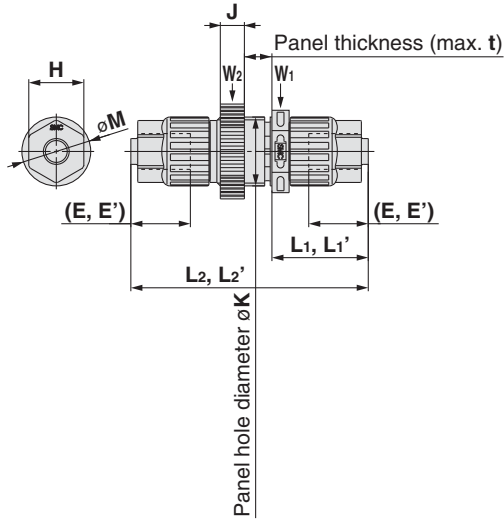

(E,E'): Reference dimension for the inserted tubing from the end surface of the nut
 (E'),L1',L2': Nut material PVDF dimensions
 W: Width across flats dimension

Metric Size

Model	Applicable tubing O.D.	E	E'	H	J	K	L ₁	L ₁ '	L ₂	L ₂ '	M	t	W ₁	W ₂
LQ3P11	ø4	10	9	11	6	14.5	23.5	22.5	58	56	14	8	16	17
LQ3P12	ø3													
LQ3P21	ø6	17	16	16	7	20.5	28	27	69	67	20	8	21	24
LQ3P31	ø10	22.5	19.5	21	7	24.5	39	36	89	83	25	8	26	28
LQ3P32	ø8													
LQ3P41	ø12	24	22	24	9	30.5	44.5	42.5	100	96	29	8	32	36
LQ3P51	ø19	26.5	24	32	9	36.5	50.5	48	117	112	37	13	41	43
LQ3P61	ø25	30	26	41	10	48.5	60	56	136	127.5	49	13	50	55

Inch Size

Model	Applicable tubing O.D.	E	E'	H	J	K	L ₁	L ₁ '	L ₂	L ₂ '	M	t	W ₁	W ₂
LQ3P1A	1/8"	10	9	11	6	14.5	23.5	22.5	58	56	14	8	16	17
LQ3P2A	1/4"	17	16	16	7	20.5	28	27	69	67	20	8	21	24
LQ3P3A	3/8"	22.5	19.5	21	7	24.5	39	36	89	83	25	8	26	28
LQ3P4A	1/2"	24.5	22.5	24	9	30.5	44.5	42.5	100	96	29	8	32	36
LQ3P5A	3/4"	26.5	24	32	9	36.5	50.5	48	117	112	37	13	41	43
LQ3P6A	1"	30	26	41	10	48.5	60	56	136	127.5	49	13	50	55

Union: LQ3U

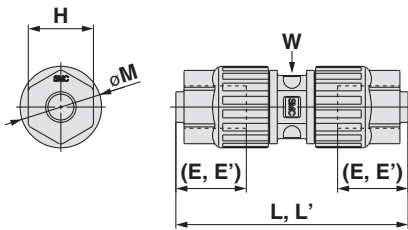

(E,E'): Reference dimension for the inserted tubing from the end surface of the nut
 (E'),L': Nut material PVDF dimensions
 W: Width across flats dimension

Metric Size

Model	Applicable tubing O.D.	E	E'	H	L	L'	M	W
LQ3U11	ø4	10	9	11	46.5	44.5	14	10
LQ3U12	ø3							
LQ3U21	ø6	17	16	16	57	55	20	14
LQ3U31	ø10	22.5	19.5	21	79	73	25	18
LQ3U32	ø8							
LQ3U41	ø12	24	22	24	88	84	29	22
LQ3U51	ø19	26.5	24	32	103	98	37	30
LQ3U61	ø25	30	26	41	122	113.5	49	36

Inch Size

Model	Applicable tubing O.D.	E	E'	H	L	L'	M	W
LQ3U1A	1/8"	10	9	11	46.5	44.5	14	10
LQ3U2A	1/4"	17	16	16	57	55	20	14
LQ3U3A	3/8"	22.5	19.5	21	79	73	25	18
LQ3U4A	1/2"	24.5	22.5	24	88	84	29	22
LQ3U5A	3/4"	26.5	24	32	103	98	37	30
LQ3U6A	1"	30	26	41	122	113.5	49	36
LQ3U7A	1 1/4"	35	35	50	142	142	64	46

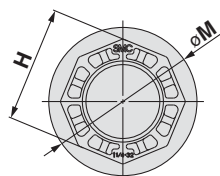

Class 7

Series LQ3 Union Reducing

How to Order

Tubing connection

LQ3 U 2 1 - R1 -

Fitting type

Symbol	Type
U	Union

Body size (according to the combination table)

Tubing type

Symbol	Type
A	Inch
1, 2	Metric

Nut material, packaging

Symbol	Nut material	Packaging
—	PFA	Clean packaging equivalent to Class M3.5
1	PFA	Standard packaging equivalent to Class M5.5
2	PVDF	Clean packaging equivalent to Class M3.5
3	PVDF	Standard packaging equivalent to Class M5.5

Type of piping (according to the combination table)

Symbol	Type
R□	Reducing

Size combination (Metric)

Size	Model	A side	B side
		Applicable tubing size (mm)	
1	LQ3U11-R1	4 x 3	3 x 2
2	LQ3U21-R1	6 x 4	4 x 3
	LQ3U21-R2		3 x 2
3	LQ3U31-R1	10 x 8	8 x 6
	LQ3U31-R2		6 x 4
	LQ3U32-R1	8 x 6	6 x 4
	LQ3U32-R2		4 x 3
4	LQ3U41-R1	12 x 10	10 x 8
	LQ3U41-R2		8 x 6
5	LQ3U51-R1	19 x 16	12 x 10
	LQ3U51-R2		10 x 8
6	LQ3U61-R1	25 x 22	19 x 16
	LQ3U61-R2		12 x 10

Size combination (Inch)

Size	Model	A side	B side
		Applicable tubing size (inch)	
2	LQ3U2A-R1	1/4" x 5/32"	1/8" x 0.086"
3	LQ3U3A-R1	3/8" x 1/4"	1/4" x 5/32"
	LQ3U3A-R2		1/8" x 0.086"
4	LQ3U4A-R1	1/2" x 3/8"	3/8" x 1/4"
	LQ3U4A-R2		1/4" x 5/32"
5	LQ3U5A-R1	3/4" x 5/8"	1/2" x 3/8"
	LQ3U5A-R2		3/8" x 1/4"
	LQ3U5A-R3		1/4" x 5/32"
6	LQ3U6A-R1	1" x 7/8"	3/4" x 5/8"
	LQ3U6A-R2		1/2" x 3/8"
7	LQ3U7A-R1	1 1/4" x 1.1"	1" x 7/8"

Note) For details of the applicable tubing sizes, refer to page 72.

Note) For details of the applicable tubing sizes, refer to page 72.

Dimensions

Union reducing: LQ3U-R

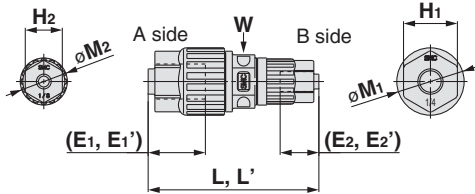

(E1, E1', E2, E2'): Reference dimension for the inserted tubing from the end surface of the nut

(E1', E2'), L': Nut material PVDF dimensions

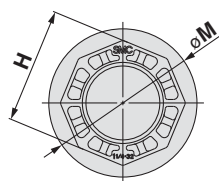

Class 7

Metric Size

Model	A side	B side	E1	E1'	E2	E2'	H1	H2	L	L'	M1	M2	W
	Applicable tubing O.D.												
LQ3U11-R1	ø4	ø3	10	9	10	9	11	11	46.5	44.5	14	14	10
LQ3U21-R1	ø6	ø4	17	16	10	9	16	11	51	48.5	20	14	14
LQ3U21-R2		ø3											
LQ3U31-R1	ø10	ø8	22.5	19.5	22.5	19.5	21	21	79	73	25	25	18
LQ3U31-R2		ø6											
LQ3U32-R1	ø8	ø6	22.5	19.5	17	16	21	16	66.5	62	25	20	18
LQ3U32-R2		ø4											
LQ3U41-R1	ø12	ø10	24	22	22.5	19.5	24	21	82.5	77	29	25	22
LQ3U41-R2		ø8											
LQ3U51-R1	ø19	ø12	26.5	24	24	22	32	24	95.5	91	37	29	30
LQ3U51-R2		ø10											
LQ3U61-R1	ø25	ø19	30	26	26.5	24	41	32	112.5	105.5	49	37	36
LQ3U61-R2		ø12											

Inch Size

Model	A side	B side	E1	E1'	E2	E2'	H1	H2	L	L'	M1	M2	W
	Applicable tubing O.D.												
LQ3U2A-R1	1/4"	1/8"	17	16	10	9	16	11	51	48.5	20	14	14
LQ3U3A-R1	3/8"	1/4"	22.5	19.5	17	16	21	16	66.5	62	25	20	18
LQ3U3A-R2		1/8"											
LQ3U4A-R1	1/2"	3/8"	24.5	22.5	22.5	19.5	24	21	82.5	77	29	25	22
LQ3U4A-R2		1/4"											
LQ3U5A-R1	3/4"	1/2"	26.5	24	22.5	19.5	32	24	95.5	91	37	29	30
LQ3U5A-R2		3/8"											
LQ3U5A-R3		1/4"											
LQ3U6A-R1	1"	3/4"	30	26	26.5	24	41	32	112.5	105.5	49	37	36
LQ3U6A-R2		1/2"											
LQ3U7A-R1	1 1/4"	1"	35	35	30	26	50	41	132.5	128.2	64	49	46

Series LQ3 Union Elbow Reducing

How to Order

Tubing connection

LQ3 E 2 1 - R1 -

Fitting type

Symbol	Type
E	Union elbow

Nut material, packaging

Symbol	Nut material	Packaging
—	PFA	Clean packaging equivalent to Class M3.5
1	PFA	Standard packaging equivalent to Class M5.5
2	PVDF	Clean packaging equivalent to Class M3.5
3	PVDF	Standard packaging equivalent to Class M5.5

Body size (according to the combination table)

Tubing type

Symbol	Type
A	Inch
1, 2	Metric

Type of piping (according to the combination table)

Symbol	Type
R□	Reducing

Size combination (Metric)

Size	Model	A side	B side
		Applicable tubing size (mm)	
1	LQ3E11-R1	4 x 3	3 x 2
2	LQ3E21-R1	6 x 4	4 x 3
	LQ3E21-R2		3 x 2
3	LQ3E31-R1	10 x 8	8 x 6
	LQ3E31-R2		6 x 4
	LQ3E32-R1	8 x 6	6 x 4
	LQ3E32-R2		4 x 3
4	LQ3E41-R1	12 x 10	10 x 8
	LQ3E41-R2		8 x 6
5	LQ3E51-R1	19 x 16	12 x 10
	LQ3E51-R2		10 x 8
6	LQ3E61-R1	25 x 22	19 x 16
	LQ3E61-R2		12 x 10

Size combination (Inch)

Size	Model	A side	B side
		Applicable tubing size (inch)	
2	LQ3E2A-R1	1/4" x 5/32"	1/8" x 0.086"
3	LQ3E3A-R1	3/8" x 1/4"	1/4" x 5/32"
	LQ3E3A-R2		1/8" x 0.086"
4	LQ3E4A-R1	1/2" x 3/8"	3/8" x 1/4"
	LQ3E4A-R2		1/4" x 5/32"
5	LQ3E5A-R1	3/4" x 5/8"	1/2" x 3/8"
	LQ3E5A-R2		3/8" x 1/4"
	LQ3E5A-R3		1/4" x 5/32"
6	LQ3E6A-R1	1" x 7/8"	3/4" x 5/8"
	LQ3E6A-R2		1/2" x 3/8"

Note) For details of the applicable tubing sizes, refer to page 72.

Note) For details of the applicable tubing sizes, refer to page 72.

Dimensions

Union elbow reducing: LQ3E-R

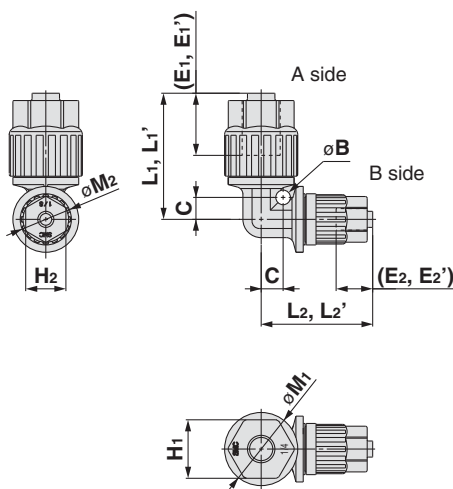

(E1, E1', E2, E2'): Reference dimension for the inserted tubing from the end surface of the nut
 (E1', E2'), L1', L2': Nut material PVDF dimensions

Metric Size

Model	A side	B side	B	C	E1	E1'	E2	E2'	H1	H2	L1	L1'	L2	L2'	M1	M2
	Applicable tubing O.D.															
LQ3E11-R1	ø4	ø3	3.5	4.8	10	9	10	9	11	11	28.5	27.5	28.5	27.5	14	14
LQ3E21-R1	ø6	ø4	4	6	17	16	10	9	16	11	34.5	33.5	30.5	29.5	20	14
LQ3E21-R2		ø3														
LQ3E31-R1	ø10	ø8	5	9	22.5	19.5	22.5	19.5	21	21	47.5	44.5	47.5	44.5	25	25
LQ3E31-R2		ø6														
LQ3E32-R1	ø8	ø6	5	9	22.5	19.5	17	16	21	16	47.5	44.5	33.5	32.5	25	14
LQ3E32-R2		ø4														
LQ3E41-R1	ø12	ø10	6	10	24	22	22.5	19.5	24	21	52.5	50.5	48.5	45.5	29	25
LQ3E41-R2		ø8														
LQ3E51-R1	ø19	ø12	7	14	26.5	24	24	22	32	24	64	61.5	58.5	56.5	37	29
LQ3E51-R2		ø10														
LQ3E61-R1	ø25	ø19	8	18	30	26	26.5	24	41	32	78	74	70	67.5	49	37
LQ3E61-R2		ø12														

Inch Size

Model	A side	B side	B	C	E1	E1'	E2	E2'	H1	H2	L1	L1'	L2	L2'	M1	M2						
	Applicable tubing O.D.																					
LQ3E2A-R1	1/4"	1/8"	4	6	17	16	10	9	16	11	34.5	33.5	30.5	29.5	20	14						
LQ3E3A-R1	3/8"	1/4"	5	9	22.5	19.5	17	16	21	16	47.5	44.5	38	37	25	20						
LQ3E3A-R2		1/8"															10	9	11	33.5	32.5	
LQ3E4A-R1	1/2"	3/8"	6	10	24.5	22.5	22.5	19.5	24	21	52.5	50.5	48.5	45.5	29	25						
LQ3E4A-R2		1/4"															17	16	16	39	38	20
LQ3E5A-R1	3/4"	1/2"	7	14	26.5	24	24.5	22.5	32	24	64	61.5	58.5	56.5	37	25						
LQ3E5A-R2		3/8"															22.5	19.5	21	61.5	53.5	50.5
LQ3E5A-R3		1/4"															17	16	16	43.5	42.5	20
LQ3E6A-R1	1"	3/4"	8	18	30	26	26.5	24	41	32	78	74	70	67.5	49	37						
LQ3E6A-R2		1/2"															24.5	22.5	24	74	64.5	62.5

Series LQ3 Union Tee Reducing

How to Order

Tubing connection

LQ3 T 2 A - R1 -

Fitting type

Symbol	Type
T	Union tee

Body size
(according to the combination table)

Tubing type

Symbol	Type
A	Inch
1, 2	Metric

Nut material, packaging

Symbol	Nut material	Packaging
—	PFA	Clean packaging equivalent to Class M3.5
1	PFA	Standard packaging equivalent to Class M5.5
2	PVDF	Clean packaging equivalent to Class M3.5
3	PVDF	Standard packaging equivalent to Class M5.5

Type of piping (according to the combination table)

Symbol	Type
R□	Reducing

Size combination (Metric)

Size	Model	A side	B side	C side
1	LQ3T11-R1	4 x 3	3 x 2	4 x 3
	LQ3T11-R5		4 x 3	3 x 2
2	LQ3T21-R1	6 x 4	4 x 3	6 x 4
	LQ3T21-R2		3 x 2	6 x 4
	LQ3T21-R5		6 x 4	4 x 3
	LQ3T21-R6		6 x 4	3 x 2
3	LQ3T31-R1	10 x 8	8 x 6	10 x 8
	LQ3T31-R2		6 x 4	10 x 8
	LQ3T31-R5	10 x 8	8 x 6	
	LQ3T31-R6	10 x 8	6 x 4	
	LQ3T32-R1	8 x 6	6 x 4	8 x 6
LQ3T32-R5	8 x 6		6 x 4	
4	LQ3T41-R1	12 x 10	10 x 8	12 x 10
	LQ3T41-R5		12 x 10	10 x 8
5	LQ3T51-R1	19 x 16	12 x 10	19 x 16
	LQ3T51-R5		19 x 16	12 x 10
6	LQ3T61-R1	25 x 22	19 x 16	25 x 22
	LQ3T61-R5		25 x 22	19 x 16

Note) For details of the applicable tubing sizes, refer to page 72.

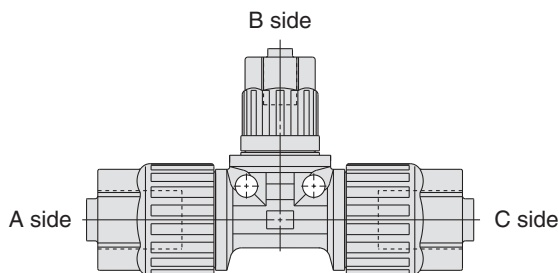

Size combination (Inch)

Size	Model	A side	B side	C side	
2	LQ3T2A-R1	1/4" x 5/32"	1/8" x 0.086"	1/4" x 5/32"	
	LQ3T2A-R5		1/4" x 5/32"	1/8" x 0.086"	
3	LQ3T3A-R1	3/8" x 1/4"	1/4" x 5/32"	3/8" x 1/4"	
	LQ3T3A-R2		1/8" x 0.086"	3/8" x 1/4"	
	LQ3T3A-R5		3/8" x 1/4"	1/4" x 5/32"	
	LQ3T3A-R7		1/4" x 5/32"	1/4" x 5/32"	
4	LQ3T3A-R9	1/4" x 5/32"	3/8" x 1/4"	1/4" x 5/32"	
	LQ3T4A-R1		3/8" x 1/4"	1/2" x 3/8"	
	LQ3T4A-R2	1/4" x 5/32"	1/2" x 3/8"		
	LQ3T4A-R5	1/2" x 3/8"	3/8" x 1/4"		
	LQ3T4A-R6	1/2" x 3/8"	1/4" x 5/32"		
	LQ3T4A-R7	3/8" x 1/4"	3/8" x 1/4"		
	LQ3T4A-R8	1/4" x 5/32"	1/4" x 5/32"		
	LQ3T4A-R9	3/8" x 1/4"	1/2" x 3/8"	3/8" x 1/4"	
	LQ3T5A-R1		1/2" x 3/8"	3/4" x 5/8"	
5	LQ3T5A-R2	3/4" x 5/8"	3/8" x 1/4"	3/4" x 5/8"	
	LQ3T5A-R3		1/4" x 5/32"	3/4" x 5/8"	
	LQ3T5A-R5	3/4" x 5/8"	1/2" x 3/8"		
	LQ3T5A-R6	3/4" x 5/8"	3/8" x 1/4"		
	LQ3T5A-R7	1/2" x 3/8"	1/2" x 3/8"		
	LQ3T5A-R9	1/2" x 3/8"	3/4" x 5/8"		
	LQ3T5A-R10	3/8" x 1/4"	3/4" x 5/8"		
	LQ3T5A-R11	3/4" x 5/8"	1/2" x 3/8"	1/4" x 5/32"	
	LQ3T5A-R12		3/4" x 5/8"	1/4" x 5/32"	
	6	LQ3T6A-R1	1" x 7/8"	3/4" x 5/8"	1" x 7/8"
		LQ3T6A-R2		1/2" x 3/8"	1" x 7/8"
		LQ3T6A-R3		3/8" x 1/4"	1" x 7/8"
LQ3T6A-R4		1/4" x 5/32"		1" x 7/8"	
LQ3T6A-R5		1" x 7/8"	3/4" x 5/8"		
LQ3T6A-R6		1" x 7/8"	1/2" x 3/8"		
LQ3T6A-R7		3/4" x 5/8"	3/4" x 5/8"		
LQ3T6A-R9		3/4" x 5/8"	1" x 7/8"	3/4" x 5/8"	
LQ3T6A-R10		1/2" x 3/8"	1" x 7/8"	1/2" x 3/8"	
LQ3T6A-R12		1" x 7/8"	1" x 7/8"	3/8" x 1/4"	
LQ3T6A-R13			1" x 7/8"	1/4" x 5/32"	
LQ3T6A-R14		3/4" x 5/8"	1" x 7/8"	1/4" x 5/32"	

Note) For details of the applicable tubing sizes, refer to page 72.

Series LQ3

Dimensions

Union tee reducing: LQ3T-R

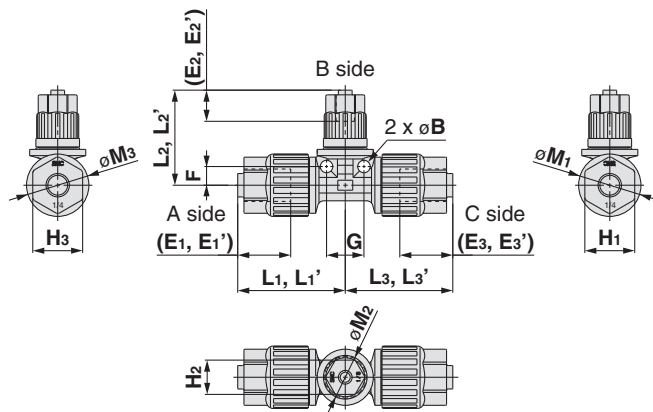

(E1, E1', E2, E2', E3, E3'): Reference dimension for the inserted tubing from the end surface of the nut
 (E1', E2', E3'), L1', L2', L3': Nut material PVDF dimensions

Metric Size

Model	A side	B side	C side	B	E1	E1'	E2	E2'	E3	E3'	F	G	H1	H2	H3	L1	L1'	L2	L2'	L3	L3'	M1	M2	M3
	Applicable tubing O.D.																							
LQ3T11-R1	ø4	ø3	ø4	3.5	10	9	10	9	10	9	4.8	9.5	11	11	11	28.5	27.5	28.5	27.5	28.5	27.5	14	14	14
LQ3T11-R5		ø4	ø3																					
LQ3T21-R1	ø6	ø4	ø6	4	17	16	10	9	17	16	6	12	16	11	16	34.5	33.5	30.5	29.5	34.5	33.5	20	14	20
LQ3T21-R2		ø3	ø6																					
LQ3T21-R5		ø6	ø4																					
LQ3T21-R6		ø6	ø3																					
LQ3T31-R1	ø10	ø8	ø10	5	22.5	19.5	22.5	19.5	22.5	19.5	9	18	21	21	21	47.5	44.5	47.5	44.5	38	37	25	25	25
LQ3T31-R2		ø6	ø10																					
LQ3T31-R5		ø10	ø8																					
LQ3T31-R6		ø10	ø6																					
LQ3T32-R1	ø8	ø6	ø8	5	22.5	19.5	17	16	22.5	19.5	9	18	21	21	21	47.5	44.5	38	37	47.5	44.5	25	20	25
LQ3T32-R5		ø8	ø6																					
LQ3T41-R1	ø12	ø10	ø12	6	24	22	22.5	19.5	24	22	10	20	24	21	24	52.5	50.5	48.5	45.5	52.5	50.5	29	25	29
LQ3T41-R5		ø12	ø10																					
LQ3T51-R1	ø19	ø12	ø19	7	26.5	24	24	22	26.5	24	14	28	32	24	32	64	61.5	58.5	56.5	64	61.5	37	29	37
LQ3T51-R5		ø19	ø12																					
LQ3T61-R1	ø25	ø19	ø25	8	30	26	26.5	24	30	26	18	36	41	32	41	78	74	70	67.5	78	74	49	37	49
LQ3T61-R5		ø25	ø19																					

Inch Size

Model	A side	B side	C side	B	E1	E1'	E2	E2'	E3	E3'	F	G	H1	H2	H3	L1	L1'	L2	L2'	L3	L3'	M1	M2	M3	
	Applicable tubing O.D.																								
LQ3T2A-R1	1/4"	1/8"	1/4"	4	17	16	10	9	17	16	6	12	16	11	16	34.5	33.5	30.5	29.5	34.5	33.5	20	14	20	
LQ3T2A-R5		1/4"	1/8"																						
LQ3T3A-R1	3/8"	1/4"	3/8"	5	22.5	19.5	10	9	17	16	9	18	21	16	21	47.5	44.5	38	37	47.5	44.5	25	14	25	
LQ3T3A-R2		1/8"	3/8"																						
LQ3T3A-R5		3/8"	1/4"																						
LQ3T3A-R7		1/4"	1/4"																						
LQ3T3A-R9	1/4"	3/8"	1/4"	17	16	22.5	19.5	17	16	22.5	19.5	9	18	21	16	21	38	37	47.5	44.5	20	25	25		
LQ3T4A-R1	3/8"	1/2"																							
LQ3T4A-R2	1/4"	1/2"	6	24.5	22.5	24.5	22.5	22.5	19.5	17	10	20	24	24	21	52.5	50.5	52.5	50.5	48.5	45.5	29	29	25	
LQ3T4A-R5	1/2"	3/8"																							
LQ3T4A-R6	1/2"	1/4"																							
LQ3T4A-R7	3/8"	3/8"																							
LQ3T4A-R8	1/4"	1/4"	22.5	19.5	24.5	22.5	17	16	22.5	19.5	9	18	21	16	21	48.5	45.5	39	38	48.5	45.5	25	20	20	
LQ3T4A-R9	3/8"	3/8"																							
LQ3T5A-R1	3/4"	1/2"	3/4"	7	26.5	24	24.5	22.5	26.5	24	14	28	32	24	32	64	61.5	58.5	56.5	64	61.5	37	29	37	
LQ3T5A-R2		3/8"	3/4"																						
LQ3T5A-R3		1/4"	3/4"																						
LQ3T5A-R5		3/4"	1/2"																						
LQ3T5A-R6	3/4"	3/8"	24.5	22.5	26.5	24	24.5	22.5	19.5	17	16	22.5	19.5	9	18	21	16	21	38	37	47.5	44.5	20	25	
LQ3T5A-R7	1/2"	1/2"																							
LQ3T5A-R9	1/2"	3/4"	1/2"	24.5	22.5	26.5	24	24.5	22.5	19.5	9	18	21	16	21	48.5	45.5	58.5	56.5	64	61.5	29	29	29	
LQ3T5A-R10	3/8"	3/4"	3/8"																						
LQ3T5A-R11	3/4"	1/2"	1/4"	26.5	24	24.5	22.5	17	16	22.5	19.5	9	18	21	16	21	58.5	56.5	64	61.5	44.5	43.5	37	29	37
LQ3T5A-R12		3/4"	1/4"																						
LQ3T6A-R1	1"	3/4"	1"	8	30	26	26.5	24	30	26	18	36	41	24	41	78	74	70	67.5	78	74	49	25	49	
LQ3T6A-R2		1/2"	1"																						
LQ3T6A-R3		3/8"	1"																						
LQ3T6A-R4		1/4"	1"																						
LQ3T6A-R5	1"	3/4"	30	26	30	26	26.5	24	22.5	19.5	9	18	21	16	21	78	74	78	74	70	67.5	49	37		
LQ3T6A-R6	1"	1/2"																							
LQ3T6A-R7	3/4"	3/4"	26.5	24	26.5	24	26.5	24	22.5	19.5	9	18	21	16	21	70	67.5	70	67.5	70	67.5	37	37		
LQ3T6A-R9	3/4"	1"																						3/4"	
LQ3T6A-R10	1/2"	1"	1/2"	24.5	22.5	30	26	24.5	22.5	19.5	9	18	21	16	21	64.5	62.5	64.5	62.5	64.5	62.5	29	29		
LQ3T6A-R12	1"	3/8"																							
LQ3T6A-R13	1"	1"	1/4"	30	26	30	26	22.5	19.5	17	16	22.5	19.5	9	18	21	78	74	78	74	60	57	49	49	
LQ3T6A-R14	3/4"	1"	1/4"																						

Series LQ3 Space Saving Union Elbow

How to Order

Tubing connection

LQ3 E 21 - S -

Fitting type

Symbol	Type
E	Union elbow

Nut material, packaging

Symbol	Nut material	Packaging
—	PFA	Clean packaging equivalent to Class M3.5
1	PFA	Standard packaging equivalent to Class M5.5
2	PVDF	Clean packaging equivalent to Class M3.5
3	PVDF	Standard packaging equivalent to Class M5.5

Thread type

Symbol	Type
S	Space saving

Size combination

Size	No.	Applicable tubing size (mm)
2	1	6 x 4
3	1	10 x 8
3	2	8 x 6
4	1	12 x 10
5	1	19 x 16
6	1	25 x 22

Note) For details of the applicable tubing sizes, refer to page 72.

Size	Symbol	Applicable tubing size (inch)
2	A	1/4" x 5/32"
3	A	3/8" x 1/4"
4	A	1/2" x 3/8"
5	A	3/4" x 5/8"
6	A	1" x 7/8"
7	A	1 1/4" x 1.1"

Note) For details of the applicable tubing sizes, refer to page 72.

Dimensions

Space saving union elbow: LQ3E-S

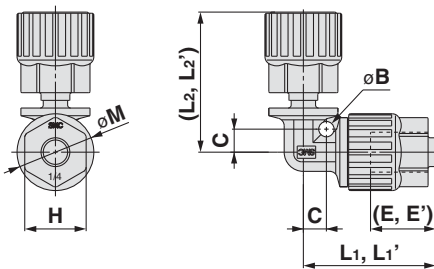

(E, E'): Reference dimension for the inserted tubing from the end surface of the nut
 (E'), L1', L2': Nut material PVDF dimensions

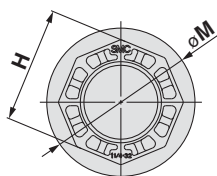

Class 7

Metric Size

Model	Applicable tubing O.D.	B	C	E	E'	H	L ₁	L ₁ '	L ₂	L ₂ '	M
LQ3E21-S	ø6	4	6	17	16	16	34.5	33.5	39.5	38.5	20
LQ3E31-S	ø10	5	9	22.5	19.5	21	47.5	44.5	52.5	49.5	25
LQ3E32-S	ø8								49.5	46.5	
LQ3E41-S	ø12	6	10	24	22	24	52.5	50.5	54.5	52.5	29
LQ3E51-S	ø19	7	14	26.5	24	32	64	61.5	66	63.5	37
LQ3E61-S	ø25	8	18	30	26	41	78	74	80	76	49

Inch Size

Model	Applicable tubing O.D.	B	C	E	E'	H	L ₁	L ₁ '	L ₂	L ₂ '	M
LQ3E2A-S	1/4"	4	6	17	16	16	34.5	33.5	39.5	38.5	20
LQ3E3A-S	3/8"	5	9	22.5	19.5	21	47.5	44.5	49.5	46.5	25
LQ3E4A-S	1/2"	6	10	24.5	22.5	24	52.5	50.5	54.5	52.5	29
LQ3E5A-S	3/4"	7	14	26.5	24	32	64	61.5	66	63.5	37
LQ3E6A-S	1"	8	18	30	26	41	78	74	80	76	49
LQ3E7A-S	1 1/4"	9	22	35	35	50	92.5	92.5	97.5	97.5	64

Series LQ3

Space Saving Branch Tee

How to Order

Tubing connection

LQ3 T 21 - S B -

• Fitting type

Symbol	Type
T	Union tee

• Nut material, packaging

Symbol	Nut material	Packaging
—	PFA	Clean packaging equivalent to Class M3.5
1	PFA	Standard packaging equivalent to Class M5.5
2	PVDF	Clean packaging equivalent to Class M3.5
3	PVDF	Standard packaging equivalent to Class M5.5

• Thread type

Symbol	Type
B	Branch tee

• Tubing type

Symbol	Type
S	Space saving

• Size combination

Size	No.	Applicable tubing size (mm)
2	1	6 x 4
3	1	10 x 8
3	2	8 x 6
4	1	12 x 10
5	1	19 x 16
6	1	25 x 22

Note) For details of the applicable tubing sizes, refer to page 72.

Size	Symbol	Applicable tubing size (inch)
2	A	1/4" x 5/32"
3	A	3/8" x 1/4"
4	A	1/2" x 3/8"
5	A	3/4" x 5/8"
6	A	1" x 7/8"

Note) For details of the applicable tubing sizes, refer to page 72.

Dimensions

Space saving branch tee: LQ3T-SB

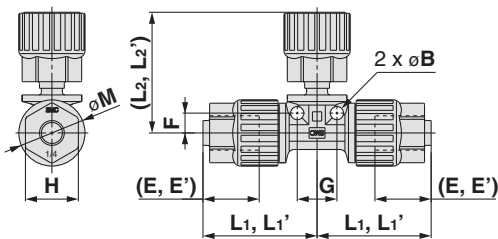

(E,E'): Reference dimension for the inserted tubing from the end surface of the nut

(E'),L1',L2': Nut material PVDF dimensions

Metric Size

Model	Applicable tubing O.D.	B	E	E'	F	G	H	L ₁	L ₁ '	L ₂	L ₂ '	M
LQ3T21-SB	ø6	4	17	16	6	12	16	34.5	33.5	39.5	38.5	20
LQ3T31-SB	ø10	5	22.5	19.5	9	18	21	47.5	44.5	52.5	49.5	25
LQ3T32-SB	ø8									49.5	46.5	
LQ3T41-SB	ø12	6	24	22	10	20	24	52.5	50.5	54.5	52.5	29
LQ3T51-SB	ø19	7	26.5	24	14	28	32	64	61.5	66	63.5	37
LQ3T61-SB	ø25	8	30	26	18	36	41	78	74	80	76	49

Inch Size

Model	Applicable tubing O.D.	B	E	E'	F	G	H	L ₁	L ₁ '	L ₂	L ₂ '	M
LQ3T2A-SB	1/4"	4	17	16	6	12	16	34.5	33.5	39.5	38.5	20
LQ3T3A-SB	3/8"	5	22.5	19.5	9	18	21	47.5	44.5	49.5	46.5	25
LQ3T4A-SB	1/2"	6	24.5	22.5	10	20	24	52.5	50.5	54.5	52.5	29
LQ3T5A-SB	3/4"	7	26.5	24	14	28	32	64	61.5	66	63.5	37
LQ3T6A-SB	1"	8	30	26	18	36	41	78	74	80	76	49

Series LQ3 Space Saving Run Tee

How to Order

Tubing connection

LQ3 T 21 - S R -

Fitting type

Symbol	Type
T	Union tee

Nut material, packaging

Symbol	Nut material	Packaging
—	PFA	Clean packaging equivalent to Class M3.5
1	PFA	Standard packaging equivalent to Class M5.5
2	PVDF	Clean packaging equivalent to Class M3.5
3	PVDF	Standard packaging equivalent to Class M5.5

Thread type

Symbol	Type
R	Run tee

Tubing type

Symbol	Type
S	Space saving

Size combination

Size	No.	Applicable tubing size (mm)
2	1	6 x 4
3	1	10 x 8
3	2	8 x 6
4	1	12 x 10
5	1	19 x 16
6	1	25 x 22

Size	Symbol	Applicable tubing size (inch)
2	A	1/4" x 5/32"
3	A	3/8" x 1/4"
4	A	1/2" x 3/8"
5	A	3/4" x 5/8"
6	A	1" x 7/8"

Note) For details of the applicable tubing sizes, refer to page 72.

Note) For details of the applicable tubing sizes, refer to page 72.

Dimensions

Space saving run tee: LQ3T-SR

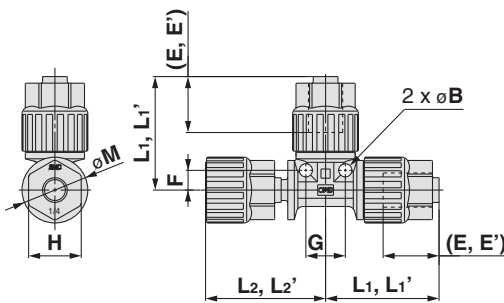

Metric Size

Model	Applicable tubing O.D.	B	E	E'	F	G	H	L ₁	L ₁ '	L ₂	L ₂ '	M
LQ3T21-SR	ø6	4	17	16	6	12	16	34.5	33.5	39.5	38.5	20
LQ3T31-SR	ø10	5	22.5	19.5	9	18	21	47.5	44.5	52.5	49.5	25
LQ3T32-SR	ø8									49.5	46.5	
LQ3T41-SR	ø12	6	24	22	10	20	24	52.5	50.5	54.5	52.5	29
LQ3T51-SR	ø19	7	26.5	24	14	28	32	64	61.5	66	63.5	37
LQ3T61-SR	ø25	8	30	26	18	36	41	78	74	80	76	49

Inch Size

Model	Applicable tubing O.D.	B	E	E'	F	G	H	L ₁	L ₁ '	L ₂	L ₂ '	M
LQ3T2A-SR	1/4"	4	17	16	6	12	16	34.5	33.5	39.5	38.5	20
LQ3T3A-SR	3/8"	5	22.5	19.5	9	18	21	47.5	44.5	49.5	46.5	25
LQ3T4A-SR	1/2"	6	24.5	22.5	10	20	24	52.5	50.5	54.5	52.5	29
LQ3T5A-SR	3/4"	7	26.5	24	14	28	32	64	61.5	66	63.5	37
LQ3T6A-SR	1"	8	30	26	18	36	41	78	74	80	76	49

(E, E'): Reference dimension for the inserted tubing from the end surface of the nut

(E'), L₁', L₂': Nut material PVDF dimensions

Series LQ3 Tubing Extension Straight Connector

How to Order

Tubing connection

LQ3 H 2A - T -

Fitting type

Symbol	Type
H	Connector

Nut material, packaging

Symbol	Nut material	Packaging
—	PFA	Clean packaging equivalent to Class M3.5
1	PFA	Standard packaging equivalent to Class M5.5
2	PVDF	Clean packaging equivalent to Class M3.5
3	PVDF	Standard packaging equivalent to Class M5.5

Thread type

Symbol	Type
T	Tubing extension

Size combination

Size	No.	Applicable tubing size (mm)
2	1	6 x 4
3	1	10 x 8
3	2	8 x 6
4	1	12 x 10
5	1	19 x 16
6	1	25 x 22

Note) For details of the applicable tubing sizes, refer to page 72.

Size	Symbol	Applicable tubing size (inch)
2	A	1/4" x 5/32"
3	A	3/8" x 1/4"
4	A	1/2" x 3/8"
5	A	3/4" x 5/8"
6	A	1" x 7/8"
7	A	1 1/4" x 1.1"

Note) For details of the applicable tubing sizes, refer to page 72.

Dimensions

Tubing extension straight connector: LQ3H-T

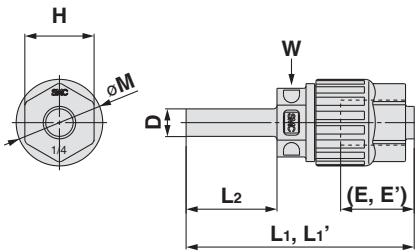

(E,E'): Reference dimension for the inserted tubing from the end surface of the nut
 (E'),L': Nut material PVDF dimensions
 W: Width across flats dimension

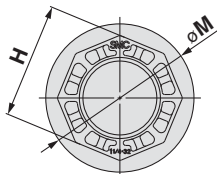

Class 7

Metric Size

Model	Applicable tubing O.D.	D	E	E'	H	L ₁	L ₁ '	L ₂	M	W
LQ3H21-T	ø6	ø6	17	16	16	53	51.5	18	20	14
LQ3H31-T	ø10	ø10	22.5	19.5	21	67.5	64.5	22.5	25	18
LQ3H32-T	ø8	ø8								
LQ3H41-T	ø12	ø12	24	22	24	74	72	24	29	22
LQ3H51-T	ø19	ø19	26.5	24	32	83.5	81	26.5	37	30
LQ3H61-T	ø25	ø25	30	26	41	97.5	93.5	31	49	36

Inch Size

Model	Applicable tubing O.D.	D	E	E'	H	L ₁	L ₁ '	L ₂	M	W
LQ3H2A-T	1/4"	1/4"	17	16	16	53	51.5	18	20	14
LQ3H3A-T	3/8"	3/8"	22.5	19.5	21	65.5	62.5	23.5	25	18
LQ3H4A-T	1/2"	1/2"	24.5	22.5	24	72	70	25	29	22
LQ3H5A-T	3/4"	3/4"	26.5	24	32	83.5	81	26.5	37	30
LQ3H6A-T	1"	1"	30	26	41	97.5	93.5	31	49	36
LQ3H7A-T	1 1/4"	1 1/4"	35	35	50	120.5	120.5	41.5	64	46

Series LQ3 Straight Adapter

How to Order

Tubing connection

LQ3 A 21 -

Fitting type

Symbol	Type
A	Straight adapter

Nut material, packaging

Symbol	Nut material	Packaging
—	PFA	Clean packaging equivalent to Class M3.5
1	PFA	Standard packaging equivalent to Class M5.5
2	PVDF	Clean packaging equivalent to Class M3.5
3	PVDF	Standard packaging equivalent to Class M5.5

Size combination

Size	No.	Applicable tubing size (mm)	Applicable piping size
2	1	6 x 4	ø13.7 x ø9
2	2		ø21.3 x ø15.4
2	3		ø26.7 x ø20.5
2	4		ø33.4 x ø26.3
2	5		ø60.3 x ø52.5
3	1	10 x 8	ø13.7 x ø9
3	2	8 x 6	
3	3	10 x 8	ø21.3 x ø15.4
3	4	8 x 6	
3	5	10 x 8	ø26.7 x ø20.5
3	6	8 x 6	
3	7	10 x 8	
3	8	8 x 6	ø33.4 x ø26.3
4	1	12 x 10	
4	2		ø26.7 x ø20.5
4	3		ø33.4 x ø26.3
4	4		ø60.3 x ø52.5
5	1	19 x 16	ø21.3 x ø15.4
5	2		ø26.7 x ø20.5
5	3		ø33.4 x ø26.3
6	1	25 x 22	ø26.7 x ø20.5
6	2		ø33.4 x ø26.3
6	3		ø60.3 x ø52.5

Note) For details of the applicable tubing sizes, refer to page 72.

Size	Symbol	Applicable tubing size (inch)	Applicable piping size
2	A	1/4" x 5/32"	ø13.7 x ø9
2	B		ø21.3 x ø15.4
2	C		ø26.7 x ø20.5
2	D		ø33.4 x ø26.3
2	E		ø60.3 x ø52.5
3	A	3/8" x 1/4"	ø13.7 x ø9
3	B		ø21.3 x ø15.4
3	C		ø26.7 x ø20.5
4	A	1/2" x 3/8"	ø21.3 x ø15.4
4	B		ø26.7 x ø20.5
4	C		ø33.4 x ø26.3
4	D		ø60.3 x ø52.5
5	A	3/4" x 5/8"	ø21.3 x ø15.4
5	B		ø26.7 x ø20.5
5	C		ø33.4 x ø26.3
6	A	1" x 3/4"	ø26.7 x ø20.5
6	B		ø33.4 x ø26.3
6	C		ø60.3 x ø52.5
7	A	1 1/4" x 1.1"	ø33.4 x ø26.3

Note) For details of the applicable tubing sizes, refer to page 72.

LQ1

LQ3

LVN

LQHB

TL/TIL

TD/TID

TH/THH

Applicable Fluid

Precautions

Series LQ3

Dimensions

Straight Adapter: LQ3A

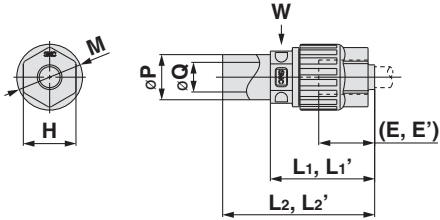

(E,E'): Reference dimension for the inserted tubing from the end surface of the nut
 (E'),L1',L2': Nut material PVDF dimensions
 W: Width across flats dimension

Metric Size

Model	E	E'	H	L1	L1'	L2	L2'	M	P	Q	W
LQ3A21	17	16	16	32	30.5	46	44.5	20	13.7	9	14
LQ3A22						58	56.5		21.3	15.4	
LQ3A23				70.5	69	26.7	20.5				
LQ3A24				74.5	73	33.4	26.3				
LQ3A25				32.5	31	60.3	52.5				
LQ3A31	22.5	19.5	21	42	39	56	65	25	13.7	9	18
LQ3A32				40		54			21.3	15.4	
LQ3A33				42		68			26.7	20.5	
LQ3A34				40		66					
LQ3A35				42	68	33.4	26.3				
LQ3A36				40	66						
LQ3A37				44	41	82	79		60.3	52.5	
LQ3A38				42		80					
LQ3A41	24	22	24	47	45	80	78	29	21.3	15.4	22
LQ3A42				26.7					20.5		
LQ3A43				33.4					26.3		
LQ3A44				49					47	88	
LQ3A51	26.5	24	32	57	54.5	95	92.5	37	21.3	15.4	30
LQ3A52									26.7	20.5	
LQ3A53									33.4	26.3	
LQ3A61	30	26	41	66.5	62.5	104.5	100.5	49	26.7	20.5	36
LQ3A62				33.4					26.3		
LQ3A63				68.5					64.5	107.5	

Inch Size

Model	E	E'	H	L1	L1'	L2	L2'	M	P	Q	W			
LQ3A2A	17	16	16	32	30.5	46	44.5	20	13.7	9	14			
LQ3A2B						58	56.5		21.3	15.4				
LQ3A2C				70.5	69	26.7	20.5							
LQ3A2D				74.5	73	33.4	26.3							
LQ3A2E				32.5	31	60.3	52.5							
LQ3A3A	22.5	19.5	21	40	39	56	53	25	13.7	9	18			
LQ3A3B						66	65		21.3	15.4				
LQ3A3C				26.7	20.5									
LQ3A4A				21.3	15.4									
LQ3A4B	24.5	22.5	24	47	45	80	78	29	26.7	20.5	22			
LQ3A4C				33.4					26.3					
LQ3A4D				49					47	88		86	60.3	52.5
LQ3A5A				21.3					15.4					
LQ3A5B	26.5	24	32	57	54.5	95	92.5	37	26.7	20.5	30			
LQ3A5C									33.4	26.3				
LQ3A6A									26.7	20.5				
LQ3A6B	30	26	41	66.5	62.5	104.5	100.5	49	33.4	26.3	36			
LQ3A6C				60.3					52.5					
LQ3A7A				68.5					64.5	107.5		103.5	60.3	52.5
LQ3A7A	35	35	50	79	79	117	117	64	33.4	26.3	46			

Series LQ3 Union Flange

How to Order

Tubing connection

LQ3 F 22 -

Fitting type

Symbol	Type
F	Union flange

Nut material, packaging

Symbol	Nut material	Packaging
—	PFA	Clean packaging equivalent to Class M3.5
1	PFA	Standard packaging equivalent to Class M5.5
2	PVDF	Clean packaging equivalent to Class M3.5
3	PVDF	Standard packaging equivalent to Class M5.5

Size combination

Size	No.	Applicable tubing size (mm)	Applicable flange size
2	2	6 x 4	10K-20A
4	2	12 x 10	10K-20A
4	3		10K-25A
5	1	19 x 16	10K-15A
5	2		10K-20A
5	3		10K-25A
6	2	25 x 22	10K-20A
6	3		10K-25A
6	4		10K-40A

Size	Symbol	Applicable tubing size (inch)	Applicable flange size
2	B	1/4" x 5/32"	10K-20A
4	B	1/2" x 3/8"	10K-20A
4	C		10K-25A
5	A	3/4" x 5/8"	10K-15A
5	B		10K-20A
5	C		10K-25A
6	B	1" x 7/8"	10K-20A
6	C		10K-25A
6	D		10K-40A

Note) For details of the applicable tubing sizes, refer to page 72.

Note) For details of the applicable tubing sizes, refer to page 72.

Dimensions

Union Flange: LQ3F

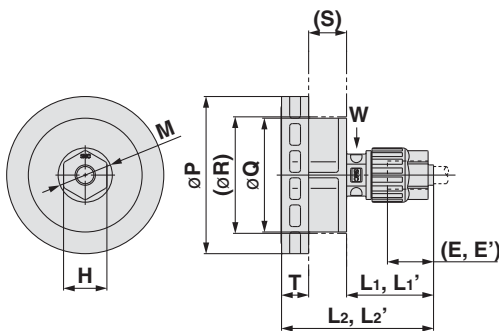

Metric Size

Model	E	E'	H	L ₁	L ₁ '	L ₂	L ₂ '	M	P	Q	R	S	T	W
LQ3F22	17	16	16	32.1	30.9	56.1	54.9	20	58	42	43	14	10	14
LQ3F42	24	22	24	49	46.8	73	70.8	29	58	42	43	14	10	22
LQ3F43									69					
LQ3F51	26.5	24	32	58	55.3	80	77.3	37	53	42	43	14	10	30
LQ3F52									58					
LQ3F53									69					
LQ3F62	30	26	41	68.5	64.2	92.5	88.2	49	58	47	48	16	10	36
LQ3F63									69					
LQ3F64									84					

Inch Size

Model	E	E'	H	L ₁	L ₁ '	L ₂	L ₂ '	M	P	Q	R	S	T	W
LQ3F2B	17	16	16	32.1	30.9	56.1	54.9	20	58	42	43	14	10	14
LQ3F4B	24.5	22.5	24	49	46.8	73	70.8	29	58	42	43	14	10	22
LQ3F4C									69					
LQ3F5A	26.5	24	32	58	55.3	80	77.3	37	53	42	43	14	10	30
LQ3F5B									58					
LQ3F5C									69					
LQ3F6B	30	26	41	68.5	64.2	92.5	88.2	49	58	47	48	16	10	36
LQ3F6C									69					
LQ3F6D									84					

- (E,E'): Reference dimension for the inserted tubing from the end surface of the nut
(E'),L₁',L₂': Nut material PVDF dimensions
W: Width across flats dimension
(R): I.D. of JIS flange necessary to mount this product. (Additional modification is needed.)
JIS flange is not included in the product.

LQ1

LQ3

LVN

LQHB

TL/TIL

TD/TID

TH/TH

Applicable Fluid

Precautions

Series LQ3

How to Order Space Saving Type Fittings

This product, for use with products with one nut attached (insert bushing) has one nut removed.

LQ3 E 6A - SN -

Fitting type

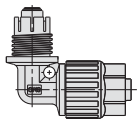
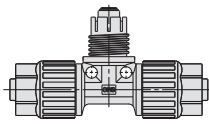
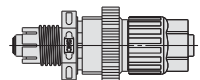
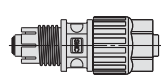
E	T
Union Elbow 	Union Tee 
P	U
Panel Mount Union 	Union 

Packaging

Symbol	Packaging
—	Clean packaging equivalent to Class M3.5
1	Standard packaging equivalent to Class M5.5

Without a nut (including insert bushing) in one part

Applicable tubing size

Symbol		Applicable tubing size (mm)
Size	No.	
2	1	6 x 4
3	1	10 x 8
3	2	8 x 6
4	1	12 x 10
5	1	19 x 16
6	1	25 x 22

Symbol		Applicable tubing size (inch)
Size	No.	
2	A	1/4" x 5/32"
3	A	3/8" x 1/4"
4	A	1/2" x 3/8"
5	A	3/4" x 5/8"
6	A	1" x 7/8"



Note 1) Please choose the same size fitting as the fitting of the connecting product.

Note 2) For details of applicable tubing sizes, refer to page 72.

Connection example

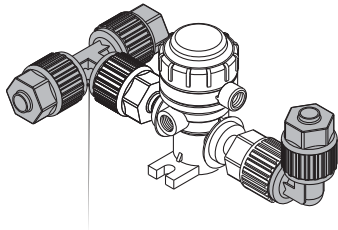

Options

Blanking plug

LQ3-1 P 03-1 -

Size

Symbol	Size
1	1
2	2
3	3
4	4
5	5
6	6
7	7

Fitting type

Symbol	Type
P	Plug

Thread type

Symbol	Type
1	Male

Packaging

Symbol	Packaging
—	Clean packaging equivalent to Class M3.5
1	Standard packaging equivalent to Class M5.5

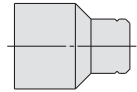

Used to block fittings which are not being used.

Applicable tubing size

Metric Size

Symbol	Applicable tubing size	Size
03	ø3 x ø2	1
04	ø4 x ø3	1
06	ø6 x ø4	2
08	ø8 x ø6	3
10	ø10 x ø8	3
12	ø12 x ø10	4
19	ø19 x ø16	5
25	ø25 x ø22	6

Inch Size

Symbol	Applicable tubing size	Size
03	1/8" x 0.086"	1
07	1/4" x 5/32"	2
11	3/8" x 1/4"	3
13	1/2" x 3/8"	4
19	3/4" x 5/8"	5
25	1" x 7/8"	6
32	1 1/4" x 1.1"	7

Note) For details of the applicable tubing sizes, refer to page 72.

Tubing plug

LQ3-1 P 03-2 -

Size

Symbol	Size
1	1
2	2
3	3
4	4
5	5
6	6

Fitting type

Symbol	Type
P	Plug

Type of piping

Symbol	Type
2	Tubing

Nut material, packaging

Symbol	Nut material	Packaging
—	PFA	Clean packaging equivalent to Class M3.5
1	PFA	Standard packaging equivalent to Class M5.5
2	PVDF	Clean packaging equivalent to Class M3.5
3	PVDF	Standard packaging equivalent to Class M5.5

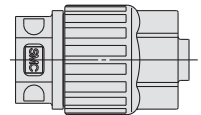

Used to block tubing which are not being used.

Applicable tubing size

Metric Size

Symbol	Applicable tubing size	Size
03	ø3 x ø2	1
04	ø4 x ø3	1
06	ø6 x ø4	2
08	ø8 x ø6	3
10	ø10 x ø8	3
12	ø12 x ø10	4
19	ø19 x ø16	5
25	ø25 x ø22	6

Inch Size

Symbol	Applicable tubing size	Size
03	1/8" x 0.086"	1
07	1/4" x 5/32"	2
11	3/8" x 1/4"	3
13	1/2" x 3/8"	4
19	3/4" x 5/8"	5
25	1" x 7/8"	6

Note) For details of the applicable tubing sizes, refer to page 72.

Nut

LQ3-1 N 03-

Size

Symbol	Size
1	1
2	2
3	3
4	4
5	5
6	6
7	7

Fitting type

Symbol	Type
N	Nut

Nut material, packaging

Symbol	Nut material	Packaging
—	PFA	Clean packaging equivalent to Class M3.5
1	PFA	Standard packaging equivalent to Class M5.5
2	PVDF	Clean packaging equivalent to Class M3.5
3	PVDF	Standard packaging equivalent to Class M5.5

Applicable tubing size

Metric Size

Symbol	Applicable tubing size	Size
03	ø3 x ø2	1
04	ø4 x ø3	1
06	ø6 x ø4	2
08	ø8 x ø6	3
10	ø10 x ø8	3
12	ø12 x ø10	4
19	ø19 x ø16	5
25	ø25 x ø22	6

Inch Size

Symbol	Applicable tubing size	Size
03	1/8" x 0.086"	1
07	1/4" x 5/32"	2
11	3/8" x 1/4"	3
13	1/2" x 3/8"	4
19	3/4" x 5/8"	5
25	1" x 7/8"	6
32	1 1/4" x 1.1"	7

Note) For details of the applicable tubing sizes, refer to page 72.

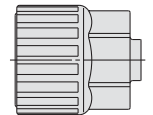

LQ1

LQ3

LVN

LQHB

TL/TIL

TD/TID

TH/TIH

Applicable Fluid

Precautions

High Purity Fluoropolymer Needle Valve Series *LVN*



How to Order

LVN **2** 0 - S **07**

Body class

Symbol	Body class	Orifice dia.
2	2	ø4.4
3	3	ø8
4	4	ø10

Port B (OUT) different dia. size

Symbol	Application
—	Port A & B same size
Refer to the applicable tubing table to the left.	Different diameter tubing can be selected within the same body class.

LQ2 fittings

A port (IN) Applicable tubing size

Symbol	Connecting tubing O.D.	Body class		
		2	3	4
Metric sizes				
04	4 x 3	●		
06	6 x 4	○	●	
08	8 x 6		●	
10	10 x 8		○	●
12	12 x 10			○
Inch sizes				
03	1/8" x 0.086"	●		
05	3/16" x 1/8"	●		
07	1/4" x 5/32"	○	●	
11	3/8" x 1/4"		○	●
13	1/2" x 3/8"			○

○ Basic size ● With reducer

Note 1) Applicable fittings: LQ2

Note 2) For details of the applicable tubing sizes, refer to page 72.

Different diameter tubing order example

Different diameter tubing (with plug-in reducer) can be selected within the same body class.

(Example) Body class 3

A side: ø10 x ø8

B side: ø8 x ø6

Order as shown below.

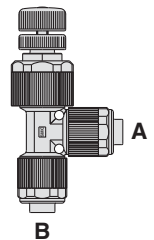

LVN30-S **10** **08**

- Different dia. tubing size (B side)
- Applicable tubing size (A side)



⚠ Specific Product Precautions

Be sure to read before handlings.
Refer to back cover for Safety Instructions.

Piping

⚠ Caution

1. Connect tubing with special tools.

Refer to the pamphlet "High-Purity Fluoropolymer Fittings Hyper fitting/Series LQ1, 2 Work Procedure Instructions" (M-E05-1) for connecting tubing and special tools. (Downloadable from our web site.)

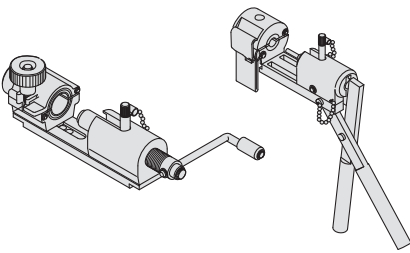

2. Tighten the nut to the end surface of the body. As a guide, refer to the proper tightening torques shown below.

Tightening torque for piping

Body class	Torque (N·m)
2	1.5 to 2.0
3	3.0 to 3.5
4	7.5 to 9.0

Standard Specifications

Model		LVN20	LVN30	LVN40
Tubing O.D. (Note)	Metric size	4, 6	6, 8, 10	10, 12
	Inch size	1/8", 3/16", 1/4"	1/4", 3/8"	3/8", 1/2"
Orifice diameter		ø4.4	ø8	ø10
Flow characteristics	Av x 10 ⁻⁶ m ²	12	33.6	52.8
	Cv	0.5	1.4	2.2
Withstand pressure (MPa)		1		
Operating pressure (MPa)		0 to 0.5		
Fluid temperature (°C)		5 to 90		
Ambient temperature (°C)		0 to 60		
Weight (kg)		0.055	0.115	0.185

Note) For details of the applicable tubing sizes, refer to page 72.

Different Diameter Tubing Applicable with Reducer

Different diameter tubing can be selected (within a body class) by using a nut and insert bushing (reducer). Applicable fitting: LQ2

Body class	Tubing O.D.									
	Metric sizes					Inch sizes				
	4	6	8	10	12	1/8"	3/16"	1/4"	3/8"	1/2"
2	●	○				●	●	○		
3		●	●	○				●	○	
4				●	○				●	○

Note) Refer to page 37 for information on changing tubing sizes. ○ Basic size ● With reducer

Flow Characteristics (Fluid: Water)

LVN20

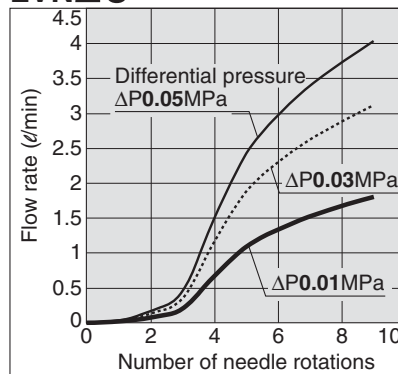

LVN30

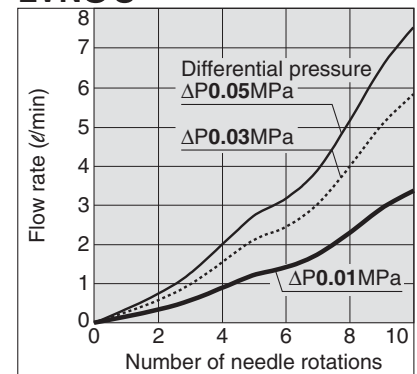

LVN40

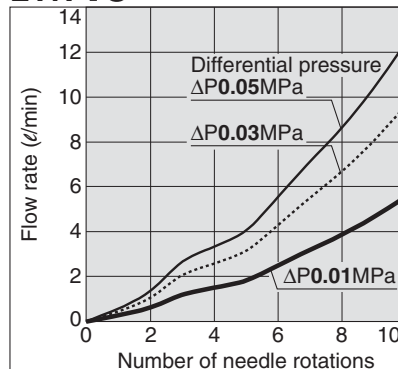

Series LVN

Construction

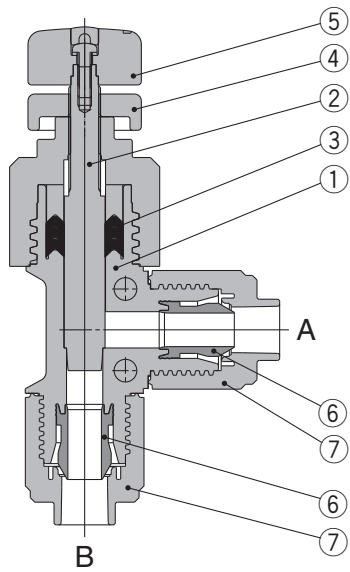

With reducer

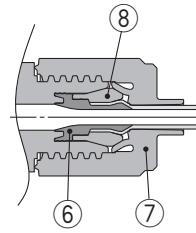

Body class 2

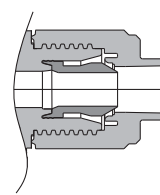

Part lists

No.	Description	Material
1	Body	PFA
2	Needle	PCTFE
3	V seal	PTFE
4	Lock nut	PVDF
5	Adjustment handle	PVDF
6	Insert bushing	PFA
7	Nut	PFA
8	Collar	PFA

Dimensions

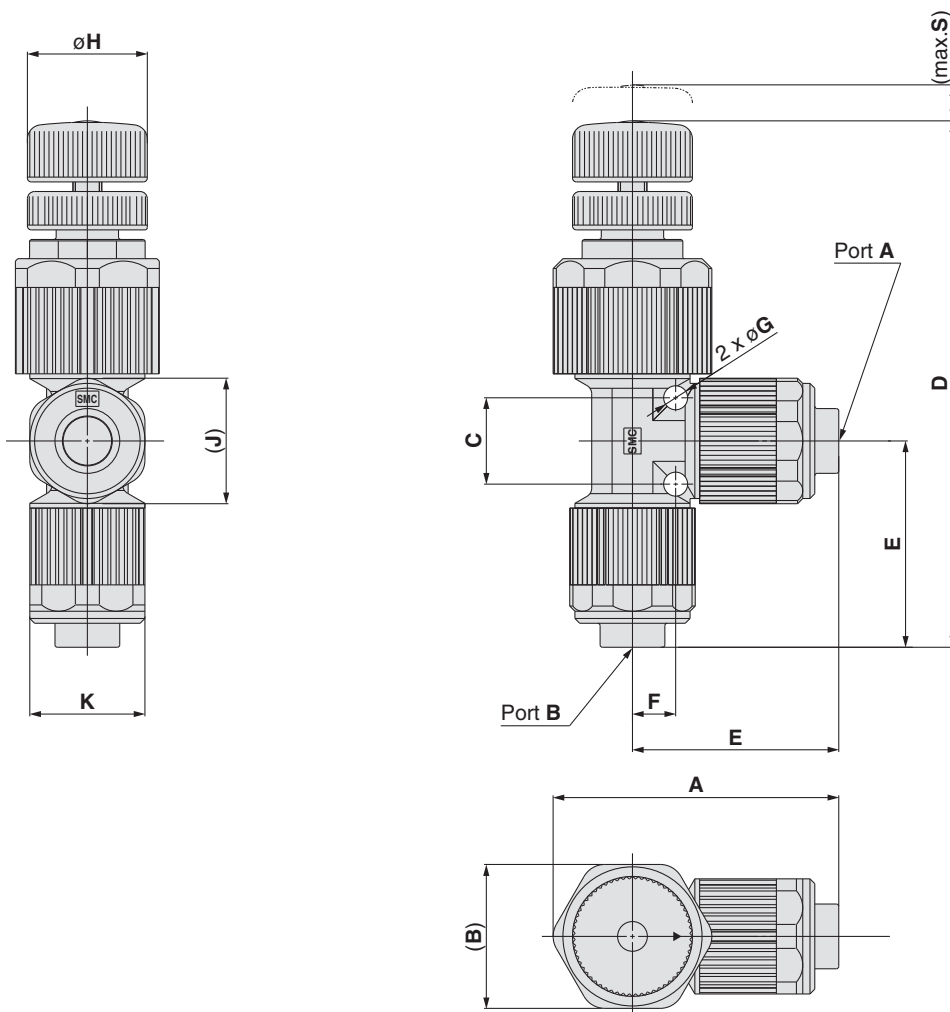

Model	A	B	C	D	E	F	G	H	J	K	S
LVN20	48	24	12	88	34.5	6	4	14	20	18	2.4
LVN30	60	30	18	110	43	9	5	25	26	24	7.5
LVN40	72	36	22	124	52	11	6	25	33	30	8

Fluoropolymer Bore Through Connector Series **LQHB**

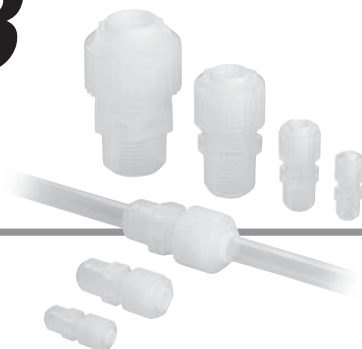

How to Order

Tubing connection

LQHB 07 - [] []

Fitting type

Symbol	Type
HB	Bore through connector

Nut material, packaging

Symbol	Nut material	Packaging
—	PFA	Clean packaging equivalent to Class M3.5
1	PFA	Standard packaging equivalent to Class M5.5

Thread type

Symbol	Type
—	R
N	NPT

Size combination

Symbol	Size	Applicable tubing size (mm)	Tubing O.D.
03	1	3 x 2	1/8"
04		4 x 3	
06	2	6 x 4	1/4"
08	3	8 x 6	3/8"
10		10 x 8	
12	4	12 x 10	1/2"
19	5	19 x 16	3/4"
25	6	25 x 22	1"

Symbol	Size	Applicable tubing size (inch)	Tubing O.D.
03	1	1/8" x 0.086"	1/8"
07	2	1/4" x 5/32"	1/4"
11	3	3/8" x 1/4"	3/8"
13	4	1/2" x 3/8"	1/2"
19	5	3/4" x 5/8"	3/4"
25	6	1" x 7/8"	1"

Note) For details of the applicable tubing sizes, refer to page 72.

Specifications

Maximum operating pressure (at 20°C)	1.0Mpa (Refer to Note 1)
Operating temperature	0 to 200°C (Refer to Note 1)
Applicable tube diameter	Please refer to the Combination Chart.

Precautions

1. The operating pressure or operating temperature range for each tubing size differs depending on the usage conditions. Keep the supplied fluid pressure and temperature within the range of each specification.
2. The piping should be arranged in such a way that no extraction force other than the fluid pressure should be added to the tubing.
3. Avoid using in instances where the nut is soaked in the fluid.
4. Screw in the R or NPT screw after inserting the tubing. (If the screw is screwed in first, the tubing may be hard to insert.)

Piping

⚠ Caution

1. As with the nut tightening, refer to the tightening torques below as a guide.

Tightening torque for piping

Body size	Torque (N·m)
1	0.7 to 0.9
2	1.6 to 1.8
3	3.2 to 3.5
4	5.0 to 5.3
5	10.0 to 10.5
6	22.5 to 23.0

Series LQHB

Dimensions

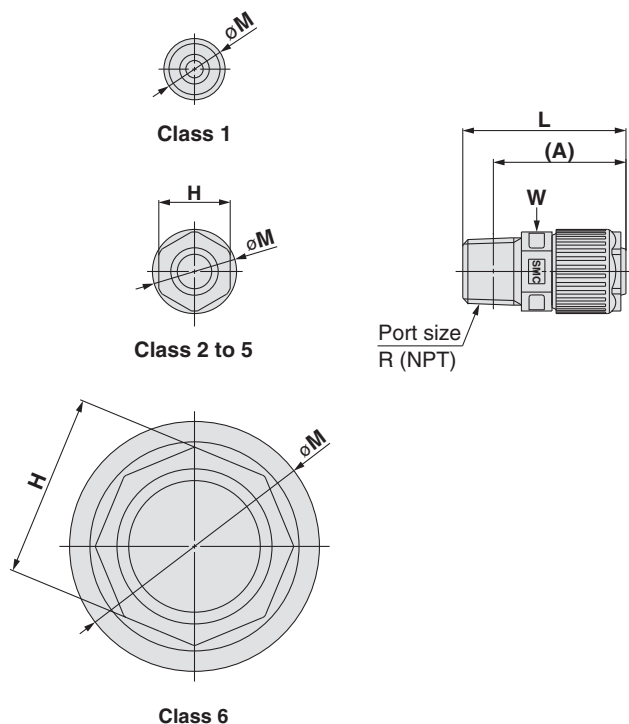

Metric Size

Model	Size	A	H	L	M	W
LQHB03-□	1	23	—	27	11.5	10
LQHB04-□						
LQHB06-□	2	28	14	34	16.5	14
LQHB08-□	3	35.6	17	42.1	23	19
LQHB10-□						
LQHB12-□	4	41	21	49	28	23
LQHB19-□	5	52.1	26	61.1	39	32
LQHB25-□	6	67	36	77	49	46

Inch Size

Model	Size	A	H	L	M	W
LQHB03-□	1	23	—	27	11.5	10
LQHB07-□	2	28	14	34	16.5	14
LQHB11-□	3	35.6	17	42.1	23	19
LQHB13-□	4	41	21	49	28	23
LQHB19-□	5	52.1	26	61.1	39	32
LQHB25-□	6	67	36	77	49	46

Types of Use

There are presumably two different types of use for the bore through connector as indicated in conditions A and B, and the specifications will differ according to the type of use.

- Condition A**
- For applications including boring through panels or walls, etc.
 - Atmospheric release.

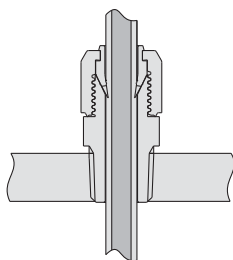

- Condition B**
- For applying sustained pressure to the female thread.
 - Using the same pressure and temperature as that of the inside of the tube.

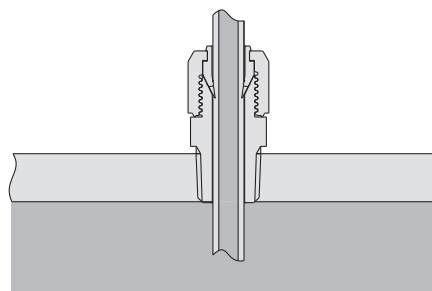

Operating range for the bore through connector

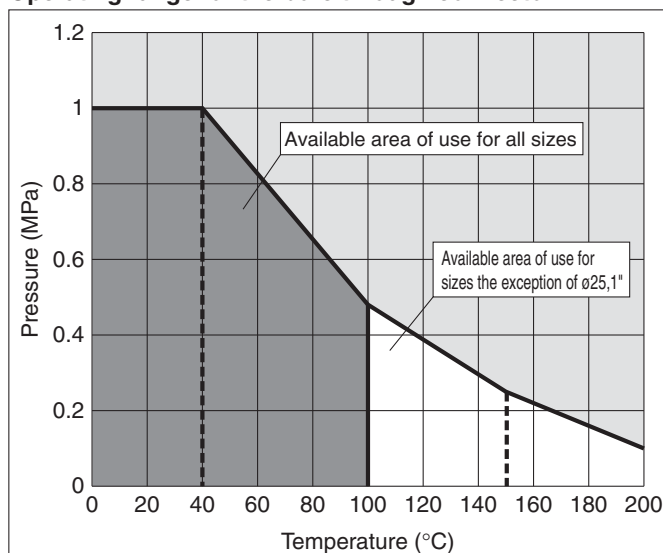

Operating range of use for the bore through connector

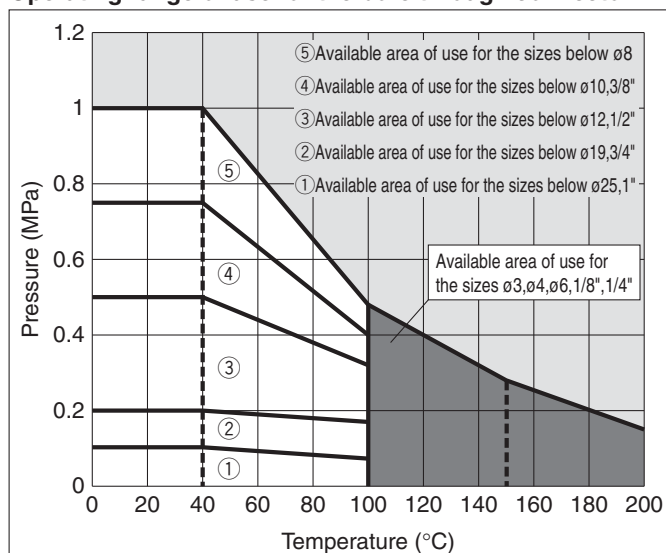



Series LQ1/LQ3/LVN/LQHB

Applicable Fluids

Material and fluid compatibility check list for high purity fluoropolymer fittings

Chemical		Compatibility
Acetic acid	100%	○
Acetone	100%	○ Note 1,2)
Ammonium fluoride	40%	○
Ammonium hydroxide	30%	○
Butyl acetate	100%	○
Methylene chloride	100%	○
Hydrochloric acid	38%	○
Hydrofluoric acid	50%	○
Hydrogen peroxide	60%	○
Methanol	100%	○
Methyl ethyl Ketone	—	○ Note 2)
Nitric acid	70%	○ Note 2)
Phosphoric acid	86%	○
Caustic potash	85%	○
Sulfuric acid	100%	○ Note 2)
Toluene	—	○ Note 1,2)
Xylene	—	○ Note 2)
Sodium hydroxide	100%	○ Note 2)
1.1.1-Trichloroethane	100%	○ Note 2)
Rhosphorus pentachloride	—	○
Isobutyl alcohol	—	○ Note 1)
Isopropyl alcohol	—	○ Note 1)
Ozone	—	○
Ethyl acetate	—	○ Note 1,2)
DI water (Pure water)	—	○
Nitrogen	—	○
Ultrapure water	—	○
Tmah	—	○ Note 2)

Table symbol ○ : can be used.



The material and fluid compatibility check list provides reference values as a guide only.

Note 1) Since static electricity may be generated, implement suitable countermeasures.

Note 2) In the case of nut with PVDF material, it cannot be used due to atmosphere or temperature. Use the nut with PFA material.

- Fluid temperature indicates compatibility below 200°C (below 150°C in the case of a nut with PVDF material).
- The material and fluid compatibility check list provides reference values as a guide only, therefore we do not guarantee the application to our product.
- The data above is based on the information presented by the material manufacturers.
- SMC is not responsible for its accuracy and any damage happened because of this data.



Series LQ1/LQ3/LVN/LQHB High Purity Fluoropolymer Fittings/ Needle Valve/ Bore Through Connector/ Precautions 1

Be sure to read before handling.
Refer to back cover for Safety Instructions.

Design and Selection

Warning

1. Confirm the specifications.

Give careful consideration to operating conditions such as the application, fluid and environment, and use within the operating ranges specified in this catalogue.

2. Fluid

Operate within the indicated fluid temperature range.

3. Maintenance space

Ensure the necessary space for maintenance and inspections.

4. Fluid pressure range

Keep the supplied fluid pressure within the operating pressure range shown in the catalogue.

5. Countermeasures for static electricity

Since static electricity may be generated depending on the fluid being used, implement suitable countermeasures.

Mounting

Warning

1. After mounting, perform suitable function and leak tests to confirm that the mounting is correct.

2. Instruction manual

Mount and operate the product after reading the manual carefully and understanding its contents. Also keep the manual where it can be referred to as necessary.

Piping

Caution

1. Connect tubing with special tools.

Refer to the pamphlet "High-Purity Fluoropolymer Fittings Hyper fitting/Series LQ1, 2 Work Procedure Instructions" (M-E05-1) for connecting tubing and special tools. (Downloadable from our web site.)

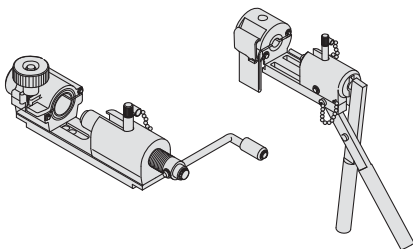

Piping

Caution

2. Tighten the nut until it touches the end surface of the body, and then tighten it an additional 1/8 turn. If the nut won't turn any further, then it means a sufficient tightening has occurred. Refer to the proper tightening torques shown below.

Nut tightening torque for piping

Body class	Torque (N·m)			
	LQ1	LQ3	LVN	LQHB
1	— ^{Note)}	0.7 to 0.9	—	0.7 to 0.9
2	0.3 to 0.4	1.6 to 1.8	1.5 to 2.0	1.6 to 1.8
3	0.8 to 1.0	3.2 to 3.5	3.0 to 3.5	3.2 to 3.5
4	1.0 to 1.2	5.0 to 5.3	7.5 to 9.0	5.0 to 5.3
5	2.5 to 3.0	10.0 to 10.5	—	10.0 to 10.5
6	5.5 to 6.0	22.5 to 23.0	—	22.5 to 23.0
7	—	23.0 to 26.5	—	—



Note) The LQ1 Body class 1 must be tightened manually.

3. Use sealant tape for the piping of taper thread parts such as LQ□H and LQ□L.

Tape the ridges tightly with the sealant tape, starting one ridge width left from thread end side. 3 to 4 sealant tapes are required.

Taper thread mounting torque

Bore size	Torque (N·m)
1/8	0.6 to 0.9
1/4	0.8 to 1.2
3/8	1.0 to 1.6
1/2	1.5 to 2.0
3/4	2.0 to 2.7
1	2.5 to 3.6
1 1/4	5.5 to 7.5

4. Nut tightening torque for the panel mount union.

Nut tightening torque for the panel mount union

Body class	Torque (N·m)
1	0.5 to 0.6
2	0.6 to 0.7
3	1.2 to 1.3
4	4.5 to 4.6
5	6.8 to 6.9
6	12.4 to 12.5



Series LQ1/LQ3/LVN/LQHB

High Purity Fluoropolymer Fittings/ Needle Valve/ Bore Through Connector/ Precautions 2

Be sure to read before handling.
Refer to back cover for Safety Instructions.

Operating Environment

Warning

1. Do not use in locations having an explosive atmosphere.
2. Do not operate in locations where vibration or impact occurs.
3. In locations near heat sources, block off radiated heat.

Maintenance

Warning

1. Perform maintenance in accordance with the procedures in the instruction manual.
Improper handling can cause damage.
2. When removing or reinstalling fittings, remove any remaining chemicals and carefully replace them with DI water (pure water) or air, etc., before beginning work activities.
3. Tightening of taper threads for piping

Because the taper threads are made of resin, minute leakage may gradually occur due to stress relaxation. Perform periodic inspections, and if leakage is detected correct the problem by additional tightening. If additional tightening becomes ineffective, replace the fitting with a new product.

4. Check the following during regular maintenance, and replace components as necessary.
 - a) Scratches, gouges, abrasion, corrosion
 - b) Twisting, flattening or distortion of tubing
 - c) Hardening, deterioration or softening of tubing
5. Do not repair or patch the replaced tubing or fittings for reuse.

Operating Precautions

Warning

1. Operate within the range of the maximum operating pressure.

Caution

1. After a long period of non-use, perform inspections before beginning operation.
2. Use sufficient care in the handling of series LQ clean packaging types when their packaging is opened.
3. For LVN Series, be careful not to apply any excessive force to the stroke end, which fully opens and closes, to avoid accidental damage or changes in flow characteristics.

Installation of Tubing

Caution

1. Cut the end of the tubing at a right angle and pass it through the fitting nut. After placing the tubing in the holder, push it onto the insert bushing until it stops and clamp it with the knob.
As a guide when tightening the tubing with the knob, maintain a uniform gap (approx. 2 mm) on both sides of the holder.
 - When the tubing is curved, straighten it out before using it.
 - The tubing may slip if there is oil or dust, etc., on the holder. Remove the contamination using alcohol or another suitable cleaner.

Use of Tubing

Caution

1. Refer to the applicable tubing sizes shown below for tubing to be used.

Applicable tubing sizes

	Connection tubing size	O.D. (mm)		Internal thickness (mm)	
		Standard size	Tolerance	Standard size	Tolerance
Metric sizes	ø3 x ø2	3.0	+0.2 -0.1	0.5	±0.06
	ø4 x ø3	4.0			
	ø6 x ø4	6.0			
	ø8 x ø6	8.0	+0.3 -0.1	1.0	±0.1
	ø10 x ø8	10.0			
	ø12 x ø10	12.0			
	ø19 x ø16	19.0			
ø25 x ø22	25.0	1.5	±0.15		
Inch sizes	1/8" x 0.086"	3.18		+0.2 -0.1	0.5
	3/16" x 1/8"	4.75	0.8		
	1/4" x 5/32"	6.35	1.2		±0.12
	3/8" x 1/4"	9.53	+0.3 -0.1	1.6	
	1/2" x 3/8"	12.7			
	3/4" x 5/8"	19.0			
	1" x 7/8"	25.4			
	1 1/4" x 1.1"				

LQ1

LQ3

LVN

LQHB

TL/TIL

TD/TID

TH/THH

Applicable Fluid

Precautions

High Purity Fluoropolymer Tubing Series TL/TIL

Material: Super PFA

Series and Specifications

		Metric sizes (Series TL)						Inch sizes (Series TIL)							
Tubing model		TL0403	TL0604	TL0806	TL1008	TL1210	TL1916	TIL01	TILB01	TIL05	TIL07	TIL11	TIL13	TIL19	TIL25
Nominal diameter		—	—	—	—	—	—	1/8"	1/8"	3/16"	1/4"	3/8"	1/2"	3/4"	1"
Tubing size		ø4 x ø3	ø6 x ø4	ø8 x ø6	ø10 x ø8	ø12 x ø10	ø19 x ø16	1/8" x 0.086"	1/8" x 1/16"	3/16" x 1/8"	1/4" x 5/32"	3/8" x 1/4"	1/2" x 3/8"	3/4" x 5/8"	1" x 7/8"
O.D. (mm)	Basic diameter	4	6	8	10	12	19	3.18	3.18	4.75	6.35	9.53	12.7	19.05	25.4
	Tolerance	±0.1				+0.2 -0.1		±0.1				+0.2 -0.1			
Thickness (mm)	Basic diameter	0.5	1				1.5	0.5	0.8	0.8	1.2	1.6			
	Tolerance	±0.05	±0.1				±0.15	±0.05	±0.08	±0.08	±0.12	±0.15			
Bundle	10m	—	—	—	●	●	●	—	—	—	—	●	●	—	—
	20m	●	●	●	●	●	●	●	—	●	●	●	●	●	●
	50m	●	●	●	●	●	●	●	—	●	●	●	●	●	●
	100m	●	●	●	●	●	●	●	—	●	●	●	●	●	—
	50Ft (16m)	—	—	—	—	—	—	●	●	●	●	●	●	●	●
	100Ft (33m)	—	—	—	—	—	—	●	●	●	●	●	●	●	●
Straight pipe	2m	●	●	●	●	●	●	—	●	●	●	●	●	●	●
Color		Translucent (color of material)													
Applicable fluid		Refer to the applicable fluid in page 76.													
Applicable fittings ^{Note 3)}		LQ1, LQ2, LQ3													
Max. operating pressure (at 20°C) ^{Note 1)}		1MPa			0.9MPa	0.7MPa	0.6MPa	1MPa					0.7MPa	0.5MPa	
Burst pressure (at 20°C)		4.9MPa	6.9MPa	4.7MPa	3.6MPa	2.9MPa	2.6MPa	6.4MPa	9.9MPa	6.7MPa	7.9MPa	6.7MPa	4.6MPa	2.8MPa	2.0MPa
Min. bending radius (mm) ^{Note 2)}		20		40	65	110	160	12	6	20		30	60	160	290
Max. operating temperature (Fixed use)		260 °C													
Material		Super PFA													



Note 1) • The maximum operating pressure is the value at 20°C. For other temperatures, calculate from the burst pressure drop coefficient.
Furthermore, an abnormal temperature increase due to adiabatic compression can cause tubing to burst. To operate at a temperature other than 20°C, the operating pressure must be no more than the value calculated using the equation below: When the value (calculated using the formula below) exceeds 1 MPa, the Max. operating pressure is 1 MPa.
(Max. operating pressure) = 1/4 x (burst pressure drop coefficient) x (burst pressure at 20°C)
• When using a fluid in liquid form, the surge pressure must be no more than the maximum operating pressure.
A surge pressure higher than the maximum operating pressure can cause breakage of the fitting or bursting of the tubing.

Note 2) The minimum bending radius is measured using the method shown in the figure at the right.
Note 3) One-touch and insert fittings can also be used.

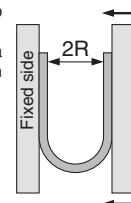

At a temperature of 20°C bend the tubing into a U shape. Then with one side fixed, gradually close the other side and measure 2R at the point where the tubing folds or flattens, etc.

Burst pressure drop curve

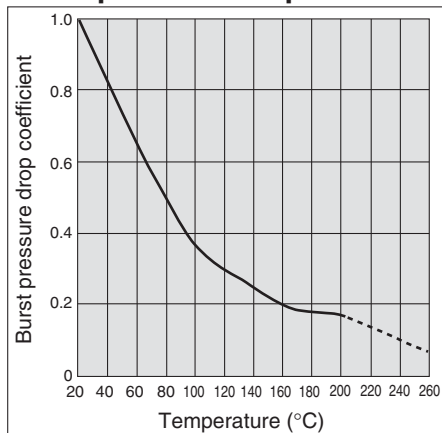

Eluting fluorine ion amount ^{Note 4)} (µg/g)

Type	Fluorine ion
Eluting amount	0.1 or less

A 15 g piece of fluororesin tubing is cut off, washed in DI water (puer water) and immersed in 15 ml of 25% methyl alcohol extract at room temperature for 24 hours. Then the extract is diluted with DI water (puer water) to be subjected to a quantitative analysis of fluorine ions.

How to Order

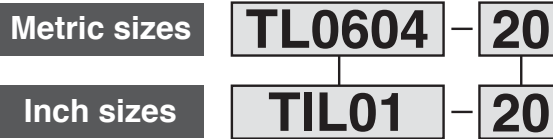

Tubing Model

Length Applicable to both metric and inch size

Symbol	Type	Length
10	Roll	10 m
20		20 m
50		50 m
100		100 m
2S	Straight	2 m

Eluting metal ion amount ^{Note 4)} (ng/cm²)

Type	Al	Fe	Ni	Na	Ca
Eluting amount	4.5	0.3	0.2	7.1	1.3

The interior of the fluororesin tubing is washed with super deionized water. Approximately 20g of super high purity hydrofluoric acid (48%) is measured and injected into the tubing. The interior wall of the tubing is immersed at normal temperature for one week with both ends of the tubing plugged. Then the extract was diluted with super deionized water to be subjected to a quantitative analysis on Al, Fe, Ni, Na and Ca by the stripping method.

Length Applicable to inch size only

Symbol	Type	Length
16	Roll	50 Ft. (16 m)
33		100 Ft. (33 m)

Please refer to the "Series and Specifications" above, as the tubing length differs depending on each size.

Note 4) Figures shown in tables are representative values, not guaranteed values.

Soft Fluoropolymer Tubing Metric Size Series TD

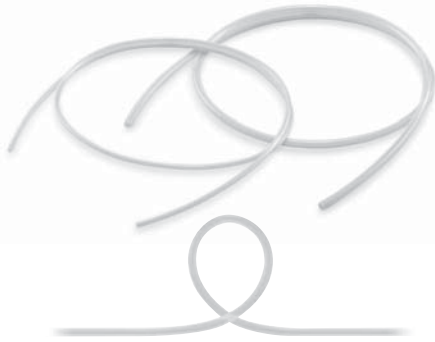

Flexibility: Improved by approx. 20%

* SMC comparison (Fluoropolymer tubing, Series TL/TIL)

Compatible with the Food Sanitation Law

- Compatible with the test conforming to the Food Sanitation Law based on the 370th notice given by the Ministry of Health and Welfare in 1959.
- Compatible with the §177-1550 dissolution test approved by FDA (Food and Drug Administration).

Operating Temperature: Max. 260°C

It varies depending on the operating pressure. Refer to the graph for the maximum operating pressure.

How to measure the minimum bending radius



Bend the tubing into the U-form at a temperature of 20°C. Fix one end and close loop gradually. Measure 2R when the deformed ratio of the tubing diameter at bending reaches 5%.

Maximum Operating Pressure

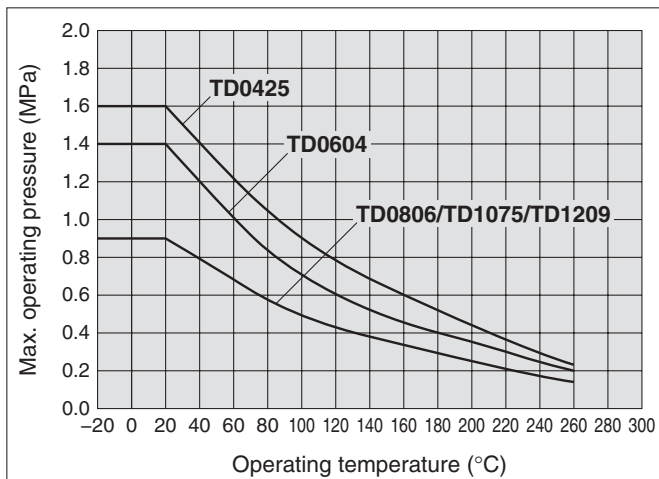

Model/Specifications

Size		Metric size				
Model		TD0425	TD0604	TD0806	TD1075	TD1209
Tubing O.D. (mm)		4	6	8	10	12
Tubing I.D. (mm)		2.5	4	6	7.5	9
Roll	10m	●	●	●	●	●
	20m	●	●	●	●	●
Color		Translucent (material color)				
Applicable fluid		Refer to the applicable fluid in page 76.				
Fluid ^{Note 1)}		Air, Water, Inert gas				
Applicable fittings ^{Note 2)}		Insert Fittings Miniature fittings M, MS series (Hose nipple type) Fluoropolymer fitting: Series LQ1, LQ2, LQ3 ^{Note 3)}				
Max. operating pressure (MPa)	20°C	1.6	1.4	0.9	0.9	0.9
	100°C	0.9	0.7	0.5	0.5	0.5
	200°C	0.45	0.35	0.25	0.25	0.25
	260°C	0.23	0.2	0.15	0.15	0.15
Min. bending radius (mm) ^{Note 4)}	Recommended radius	15	25	45	55	75
	Refraction value	8	16	31	35	41
Max. operating temperature (fixed usage)		260°C				
Material		Modified PTFE (Polytetrafluoroethylene resin)				

Note 1) When using a liquid fluid, the surge pressure must be under the maximum operating pressure. If the surge pressure exceeds the maximum operating pressure, it will result in damage to fittings and tubing.

Furthermore, abnormal temperature rise caused by adiabatic compression may result in the tubing bursting.

Note 2) Do not use this product in a manner in which the tubing is not fixed.

Observe the lesser value of the maximum operating pressure between the tubing and fittings.

A material change over a long duration or due to high-temperature may cause leakage. Perform periodic maintenance and replace with a new product immediately when abnormalities are detected.

(Refer to Maintenance in the TD/TID series Precautions.)

For fluoropolymer fittings, refer to Precautions on pages 71 and 72.

Note 3) TD0425, TD1075 and TD1209 are not available because of different internal diameters.

Note 4) The minimum bending radius is the representative value measured as shown in the left figure.

• Use a tube above the recommended minimum bending radius.

• The tubing may be bent if used under the recommended minimum bending radius. Therefore, refer to the refraction value and make sure that the tubing is not bent or flattened.

• Please note that the refraction value is not warranted because of the value when 2R is measured by the method in the left figure if the tubing is bent or flattened, etc.

How to Order

Metric size

TD0425 - 10

Tubing model

Length per roll

Symbol	Length
10	10 m roll
20	20 m roll

Fluorine ion elution ^{Note 4)}

Type	Fluorine ion
Amount of elution	0.7 (µg/g)

Cut the fluoropolymer tube into 15 g and clean it with pure water. After letting the 15 m² of 25% methyl alcohol elute for 24 hours at the room temperature, dilute the elute with ultrapure water. In accordance with the dissolution method, carry out the quantitative study of fluorine ions.

Metal ion elution ^{Note 4)}

Kind	Al	Fe	Ni	Na	Ca
Amount of elution	0.1 or less	0.1 or less	0.1 or less	0.1	0.1 or less

Clean the inside of fluoropolymer tube with ultrapure water. Weight out about 20 g of ultrapure hydrofluoric acid (48%) and pull in the tube, and then cover both sides of the tube for a week at the room temperature. Dilute the elute with ultrapure water. In accordance with the dissolution method, carry out the quantitative study of Al, Fe, Ni, Na and Ca.

Note 4) The values in the table are not warranted, but the measured values.

Soft Fluoropolymer Tubing Inch Size Series TID



Flexibility: Improved by approx. 20%

* SMC comparison (Fluoropolymer tubing, Series TL/TIL)

Compatible with the Food Sanitation Law

- Compatible with the test conforming to the Food Sanitation Law based on the 370th notice given by the Ministry of Health and Welfare in 1959.
- Compatible with the §177-1550 dissolution test approved by FDA (Food and Drug Administration).

Operating Temperature: Max. 260°C

It varies depending on the operating pressure. Refer to the graph for the maximum operating pressure.

How to measure the minimum bending radius



Bend the tubing into the U-form at a temperature of 20°C. Fix one end and close loop gradually. Measure 2R when the deformed ratio of the tubing diameter at bending reaches 5%.

Model/Specifications

Size		Inch size				
Model		TID01	TID05	TID07	TID11	TID13
Tubing O.D.	inch	1/8"	3/16"	1/4"	3/8"	1/2"
	mm	3.18	4.75	6.35	9.53	12.7
Tubing I.D.	inch	0.086"	0.124" (1/8")	0.156" (5/32")	0.25" (1/4")	0.374" (3/8")
	mm	2.18	3.15	3.95	6.33	9.5
Roll	8m	●	●	●	●	●
	16m	●	●	●	●	●
Color		Translucent (material color)				
Applicable fluid		Refer to the applicable fluid in page 76.				
Fluid ^{Note 1)}		Air, Water, Inert gas				
Applicable fittings ^{Note 2)}		Fluoropolymer fitting: Series LQ1, LQ2, LQ3				
Max. operating pressure (MPa)	20°C	1.4	1.4	1.6	1.4	0.9
	100°C	0.7	0.7	0.9	0.7	0.5
	200°C	0.35	0.35	0.45	0.35	0.25
	260°C	0.2	0.2	0.23	0.2	0.15
Min. bending radius (mm) ^{Note 3)}	Recommended radius	15	20	25	40	75
	Refraction value	9	10	15	23	42
Max. operating temperature (fixed usage)		260°C				
Material		Modified PTFE (Polytetrafluoroethylene resin)				

Note 1) When using a liquid fluid, the surge pressure must be under the maximum operating pressure. If the surge pressure exceeds the maximum operating pressure, it will result in damage to fittings and tubing. Furthermore, abnormal temperature rise caused by adiabatic compression may result in the tubing bursting.

Note 2) Do not use this product in a matter in which the modified PTFE tubing is not fixed.

Observe the lesser value of the maximum operating pressure between the tubing and fittings. A material change over a long duration or due to high-temperature may cause leakage. Perform periodic maintenance and replace with a new product immediately when abnormalities are detected. (Refer to Maintenance in the TD/TID series Precautions.)

For fluoropolymer fittings, refer to Precautions on pages 71 and 72.

Note 3) The minimum bending radius is the representative value measured as shown in the left figure.

- Use a tube above the recommended minimum bending radius.
- The tubing may be bent if used under the recommended minimum bending radius. Therefore, refer to the refraction value and make sure that the tubing is not bent or flattened.
- Please note that the refraction value is not warranted because of the value when 2R is measured by the method in the left figure if the tubing is bent or flattened, etc.

Maximum Operating Pressure

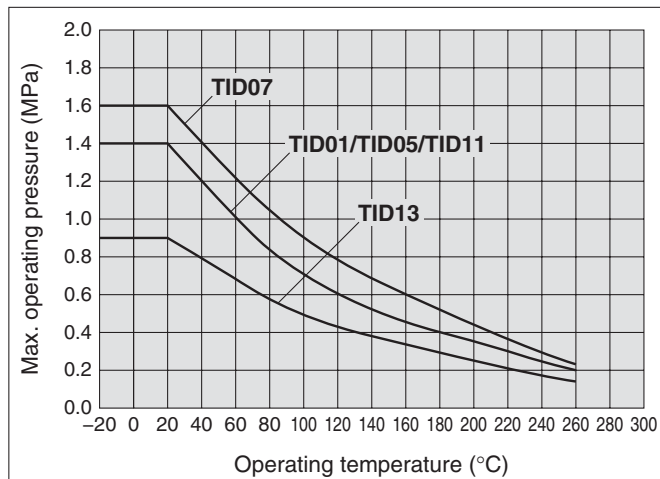

How to Order

Inch size

TID01 - 8

Tubing model

Length per roll

Symbol	Length
8	25 ft (8 m) roll
16	50 ft (16 m) roll

Fluorine ion elution ^{Note 4)}

(µg/g)

Type	Fluorine ion
Amount of elution	0.7

Cut the fluoropolymer tube into 15 g and clean it with pure water. After letting the 15 ml of 25% methyl alcohol elute for 24 hours at the room temperature, dilute the elute with ultrapure water. In accordance with the dissolution method, carry out the quantitative study of fluorine ions.

Metal ion elution ^{Note 4)}

(ng/cm²)

Kind	Al	Fe	Ni	Na	Ca
Amount of elution	0.1 or less	0.1 or less	0.1 or less	0.1	0.1 or less

Clean the inside of fluoropolymer tube with ultrapure water. Weight out about 20 g of ultrapure hydrofluoric acid (48%) and pull in the tube, and then cover both sides of the tube for a week at the room temperature. Dilute the elute with ultrapure water. In accordance with the dissolution method, carry out the quantitative study of Al, Fe, Ni, Na and Ca.

Note 4) The values in the table are not warranted, but the measured values.



Applicable Fluid List

Chemical resistance of Fluoropolymer Super PFA, modified PTFE material

Chemicals in the list below are chemically inert ^{Note)} to Super PFA, modified PTFE material. Possible physical effects may occur such as penetration and swelling due to temperature, pressure and chemical concentration. To use Super PFA, modified PTFE tube in a chemical environment, tests should be performed with the same environment to ensure no problem occurs with operating environment.

1,1,1-Trichloroethane	Formic acid	Trichloroethylene
1,1,2-Trichloroethane	Ethyl formate	Trichloroacetic acid
1,2,3-Trichloropropane	Propyl formate	Toluene
1,2-Dichlorobutane	Methyl formate	Naphtha
2,4-Dichlorotoluene	Xylene	Carbon dioxide
2-chloropropane	Glycol	Nitrogen dioxide
2-nitro-2-methylpropane	Glycerine	Nitrobenzene
2-nitrobutanol	Cresol	Nitromethane
Pentabasic benzamide	Chromic acid	Carbon disulfide
Hydrochlorofluorocarbon-22	Chloracetic acid	Piperidine
N-octadecanol	Chlorosulfonic acid	Pyridine
N-butylamine	Chloroform	Pyrogallol
o-chlorotoluene	Paraffinum liquidum	Phenol
Isobutyl adipate	Acetate	Butanol
Acetyl chloride	Amyl acetate	Phthalic acid
Acetophenone	Ethyl acetate	Hydrofluoric acid
Acetone	Potassium	Furan
Aniline	Butyl acetate	Ethyl propionate
Sulfurous acid gas	Propyl acetate	Propyl propionate
Allyl chloride	Methyl acetate	Methylpropionate
Benzoic acid	Salicylic acid	Propylene chloride
Ammonium	Sodium hypochlorite	Bromobenzene
Sulfur	Diisobutyl ketone	Hexachlorethane
Isoamyl alcohol	Diethylamine	Hexane
Isooctane	Carbon tetrachloride	Heptane
Ethanol	Dioxane	Benzyl alcohol
Ethyl ether	Cyclohexanone	Benzaldehyde
Ethylene glycol	Cyclohexane	Benzine
Ethylene chloride	Dichloroethylene	Benzoyl chloride
Ethylenediamine	Dichloropropylene	Benzonitrile
Zinc chloride	Dibutyl phthalate	Pentachloroethane
Aluminum chloride	Dimethyl ether	Boric acid
Ammonium chloride	Dimethylsulfoxide	Sodium boric acid
Calcium chloride	Dimethylformamide	Formaldehyde
Ferrous chloride	Hydrobromic acid	Acetic anhydride
Mercuric chloride	Potassium dichromate	Methanol
Stannous chloride	Bromine	Methyl ether
Ferric chloride	DI water (Pure water)	Methyl ethyl ketone
Cupric chloride	Nitric acid	Methylene chloride
Sodium chloride	Ammonium hydroxide	Ethyl butyrate
Magnesium chloride	Potassium hydroxide	Methyl butyrate
Hydrochloric acid	Sodium hydroxide	Hydrogen sulfide
Chlorine	Soap, detergent	Sulphuric acid
Aqua regia	Diethyl carbonate	Zinc sulfate
Ozone	Sodium carbonate	Ammonium sulfate
Oleic acid	Tetrachloroethane	Ferrous sulfate
Perchlorate	Tetrachloroethylene	Copper sulfate
Hydrogen peroxide	Tetrahydrofuran	Phosphoric acid
Natrium peroxide	Tetrabromoethane	Sodium phosphate
Gasoline	Triethanolamine	
Potassium permanganate	Triethylamine	

Note) "Chemically inert" means – not to cause any chemical reaction.

LQ1

LQ3

LVN

LQHB

TL/TIL

TD/TID

TH/TIH

Applicable Fluid

Precautions

FEP Tubing (Fluoropolymer) Metric Size Series TH

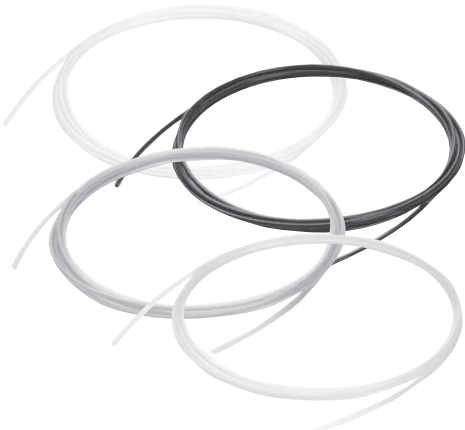

Operating Temperature: Max. 200°C
It varies depending on the operating pressure. Refer to the graph for the maximum operating pressure.

Compatible with the Food Sanitation Law

- Compatible with the test conforming to the Food Sanitation Law based on the 370th notice given by the Ministry of Health and Welfare in 1959.
- Compatible with the §177-1550 dissolution test approved by FDA (Food and Drug Administration).

How to measure the minimum bending radius.

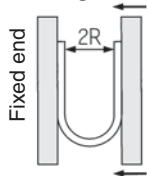

At a temperature of 20°C, bend the tubing into a U shape. Fix one end and gradually move the other end closer. Measure 2R at the point where the outside diameter's rate of change is 5%.

Max. Operating Pressure

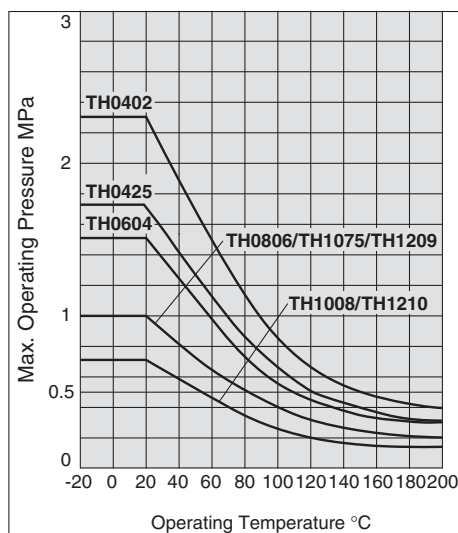

Note) The maximum operating pressure varies dependant on the I.D. bore size even if the O.D. is the same.

Series

● -20 m roll □ -100 m roll

Model	Metric size							
	TH0402	TH0425	TH0604	TH0806	TH1075	TH1008	TH1209	TH1210
Tubing O.D. (mm)	4	4	6	8	10	10	12	12
Tubing I.D. (mm)	2	2.5	4	6	7.5	8	9	10

Color	Symbol	TH0402	TH0425	TH0604	TH0806	TH1075	TH1008	TH1209	TH1210
Translucent	N	●	●	●	●	●	●	●	●
Red (Translucent)	R	●	●	●	●	●	●	●	●
Blue (Translucent)	BU	●	●	●	●	●	●	●	●
Black (Opaque)	B	●	●	●	●	●	●	●	●

Inch nominal size: 5/32" (for TH0402, TH0425) and 5/16" (for TH0604, TH0806, TH1075, TH1008, TH1209, TH1210)

Specifications

Fluid	Air, Water ^{Note 1)} , Inert gas							
Applicable fittings ^{Note 2)}	One-touch fittings, Insert fittings Fluoropolymer fittings: Series LQ1, LQ2, LQ3 ^{Note 3)} Miniature fittings: Series M, MS (Hose nipple type)							
Max. operating pressure (MPa)	20°C	2.3	1.7	1.5	1	0.7	1	0.7
	100°C	0.85	0.6	0.55	0.4	0.25	0.4	0.25
	200°C	0.4	0.3	0.3	0.2	0.1	0.2	0.1
Refer to below "Max. Operating Pressure."								
Min. bending radius (mm) ^{Note 4)}	15	20	35	60	95	100	130	
Operating temperature	Air, Inert gas: -20 to 200°C Water: 0 to 100°C (No freezing)							
Material	FEP (Fluorinated Ethylene Propylene Resin)							

Note 1) When using a fluid in liquid form, the surge pressure must not exceed the maximum operating pressure. A surge pressure higher than the maximum operating pressure can cause breakage of the fittings, or rupture of the tubing. Furthermore, an abnormal temperature increase due to adiabatic compression can also result in ruptured tubing.

Note 2) Do not use in locations where the FEP tubing will move.

Be sure to operate under the maximum operating pressure conditions using the lower maximum operating specification of either the tubing or fittings.

After long term use or under high temperatures, some fittings leakage may occur due to material deterioration with age. Perform periodic inspections, and if any leakage is detected, replace with a new product immediately.

When the insert and miniature fittings are used over extended periods of time, it may cause leakage due to the material deterioration of age. In such a case, give an additional tightening to the tube connection part. If leakage still occurs after giving an additional tightening, replace the fitting with a new product. For fluoropolymer fittings, refer to Precautions on pages 71 and 72. Pay special attention to the applicable tubing sizes.

Note 3) TH0402, TH0425, TH1075 and TH1209 are not available because of different internal diameters.

Note 4) Minimum bending radius is measured as shown left as representative values.

Allow extra length when piping since the tubing may crush if bent more than the min. bending radius.

How to Order

Metric size
TH0604 N - 20

Indication of tubing model: TH0604
Color indication: N
Length per roll: 20

Symbol	Color
N	Translucent
R	Red (Translucent)
BU	Blue (Translucent)
B	Black (Opaque)

Symbol	Roll size
20	20 m roll
100 ^{Note)}	100 m roll

Note) 100 m roll is available with translucent (color indication: N) only.

FEP Tubing (Fluoropolymer)

Inch Size

Series *TIH*

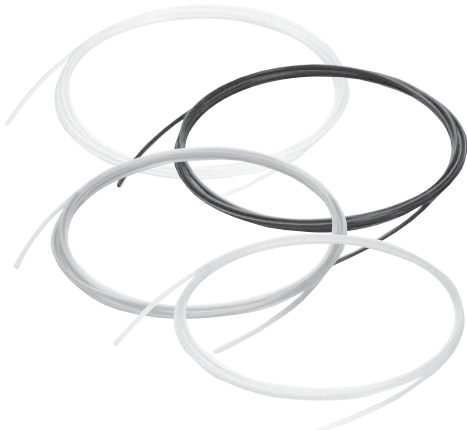

Operating Temperature: Max. 200°C

It varies depending on the operating pressure. Refer to the graph for the maximum operating pressure.

Compatible with the Food Sanitation Law

- Compatible with the test conforming to the Food Sanitation Law based on the 370th notice given by the Ministry of Health and Welfare in 1959.
- Compatible with the §177-1550 dissolution test approved by FDA (Food and Drug Administration).

How to measure the minimum bending radius.

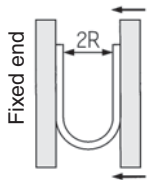

At a temperature of 20°C, bend the tubing into a U shape. Fix one end and gradually move the other end closer. Measure 2R at the point where the outside diameter's rate of change is 5%.

Max. Operating Pressure

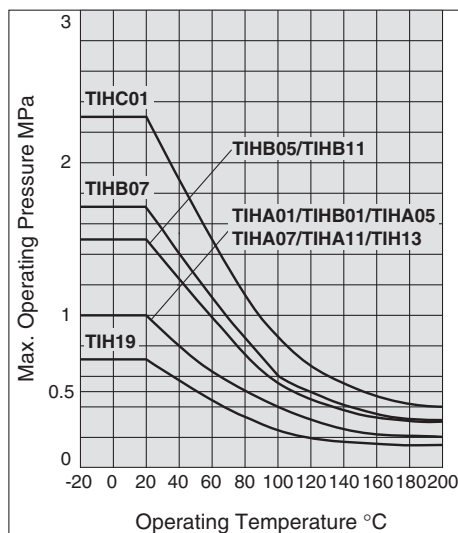

Note) The maximum operating pressure varies dependent on the I.D. bore size even if the O.D. is the same.

Series

●-50ft (16m) roll □-100ft (33m) roll

		Inch size										
Model		TIHA01	TIHB01	TIHC01	TIHA05	TIHB05	TIHA07	TIHB07	TIHA11	TIHB11	TIH13	TIH19
Tubing O.D.	inch	1/8"			3/16"		1/4"		3/8"		1/2"	3/4"
	mm	3.18			4.75		6.35		9.53		12.7	19.05
Tubing I.D.	inch	0.093"	0.086"	0.065"	0.137"	0.124" (1/8")	0.18"	0.156" (5/32")	0.275"	0.25" (1/4")	0.374" (3/8")	0.624" (5/8")
	mm	2.36	2.18	1.65	3.48	3.15	4.57	3.95	6.99	6.33	9.5	15.85

Color	Symbol	TIHA01	TIHB01	TIHC01	TIHA05	TIHB05	TIHA07	TIHB07	TIHA11	TIHB11	TIH13	TIH19
Translucent	N	●	●	●	●	●	●	●	●	●	●	●
Red (Translucent)	R	●	●	●	●	●	●	●	●	●	●	●
Blue (Translucent)	BU	●	●	●	●	●	●	●	●	●	●	●
Black (Opaque)	B	●	●	●	●	●	●	●	●	●	●	●

Specifications

Fluid	Air, Water ^{Note 1)} , Inert gas										
Applicable fittings ^{Note 2)}	One-touch fittings, Fluoropolymer fittings: Series LQ1, LQ2, LQ3 ^{Note 3)}										
Max. operating pressure (MPa)	20°C	1	2.3	1	1.5	1	1.7	1	1.5	1	0.7
	100°C	0.4	0.85	0.4	0.55	0.4	0.6	0.4	0.55	0.4	0.25
	200°C	0.2	0.4	0.2	0.3	0.2	0.3	0.2	0.3	0.2	0.1
Refer to below "Max. Operating Pressure."											
Min. bending radius (mm) ^{Note 4)}	25	20	10	35	25	55	35	85	60	95	220
Operating temperature	Air, Inert gas: -20 to 200°C Water: 0 to 100°C (No freezing)										
Material	FEP (Fluorinated Ethylene Propylene Resin)										

Note 1) When using a fluid in liquid form, the surge pressure must not exceed the maximum operating pressure. A surge pressure higher than the maximum operating pressure can cause breakage of the fittings, or rupture of the tubing. Furthermore, an abnormal temperature increase due to adiabatic compression can also result in ruptured tubing.

Note 2) Do not use in locations where the FEP tubing will move.

Be sure to operate under the maximum operating pressure conditions using the lower maximum operating specification of either the tubing or fittings.

After long term use or under high temperatures, some fittings leakage may occur due to material deterioration with age. Perform periodic inspections, and if any leakage is detected, replace with a new product immediately.

When the insert and miniature fittings are used over extended periods of time, it may cause leakage due to the material deterioration of age. In such a case, give an additional tightening to the tube connection part. If leakage still occurs after giving an additional tightening, replace the fitting with a new product. For fluoropolymer fittings, refer to Precautions on pages 71 and 72. Pay special attention to the applicable tubing sizes.

Note 3) TIHA01, TIHC01, TIHA05, TIHA07 AND TIHA11 are not available because of different internal diameters.

Note 4) Minimum bending radius is measured as shown left as representative values.

Allow extra length when piping since the tubing may crush if bent more than the min. bending radius.

How to Order

Inch size

TIHA01 N - 16

Indication of tubing model → **TIHA01** Color indication → **N** Length per roll → **16**

Symbol	Color
N	Translucent
R	Red (Translucent)
BU	Blue (Translucent)
B	Black (Opaque)

Symbol	Roll size
16	50ft (16m) roll
33 ^{Note)}	100ft (33m) roll

Note) 100ft (33m) roll is available with translucent (color indication: N) only.



Applicable Fluid List

Chemical Resistance of Fluoropolymer FEP Material

Chemicals in the list below are chemically inert ^{Note)} to FEP material, however physical properties may be effected by temperature or pressure change.

Please make sure that operating conditions do not cause problems since the use of FEP tubing under chemical environment is unsecured.

2-nitro-2-methyl propanol	Chloroform	Nitromethane
2-nitrobutanol	Paraffinum liquidum	Perchloroethylene
Pentabasic benzamide	Allyl acetate	Perphloroxylene
N-butylamine	Ethyl acetate	Unsymmetrical dimethylhydrazine
N-octadecanol	Potassium	Hydrazine
N-butyl acetate	Butyl acetate	Pinene
O-cresol	Sodium hypochlorite	Piperidine
Di-isobutyl adipate	Carbon tetrachloride	Glacial acetic acid (Acetic acid)
Acetophenone	Dioxane	Pyridine
Acetone	Cyclohexanone	Phenol
Alniline	Cyclohexane	Phthalic acid
Abietic acid	Dimethyl ether	Dybutyl phthalate
Sulfuric chloride	Dimethylsulfoxide	Dimethyl phthalate
Isooctane	Dimethylformamide	Hydrofluoric acid
Liquid ammonia	Bromine	Naphthalene fluoride
Ethyl alcohol	DI water (Pure water)	Nitrobenzene fluoride
Ethyl ether	Nitric acid	Furan
Ethylene glycol	Mercury	Hexachlorethane
Ethylenediamine	Ammonium hydroxide	Hexane
Zinc chloride	Potassium hydroxide	Ethyl hexanoate
Aluminum chloride	Sodium hydroxide	Phenylcarbinol
Ammonium chloride	Cetane	Benzaldehyde
Calcium chloride	Soap, detergent	Benzonitrile
Sulfuric chloride	Dibutyl sebacate	Borax
Iron chloride (III)	Diethyl carbonate	Boric acid
Benzoyl chloride	Tetrachloroethylene	Formic aldehyde (Formalin)
Magnesium chloride	Tetrahydrofuran	Acrylic anhydride
Hydrochloric acid	Tetrabromoethane	Acetic anhydride
Chlorine (absolute)	Triethanolamine	Methacrylic acid
Aqua regia	Trichloroethylene	Allyl methacrylate
Ozone	Trichloroacetic acid	Vinyl methacrylate
Hydrogen peroxide	Toluene	Methyl alcohol
Natrium peroxide	Naphtha	Methyl ethyl ketone
Gasoline	Naphthalene	Methylene chloride
Permanganate	Naphthol	Sulphuric acid
Formic acid	Lead	Phosphoric acid
Xylene	Carbon dioxide	Iron phosphate (III)
Chromic acid	Nitrogen dioxide	Tri-n-butyl phosphate
Chlorosulfonic acid	Nitrobenzene	Tricresyl phosphate

Note) "Chemically inert" means – not to cause any chemical reaction.



Series TL/TIL/TD/TID/TH/TH Tubing/Precautions

Be sure to read before handling.

Selection

⚠ Warning

1. Confirm the specifications.

Products represented in this catalogue are designed only for use in compressed air systems (including vacuum). Do not operate at pressures or temperatures, etc., beyond the range of specifications, as this can cause damage or malfunction. (Refer to the specifications.)

2. In case of using the product for medical care

This product is designed for use with compressed air system applications for medical care purposes. Do not use in contact with human bodily fluids, body tissues or transfer applications to a human living body.

⚠ Caution

1. Do not use in locations where the connecting threads and tubing connection will slide or rotate.

The connecting threads and tubing connection will come apart under these conditions.

2. Use tubing at or above the minimum bending radius. Using below the minimum bending radius can cause breakage or flattening of the tubing.

3. Never use the tubing for anything flammable, explosive or toxic such as gas, fuel gas, or cooling mediums etc.

Because the contents may penetrate outward.

4. Use the fittings applicable to the tubing size.

Mounting

⚠ Caution

1. Confirm model no., size, etc. before installing.

Check tubing for damage, gouges, cracks, etc.

2. When tubing is connected, consider factors such as changes in the tubing length due to pressure, and allow sufficient leeway.

3. Do not apply unnecessary forces such as twisting, pulling, moment loads, etc. on fittings or tubing.

This will cause damage to fittings and will crush, burst or release tubing.

4. Mount so that tubing is not damaged due to tangling and abrasion.

This can cause flattening, bursting or disconnection of tubing, etc.

Piping

⚠ Caution

1. Preparation before piping

Before piping is connected, it should be thoroughly blown out with air (flushing) or washed to remove chips, cutting oil and other debris from inside the pipe. Not allowing chips of the piping thread or the seal material to go in.

Air Supply

⚠ Warning

1. Types of fluid

This product is designed for use with compressed air.

2. In case of excessive condensation

Excessive condensation in a compressed air system may cause pneumatic equipment to malfunction. Installation of an air dryer, water separator before filter is recommended.

3. Drain flushing

If condensation in the drain bowl is not emptied on a regular basis, the bowl will overflow and allow the condensation to enter the compressed air lines. It causes malfunction of pneumatic devices.

If the drain bowl is difficult to check and remove, installation of a drain bowl with an auto drain option is recommended.

For compressed air quality, refer to SMC's "Air Cleaning Equipment" catalogue.

Operating Environment

⚠ Warning

1. Do not use in locations having an explosive atmosphere.

2. Do not operate in locations where vibration or impact occurs.

3. In locations near heat sources, block off radiated heat.

Maintenance

⚠ Caution

1. Reform periodic inspections to check the following problems and replace tubing, if necessary.

- 1) Cracks, gouges, wearing, corrosion
- 2) Air leakage
- 3) Twists or crushing of tubing
- 4) Hardening, deterioration, softening of tubing

2. Do not repair or patch the replaced tubing or fittings for reuse.

3. When using insert or miniature fittings over a long period, some leakage may occur due to age deterioration of the materials. If any leakage is detected, correct the problem by additional tightening.

If tightening becomes ineffective, replace the fittings with a new product immediately.

LQ1

LQ3

LVN

LQHB

TL/TIL

TD/TID

TH/THI

Applicable Fluid

Precautions

Safety Instructions

These safety instructions are intended to prevent hazardous situations and/or equipment damage. These instructions indicate the level of potential hazard with the labels of “**Caution**,” “**Warning**” or “**Danger**.” They are all important notes for safety and must be followed in addition to International Standards (ISO/IEC)*1, and other safety regulations.

Caution: **Caution** indicates a hazard with a low level of risk which, if not avoided, could result in minor or moderate injury.

Warning: **Warning** indicates a hazard with a medium level of risk which, if not avoided, could result in death or serious injury.

Danger: **Danger** indicates a hazard with a high level of risk which, if not avoided, will result in death or serious injury.

- *1) ISO 4414: Pneumatic fluid power – General rules relating to systems.
ISO 4413: Hydraulic fluid power – General rules relating to systems.
IEC 60204-1: Safety of machinery – Electrical equipment of machines.
(Part 1: General requirements)
ISO 10218-1: Manipulating industrial robots - Safety.
etc.

Warning

1. The compatibility of the product is the responsibility of the person who designs the equipment or decides its specifications.

Since the product specified here is used under various operating conditions, its compatibility with specific equipment must be decided by the person who designs the equipment or decides its specifications based on necessary analysis and test results. The expected performance and safety assurance of the equipment will be the responsibility of the person who has determined its compatibility with the product. This person should also continuously review all specifications of the product referring to its latest catalogue information, with a view to giving due consideration to any possibility of equipment failure when configuring the equipment.

2. Only personnel with appropriate training should operate machinery and equipment.

The product specified here may become unsafe if handled incorrectly. The assembly, operation and maintenance of machines or equipment including our products must be performed by an operator who is appropriately trained and experienced.

3. Do not service or attempt to remove product and machinery/equipment until safety is confirmed.

- The inspection and maintenance of machinery/equipment should only be performed after measures to prevent falling or runaway of the driven objects have been confirmed.
- When the product is to be removed, confirm that the safety measures as mentioned above are implemented and the power from any appropriate source is cut, and read and understand the specific product precautions of all relevant products carefully.
- Before machinery/equipment is restarted, take measures to prevent unexpected operation and malfunction.

4. Contact SMC beforehand and take special consideration of safety measures if the product is to be used in any of the following conditions.

- Conditions and environments outside of the given specifications, or use outdoors or in a place exposed to direct sunlight.
- Installation on equipment in conjunction with atomic energy, railways, air navigation, space, shipping, vehicles, military, medical treatment, combustion and recreation, or equipment in contact with food and beverages, emergency stop circuits, clutch and brake circuits in press applications, safety equipment or other applications unsuitable for the standard specifications described in the product catalogue.
- An application which could have negative effects on people, property, or animals requiring special safety analysis.
- Use in an interlock circuit, which requires the provision of double interlock for possible failure by using a mechanical protective function, and periodical checks to confirm proper operation.

Caution

1. The product is provided for use in manufacturing industries.

The product herein described is basically provided for peaceful use in manufacturing industries.

If considering using the product in other industries, consult SMC beforehand and exchange specifications or a contract if necessary.

If anything is unclear, contact your nearest sales branch.

Limited warranty and Disclaimer/ Compliance Requirements

The product used is subject to the following “Limited warranty and Disclaimer” and “Compliance Requirements”.

Read and accept them before using the product.

Limited warranty and Disclaimer

- The warranty period of the product is 1 year in service or 1.5 years after the product is delivered.*2)
Also, the product may have specified durability, running distance or replacement parts. Please consult your nearest sales branch.
- For any failure or damage reported within the warranty period which is clearly our responsibility, a replacement product or necessary parts will be provided.
This limited warranty applies only to our product independently, and not to any other damage incurred due to the failure of the product.
- Prior to using SMC products, please read and understand the warranty terms and disclaimers noted in the specified catalogue for the particular products.

*2) Vacuum pads are excluded from this 1 year warranty.

A vacuum pad is a consumable part, so it is warranted for a year after it is delivered.
Also, even within the warranty period, the wear of a product due to the use of the vacuum pad or failure due to the deterioration of rubber material are not covered by the limited warranty.

Compliance Requirements

- The use of SMC products with production equipment for the manufacture of weapons of mass destruction (WMD) or any other weapon is strictly prohibited.
- The exports of SMC products or technology from one country to another are governed by the relevant security laws and regulations of the countries involved in the transaction. Prior to the shipment of a SMC product to another country, assure that all local rules governing that export are known and followed.

Safety Instructions

Be sure to read “Handling Precautions for SMC Products” (M-E03-3) before using.

SMC Corporation (Europe)

Austria	☎+43 (0)226222800	www.smc.at	office@smc.at
Belgium	☎+32 (0)33551464	www.smcpcneumatics.be	info@smcpcneumatics.be
Bulgaria	☎+359 (0)2807670	www.smc.bg	office@smc.bg
Croatia	☎+385 (0)13707288	www.smc.hr	office@smc.hr
Czech Republic	☎+420 541424611	www.smc.cz	office@smc.cz
Denmark	☎+45 70252900	www.smc.dk.com	smc@smcdk.com
Estonia	☎+372 6510370	www.smcpcneumatics.ee	smc@smcpcneumatics.ee
Finland	☎+358 207513513	www.smc.fi	smc@smc.fi
France	☎+33 (0)164761000	www.smc-france.fr	promotion@smc-france.fr
Germany	☎+49 (0)61034020	www.smc-pneumatik.de	info@smc-pneumatik.de
Greece	☎+30 210 2717265	www.smchellas.gr	sales@smchellas.gr
Hungary	☎+36 23511390	www.smc.hu	office@smc.hu
Ireland	☎+353 (0)14039000	www.smcpcneumatics.ie	sales@smcpcneumatics.ie
Italy	☎+39 0292711	www.smcitalia.it	mailbox@smcitalia.it
Latvia	☎+371 67817700	www.smc.lv	info@smc.lv

Lithuania	☎+370 5 2308118	www.smc.lt	info@smc.lt
Netherlands	☎+31 (0)205318888	www.smcpcneumatics.nl	info@smcpcneumatics.nl
Norway	☎+47 67129020	www.smc-norge.no	post@smc-norge.no
Poland	☎+48 (0)222119616	www.smc.pl	office@smc.pl
Portugal	☎+351 226166570	www.smc.eu	postpt@smc.smc.es
Romania	☎+40 213205111	www.smcromania.ro	smcromania@smcromania.ro
Russia	☎+7 8127185445	www.smc-pneumatik.ru	info@smc-pneumatik.ru
Slovakia	☎+421 (0)413213212	www.smc.sk	office@smc.sk
Slovenia	☎+386 (0)73885412	www.smc.si	office@smc.si
Spain	☎+34 902184100	www.smc.eu	post@smc.smc.es
Sweden	☎+46 (0)86031200	www.smc.nu	post@smc.nu
Switzerland	☎+41 (0)523963131	www.smc.ch	info@smc.ch
Turkey	☎+90 212 489 0 440	www.smcpcnomatik.com.tr	info@smcpcnomatik.com.tr
UK	☎+44 (0)845 121 5122	www.smcpcneumatics.co.uk	sales@smcpcneumatics.co.uk