

## PFM7, 2-Color Display, Digital Flow Switch, Integrated Display

### PFM750-01L-F

Datasheet

### General series information

- Compact and light weight.
- Digital 2 color indication.
- Elbow piping can be used.
- Integrated flow adjustment valve.
- Several combinations are possible.
- Different mounting methods are possible.

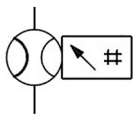

Flow meter with digital display

### Standard specifications

Flow Rate Range	50 [1 to 50 (25 for CO <sub>2</sub> ) l/min]
Flow Adjustment Valve	None
Port Size	01 (Rc1/8)
Piping Entry Direction	L (Bottom Side)
Output Specification	F [1 PNP Outputs + Analog (4 to 20 mA)]
Unit Specification	Unit Switching Function
Instruction Manual	With Instruction Manual
Calibration Certificate	None
Connector	Lead Wire w/Connector (2 m)
Option	None
Made to Order	None
Maximum operating pressure	750 kPa
Minimum operating pressure	-100 kPa
Proof pressure	1 MPa
Maximum ambient temperature	Operating: 50 °C / Stored: 60°C
Minimum ambient temperature	Operating: 0 °C / Stored: -10 °C (with no freezing and condensation)

Approvals	CE
Flow rate	1 - 50 l/min (Dry air, N2, Ar) / 1 - 25 l/min (CO2)
Response time	1 s (50 ms, 0.5 s, 2 s can be selected)
Operating humidity range	Operating, Stored: 35 - 85%R.H. (with no condensation)
Internal voltage drop	NPN output: 1 V or less (at 80 mA) / PNP output: 1.5 V or less (at 80 mA)
Current consumption	55 mA or less
Enclosure	IP40
Repeatability	±1%F.S. or less (Fluid: Dry air) / Analogue output accuracy: ±3%F.S. or less
Linearity	Display accuracy: ±3%F.S. or less (Fluid: Dry air) / Analogue output accuracy: ±5%F.S. or less
Applicable fluid	Dry air, N2, Ar, CO2 (Air quality grade is ISO8573.1-1, 1.2 to 1.6.2.)
Rated pressure range	-70 kPa - 750 kPa
Power supply voltage	24 VDC ±10%
Switch output	NPN or PNP open collector output
Maximum load current	80 mA
Flow display range	1 - 52.5 l/min (Dry air, N2, Ar) / 1 - 26.2 l/min (CO2)
Applied voltage	28 VDC (at NPN output)
Vibration resistance	Without orifice: 10 to 500 Hz with a 1.5 mm amplitude or 98 m/s <sup>2</sup> acceleration, in each X, Y, Z direction for 2 hrs, whichever is smaller / With orifice: 10 to 150 Hz with a 1.5 mm amplitude or 19.6 m/s <sup>2</sup> acceleration, in each X, Y, Z direction for 2 hrs, whichever is smaller
Impact resistance	490 m/s <sup>2</sup> in X, Y, Z directions 3 times each
Display	3-digit, 7-segment LED / 2-colour display (Red/Green) / Renewed cycle: 10 times/sec
Indicator light	OUT1: Illuminates when output is turned ON (Green) / OUT2: Illuminates when output is turned ON (Red)
Withstand voltage	1000 VAC for 1 min. between external terminal and case
Insulation resistance	50 MΩ or more (at 500 VDC measured via Megohmmeter) between external terminal and case
Temperature characteristics	±2%F.S. (15 - 35 °C) / ±5%F.S. (0 - 50 °C)
Maximum fluid temperature	50 °C
Minimum fluid temperature	0 °C (with no freezing and condensation)
Accumulated volume per pulse	0.1 l/pulse
Pressure characteristics	±5%F.S. or less (based on 0.35 MPa)
Switch output protection	Short-circuit protection, Overcurrent protection
External input type	No-voltage input (Reed or Solid state)
External input time	Input 30 ms or more
Minimum display unit	0.1 l/min
Display unit	Real-time flow rate l/min, CFM x 10 <sup>-2</sup> / Accumulated flow l, ft <sup>3</sup> x 10 <sup>-1</sup>
Accumulated flow range	Max. 999999 l
Set flow range	1 - 52.5 l/min (Dry air, N2, Ar) / 1 - 26.2 l/min (CO2)
Hysteresis	Variable
Analogue output response time	1.5 s or less (90% response)
Analogue voltage output - Output Impedance	1 - 5 V / 1 kΩ
Analogue current output	4 - 20 mA
Analogue current output - Load Impedance	50 - 600 Ω
Weight	0.105 Kg

# Dimensions

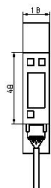
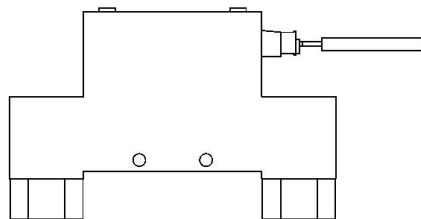
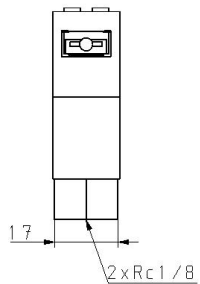
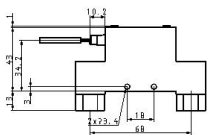
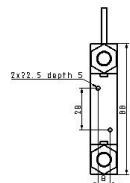

## Constructions

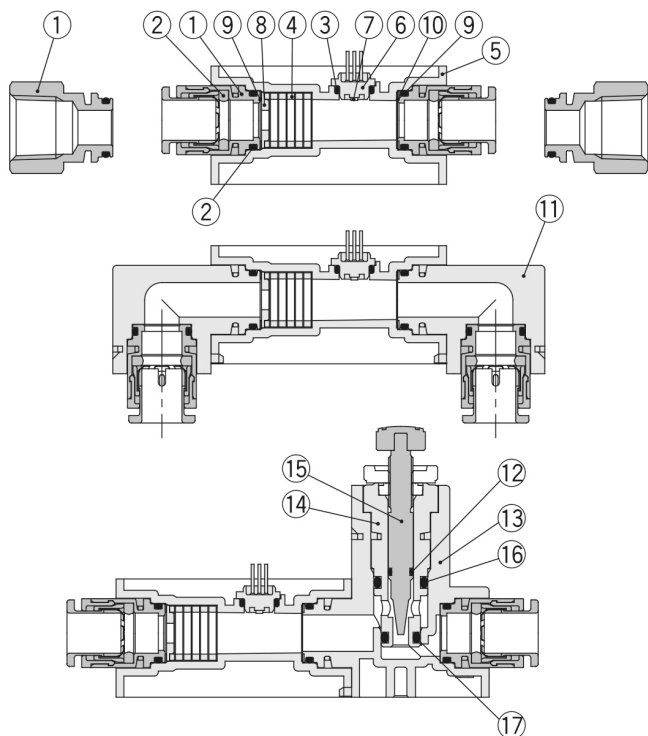

## Component Parts

No.	Description	Material	Note
1	<b>Fitting for piping</b>	Brass	Electroless nickel plated
2	<b>O-ring</b>	FKM	Fluoro coated
3	<b>O-ring</b>	HNBR	Fluoro coated
4	<b>Rectifying module</b>	Stainless steel 304	
5	<b>Body</b>	PBT	
6	<b>Sensor housing</b>	LCP	
7	<b>Sensor chip</b>	Silicon	
8	<b>Orifice</b>	Brass	Electroless nickel plated
9	<b>Seal</b>	FKM	Fluoro coated
10	<b>Mesh</b>	Stainless steel 304	
11	<b>Bottom piping adapter</b>	PBT	
12	<b>O-ring</b>	HNBR	Fluoro coated
13	<b>Flow adjustment valve assembly</b>	PBT	
14	<b>Body B</b>	Brass	Electroless nickel plated
15	<b>Needle</b>	Brass	Electroless nickel plated
16	<b>O-ring</b>	HNBR	Fluoro coated
17	<b>O-ring</b>	HNBR	Fluoro coated

## Additional information

Catalogue	<a href="#">PFM_EU.pdf</a>
Declaration of conformity	<a href="#">DoC_PFx_TFM0005-C.pdf</a> <a href="#">newDoC_PFM_TF1V117EN.pdf</a>
Installation manuals	<a href="#">IM_PFM7_TF2Z077EN.pdf</a>
Operation manuals	<a href="#">OM_PFM7_OMJ0006EN-K.pdf</a>