

AL20-D to AL60-D, Lubricator AL20-F02-D

Datasheet

General series information

- Maximum flow rate up to 15000 l/min (ANR, 0.7MPa).

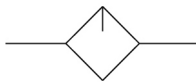

Lubricator

Standard specifications

Body Size	20
Thread	F (G)
Port Size	02 (1/4)
Mounting	w/o Mounting Option
Bowl/Lubricant exhaust port/Flow direction	Polycarbonate Bowl
Pressure Unit	MPa, °C
Pressure medium	Air
Maximum temperature of pressure medium	60 °C
Minimum temperature of pressure medium	-5 °C (with no freezing)
Maximum operating pressure	1.0 MPa
Minimum operating pressure	0.05 MPa
Proof pressure	1.5 MPa
Conform to the European RoHS Directive	Conform
Oil capacity	25 cm ³
Max. Flow rate (inlet pressure = 1.0 MPa)	4000 l/min
MIN_DRIPPING_FLOW	15 l/min
RECOMMENDED_LUBRICANT	Class 1 turbine oil (ISO VG32)
Weight	0.101 Kg

Dimensions

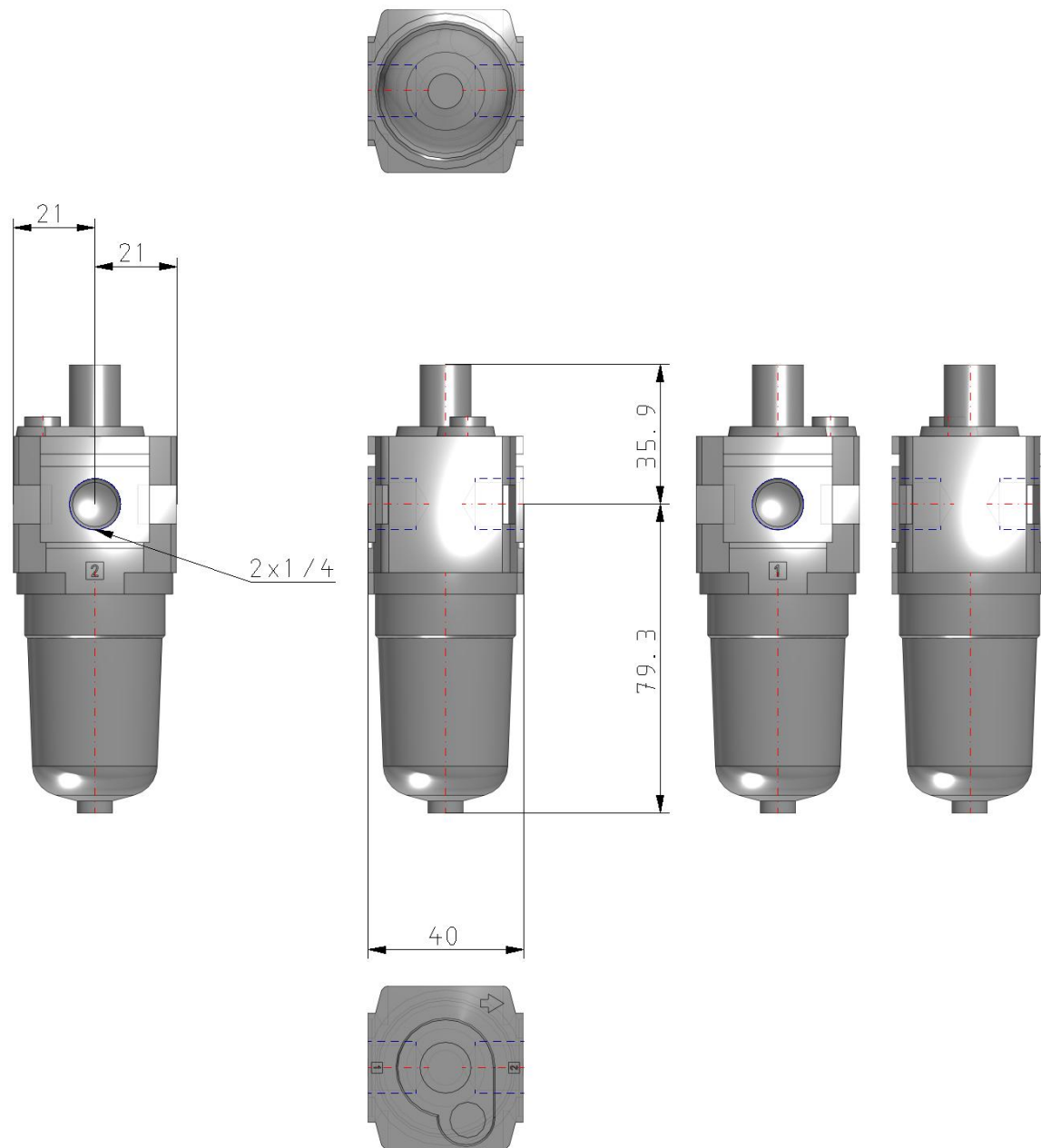

Specifications are subject to change without prior notice and any obligation on the part of the manufacturer.

Additional information

Catalogue

[ACD-D_EU.pdf](#)

Operation manuals

[OM_AL20-60-D_OMX0056EN-B.pdf](#)