

C(D)Q2, Compact Cylinder, Double Acting, Single Rod w/Auto Switch Mounting Groove CQ2A25-10D

Datasheet

Following a review of our popular CQ2 compact cylinder Series our R&D engineers have totally redesigned the complete cylinder range to bring you even more performance benefits and increased cylinder options. The major difference between the new CQ2 range and the old model is the totally redesigned body, which offers improved auto-switch mounting possibilities plus an overall reduction of cylinder weight of between 5 -13% depending on the model. Now, all CQ2 cylinders from Ø 32 to 200mm are designed with slide in grooves which can accommodate auto-switches on all four cylinder sides without the need for auto-switch brackets. And, for smaller bore sizes between Ø 12 and 25mm, slide in grooves have also been integrated in the new body design to accommodate bracket free auto-switches on two surfaces. Designed for use with our simple to set, dual colour, solid state auto-switches, the integrated auto-switch channel ensures total protection against potential accidental damage and improved health and safety benefits during both installation and maintenance procedures.

Magnet	None
Mounting	A (Both Ends Tapped)
Type	Standard
Bore Size	Ø25 mm
Port Thread Type	Rc
Lube-retainer	Without Stable Lubrication Function
Stroke	10
Body Option	Standard [Rod End Female Thread]
Auto Switch Groove	None, also for 12-25 Bore w/o Magnet
Mounting Bolt	None
Rod End Bracket	None
Auto Switch	No Switch
Lead Wire or Prewired Connector	0.5 m or None in the Case of No Switch
Number	2 pcs.
Rod End Options	None
Temperature Resistance	None
Low Speed	None
Made of Stainless Steel	None
Fluororubber Seal	None
Pressure medium	Compressed air
Conform to the European RoHS Directive	Not conform
Numero of pneumatic connections	2 pcs.
Mode of operation of drive	Double acting
Geometric form of the piston rod	Single rod
Weight	0.139 Kg

Dimensions

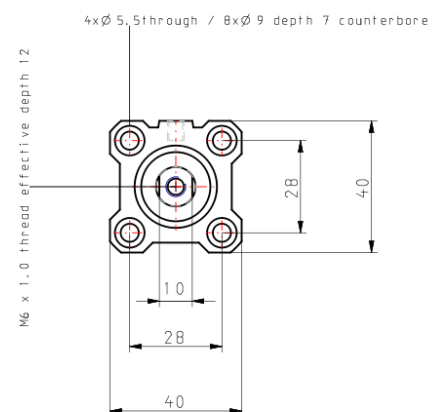
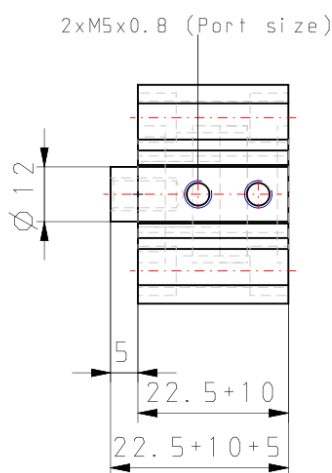

Additional information

Catalogue

[CQ2-Z-B_EU.pdf](#)