

EAV2000/3000/4000/5000 Series, Soft Start-up Valve, European EAV2000-F02-5YO-Q

Datasheet

General series information

- Operating pressure range: 0.2 - 1MPa
- Coil rated voltage: 12, 24VDC;
100, 110 to 120, 200, 220VAC
- Allowable voltage fluctuation: -15% to +10%
of rated voltage
- Ambient & fluid temperature: 0 to 60°C
- Electrical entry: grommet, type D DIN connector,
type Y DIN connector

Standard specifications

Size	2000
Port Size	02 (1/4)
Option	None
Voltage	5 (24VDC)
Lead Wire	YO (Type Y DIN Terminal without Connector)
Surge Suppressor	None
Manual Override	Non-locking Push Style (Flush)
Q	Q (CE Marked)
Pressure medium	Air
Maximum temperature of pressure medium	60 °C
Minimum temperature of pressure medium	0 °C
Maximum operating pressure	1 MPa
Minimum operating pressure	0.2 MPa
Proof pressure	1.5 MPa
Maximum ambient temperature	60 °C

Minimum ambient temperature	0 °C
Pneumatic input connection	G 1/4
Pneumatic output connection	G 1/4
Pneumatic exhaust connection	G 1/4
Flow rate	1089 l/min (ANR)
Type of electrical connector	Type Y (DIN terminal/Without connector)
Manual override	Non-locking push type (flush type)
Weight	0.270 Kg

Dimensions

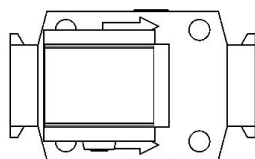
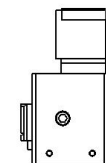
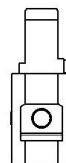
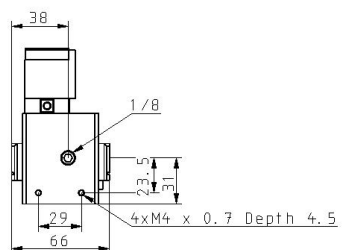
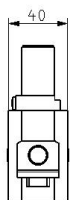
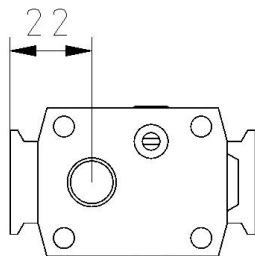

Constructions

Construction

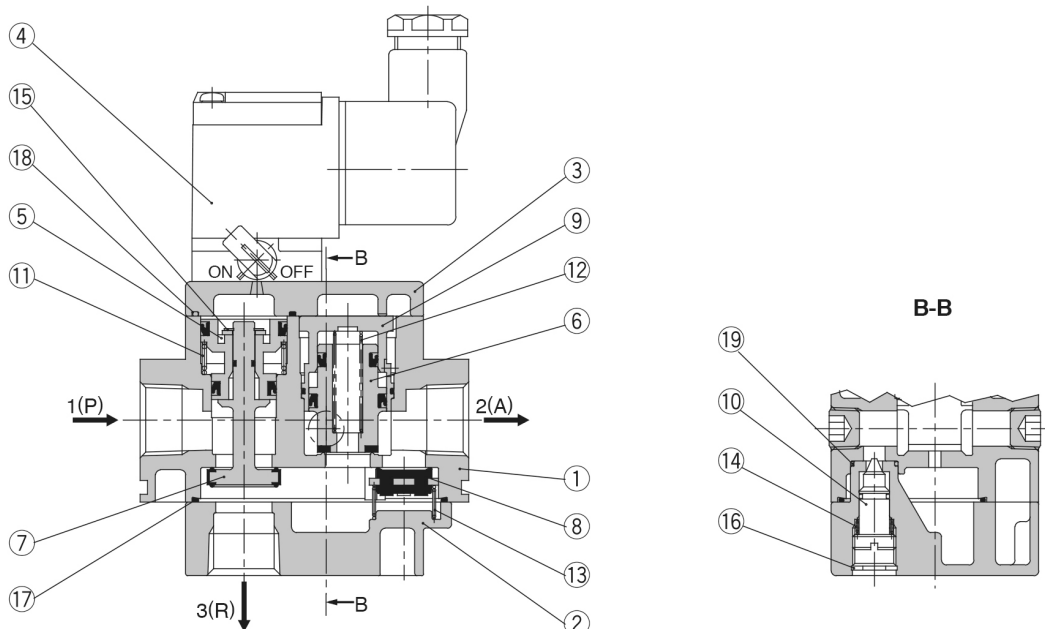

Parts list

No.	Description	Material
1	Body	ADC
2	Cap	ADC
3	Cover	ADC

Replacement parts

No.	Description	Material	Part no.			
			AV2000	AV3000	AV4000	AV5000
4	Pilot valve assembly	—	SF4-□-80*			
5	Piston A assembly	POM, NBR	P424204A	P424304A	P424404A	P424504A
6	Piston B assembly	Brass, NBR (HNBR)	P424205A	P424305A	P424405A	P424505A
7	Main valve assembly	Brass, NBR (HNBR)	P424206A	P424306A	P424406A	P424506A
8	Check valve	Brass, NBR (HNBR)	P424207	P424307	P424407	P424507
9	Piston guide assembly	POM, NBR	P424208A	P424308A	P424408A	P424508A
10	Needle assembly	Brass, NBR	P424209A	P424309A	P424409A	P424509A
11	Valve spring	Steel wire	P424211	P424311	P424411	P424511
12	Piston spring	Stainless steel	P424212	P424312	P424412	P424512
13	Check spring	Stainless steel	P424213	P424313	P424413	P424513
14	Needle spring	Steel wire	P424214	P424314	P424414	—
15	C type snap ring for shaft	Tool steel	G-5	STW-5	STW-8	STW-10
16	C type snap ring for hole	Tool steel	0-9	0-10	RTW-12	RTW-15
17	Seal	NBR	P424210	P424310	P424410	P424510
18	Seal	NBR	P424218	P424315	P424415	P424514
19	O-ring	NBR	10 x 8 x 1	11 x 9 x 1	12.5 x 9.5 x 1.5	16.5 x 12.5 x 2

Additional information

Catalogue	AV-B_EU.pdf
Declaration of conformity	newDoC_AV_TF122166EN.pdf DoC_AV_TFM0001.pdf newDoC_AV_TF1U018EN.pdf newDoC_AV_TF1V342EN.pdf
Installation manuals	IM_AV_TFQ49EN-A.pdf