

C(D)75, Air Cylinder, Double Acting, Single Rod, Standard CD75E40-200-B

Datasheet

General series information

- Standard Cylinder, Double Acting, Single Rod.
- Bore sizes (mm): 32, 40.
- Standard strokes up to 300mm.
- Auto switch capable.



Double-acting, single-rod cylinder

Standard specifications

Magnet	D (Built-in Magnet)
Series	75 (Standard)
Head Cover	E (Double End Boss-cut)
Bore Size	40mm
Stroke	200
Cushion	Rubber Bumper
Rod Boot	w/o Rod Boot
Mounting Bracket	None
Accessory	None
Auto Switch Mounting Type	B (Band Mounting)
Auto Switch	No Switch
Lead Wire or Prewired Connector	0.5m (Or None in the Case of No Switch)
Number	2 pcs. (Or None in the Case of No Switch)
Rod End Options	None
Temperature Resistance	None
Low Speed	None
Heavy Duty Scraper	None
Made of Stainless Steel	Standard
Long Stroke	Standard

Maximum operating pressure	1.0 MPa
Minimum operating pressure	0.05 MPa
Proof pressure	1.5 MPa
Pneumatic input connection	G 1/4
Pneumatic exhaust connection	G 1/4
Mode of operation of drive single	Double acting, Single rod
Maximum piston speed	50 mm/s
Type of cushioning	Air cushion
Male thread of rod end	M12 x 1.75
Minimum piston speed	10 mm/s
Lubrication	Not required (Non-lube)
Number of pneumatic connections	2
Fluid	Air
Ambient and fluid temperature	-10 - 60°C
Weight	1.195 Kg

Dimensions

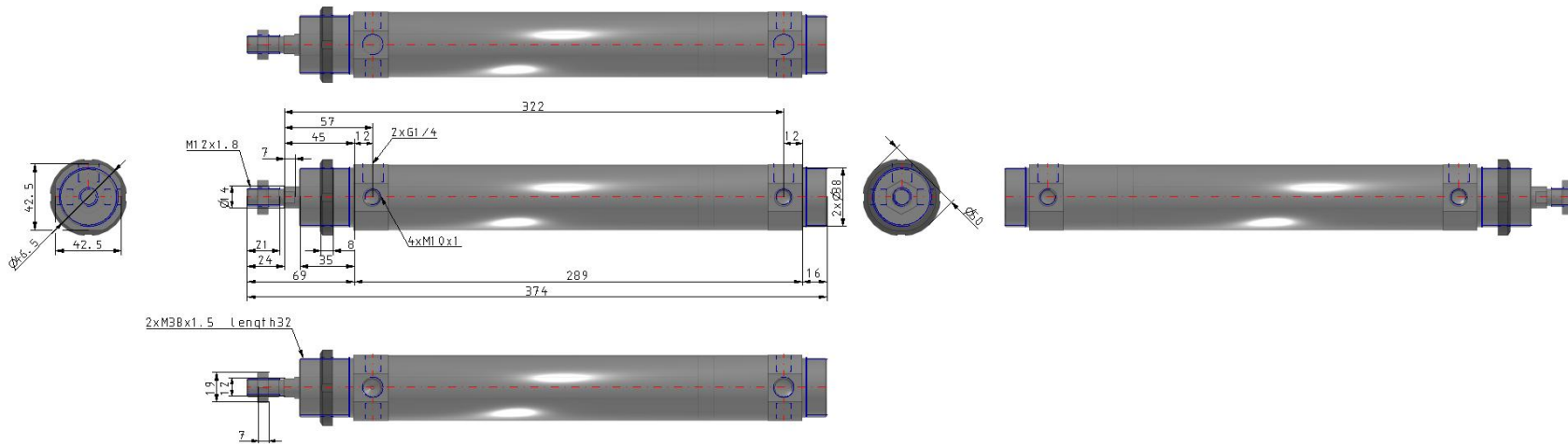

Additional information

Catalogue

[C85_C75-A_EU.pdf](#)