

Long Stroke - MHZL2 MHZL2-16S

Datasheet

General series information

- Maximum gripping force per finger 104 N at 0.5 MPa
- Double acting and single acting
- Repeatability: ± 0.01 mm
- Max. operating frequency: 120 c.p.m.



Gripper, normally open, single-acting with permanent magnet on piston

Standard specifications

Bore Size	16mm
Action	S (Single Acting (N.O.))
Finger Option	Basic Style
Body Option	Basic Style
Auto Switch	No Switch
Lead Wire or Prewired Connector	0.5m (Or None in the Case of No Switch)
Number	2 pcs (Or None in the Case of No Switch)
Maximum operating pressure	0.7 MPa
Minimum operating pressure	0.25 MPa
Maximum ambient temperature	60 °C
Minimum ambient temperature	-10 °C
Repeatability	± 0.01 mm
Weight	145 g
Lubrication	Non-lube
Effective holding force per finger, external (0.5 MPa)	27 N
Fluid	Air
Max. operating frequency	120 c.p.m.
Stroke per gripper jaw	12 mm
Weight	0.135 Kg

Dimensions

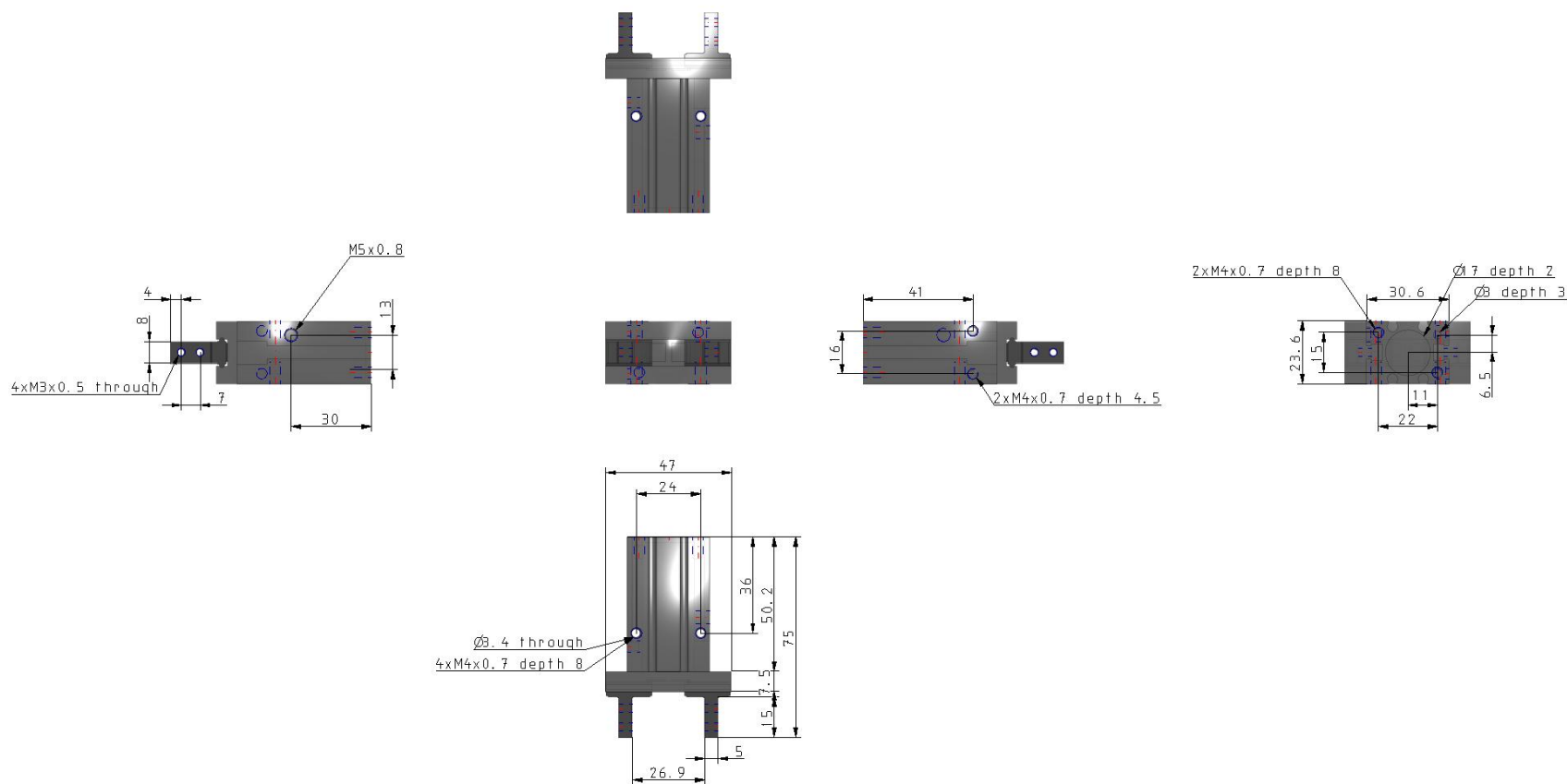

Constructions

Double acting/with fingers open

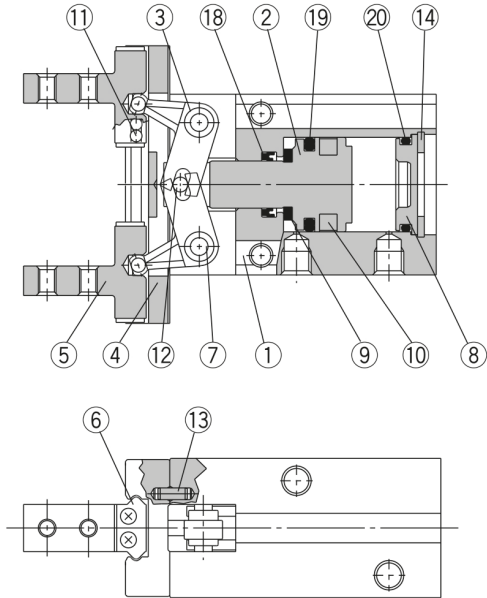

Single acting/normally open

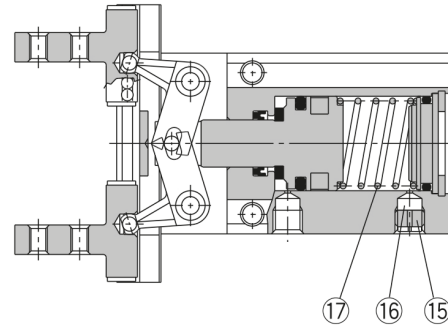

Single acting/normally closed

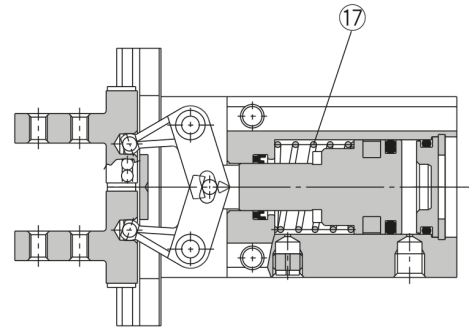

Double acting/with fingers closed

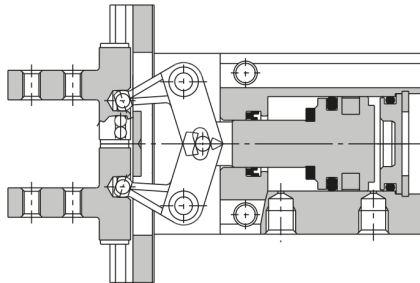

Parts list

No.	Description	Material	Note
1	Body	Aluminum alloy	Hard anodized
2	Piston	ø10, ø16: Stainless steel ø20, ø25: Aluminum alloy	ø20, ø25: Hard anodized
3	Lever	Stainless steel	Heat treated
4	Guide	Stainless steel	Heat treated
5	Finger	Stainless steel	Heat treated
6	Roller stopper	Stainless steel	
7	Lever shaft	Stainless steel	Nitrided
8	Cap	Aluminum alloy	Clear anodized
9	Bumper	Urethane rubber	
10	Rubber magnet	Synthetic rubber	

Parts list

No.	Description	Material	Note
11	Steel balls	High carbon chromium bearing steel	
12	Needle roller	High carbon chromium bearing steel	
13	Parallel pin	Stainless steel	
14	C type snap ring	Carbon steel	Nickel plated
15	Exhaust plug A	Brass	Electroless nickel plated
16	Exhaust filter A	Polyvinyl formal	
17	Spring	Stainless steel spring wire	
18	Rod seal	NBR	
19	Piston seal	NBR	
20	O-ring	NBR	

Additional information

Catalogue

[MHZ_EU.pdf](#)

Operation manuals

[OM_MHZ2_OMD0047EN-A.pdf](#)

[OM_MHZL2_OME0039EN.pdf](#)