

C(D)Q2, Compact Cylinder, Double Acting Single Rod, Long Stroke w/Auto Switch Mounting Groove

CDQ2A40TF-200DCZ

Datasheet

General series information

- Compact Cylinder: Long Stroke Double Acting, Single Rod
- Bore sizes (mm): 32, 40, 50, 63, 80, 100
- Standard stroke range (mm): 125 to 300
- Port threads: Rc, NPT or G
- Can mount small auto switches on 4 surfaces.



Double-acting, single-rod cylinder

Standard specifications

Magnet	D (Built-in)
Mounting	A (Both Ends Tapped)
Type	Standard
Bore Size	Ø40 mm
Port Thread Type	TF [G]
Stroke	200
Cushion	C (Rubber Bumper)
Body Option	Standard (Rod End Female Thread)
Auto Switch	No Switch
Lead Wire or Prewired Connector	0.5 m or None in the Case of No Switch
Number	2 pcs.
Rod End Options	None
Made of Stainless Steel	None
Fluororubber Seal	None
Pressure medium	Compressed air
Maximum temperature of pressure medium with magnet	60 °C
Minimum temperature of pressure medium with magnet	-10 °C
Maximum operating pressure	1.0 MPa

Minimum operating pressure	0.05 MPa
Proof pressure	1.5 MPa
Maximum ambient temperature with magnet	60 °C
Minimum ambient temperature with magnet	-10 °C
Number of pneumatic connections	2 pcs.
Pneumatic input connection	G 1/8
Mode of operation of drive	Double acting
Maximum piston speed	500 mm/s
Type of cushioning	Elastically
Piston rod end	Female-Thread
Geometric form of the piston rod	Single rod
Male thread of rod end	M14 x 1.5
Female thread of rod end	M8 x 1.25
Minimum piston speed	50 mm/s
Weight	1.081 Kg

Dimensions

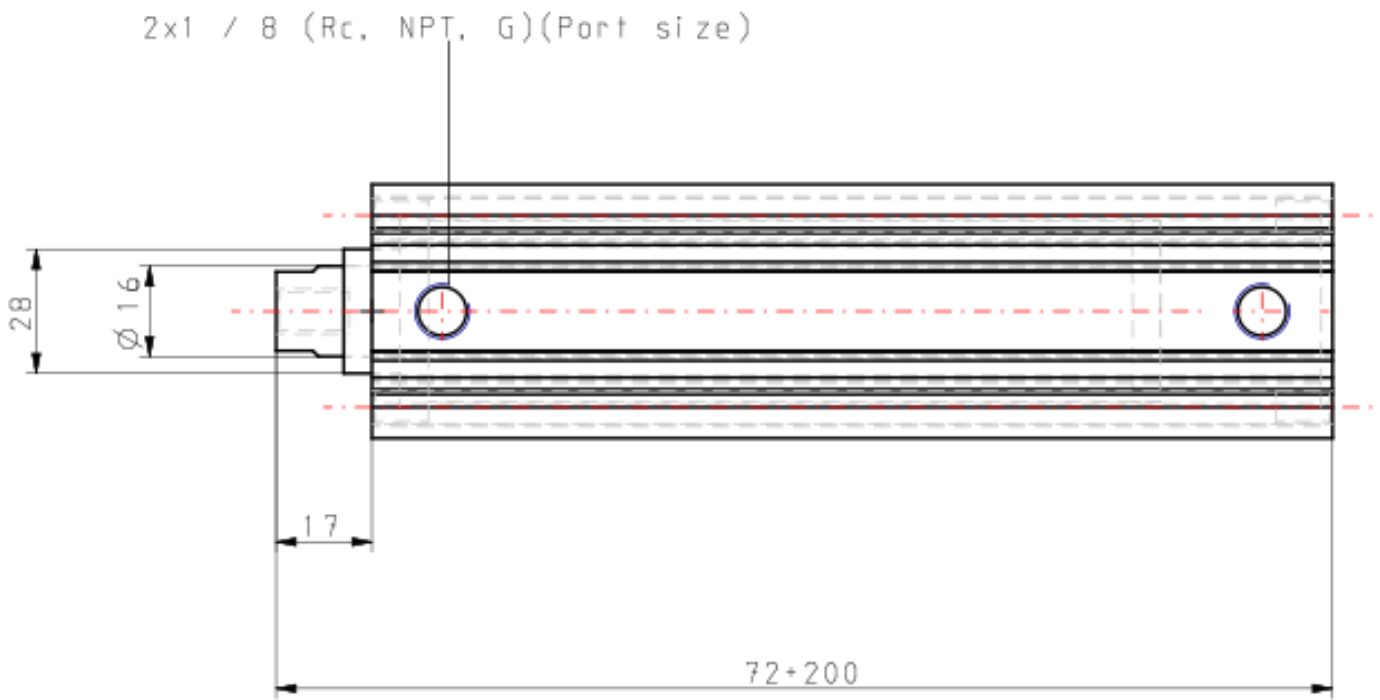

Constructions

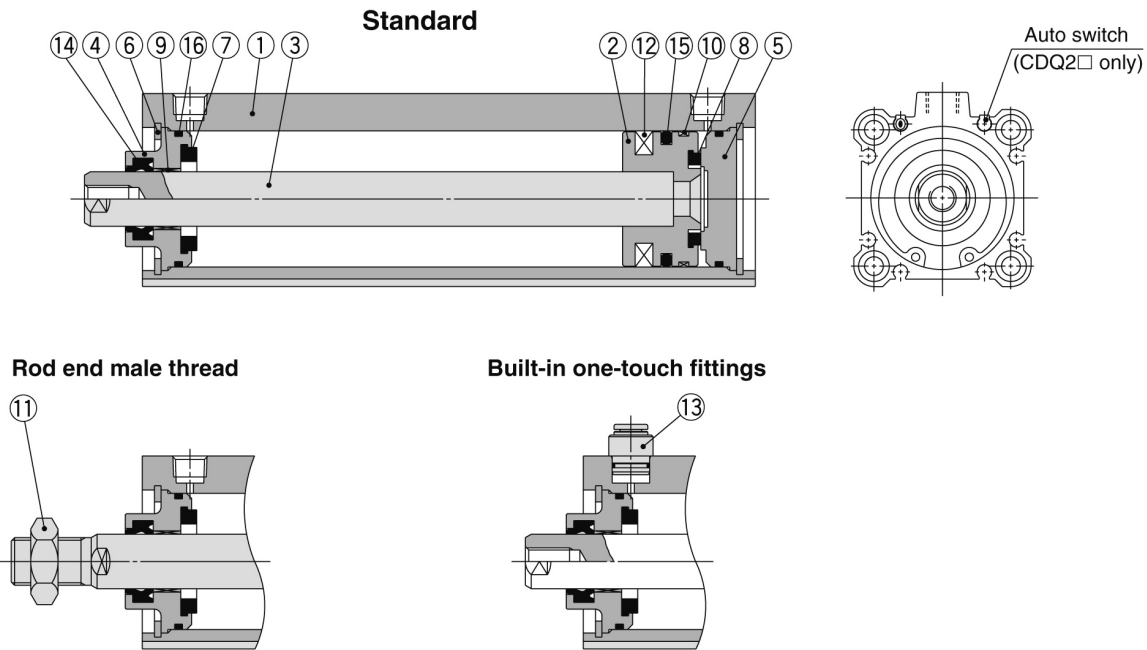

Component Parts

No.	Description	Material	Note
1	Cylinder tube	Aluminum alloy	Hard anodised
2	Piston	Aluminum alloy	Chromated
3	Piston rod	Carbon steel	Hard chrome plated
4	Collar	Aluminum alloy	Anodised
5	Bottom plate	Aluminum alloy	Anodised
6	Retaining ring	Carbon tool steel	Phosphate coated
7	Bumper A	Urethane	
8	Bumper B	Urethane	
9	Bushing	Bearing alloy	
10	Wear ring	Resin	
11	Rod end nut	Carbon steel	Nickel plated
12	Magnet	—	For CDQ2A□ only
13	One-touch fitting	—	ø32 to ø63
14*	Rod seal	NBR	
15*	Piston seal	NBR	
16*	Tube gasket	NBR	

Replacement Parts/Seal Kit

Bore size (mm)	Kit no.	Contents
32	CQ2A32-L-PS	Kits include items 14, 15, 16 from the table.
40	CQ2A40-L-PS	
50	CQ2A50-L-PS	
63	CQ2A63-L-PS	
80	CQ2A80-L-PS	
100	CQ2A100-L-PS	

* Seal kit includes 14, 15, 16. Order the seal kit, based on each bore size.

* Since the seal kit does not include a grease pack, order it separately.

Grease pack part no.: GR-S-010 (10 g)

Additional information

Catalogue

[CQ2-Z-C_EU.pdf](#)