

## Metric - KS KSH10-03S

### Datasheet

### General series information

- Rotary, One-touch fitting (standard)
- Metric threads
- Tube OD: Ø4, Ø6, Ø8, Ø10, Ø12
- Maximum operating pressure: 1.0 MPa
- Ambient & fluid temperature: -5 to 60°C

### Standard specifications

Model	H (Male Connector)
Applicable Tube OD	Ø10 mm
Port Size	03 (R[PT] 3/8)
Sealant	S [Sealant]
Pressure medium	Air
Maximum ambient temperature	60 °C
Minimum ambient temperature	-5 °C (no Freezing)
Usable tubing material	Nylon, Soft nylon, Polyurethane
Weight	0.063 Kg

## Dimensions

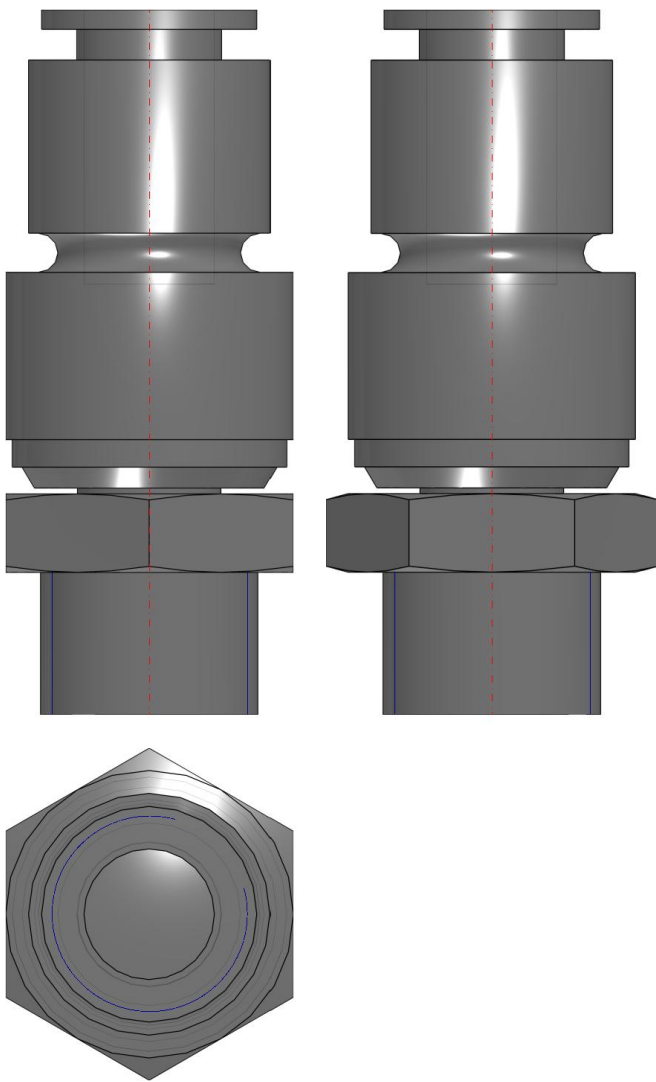

## Additional information

Catalogue

[KS\\_KX\\_EU.pdf](#)