

# IR1000/2000/3000, Precision Regulator IR1020-F01

Datasheet

## General series information

- Precision regulator
- Regulating pressure range (MPa): 0.005 to 0.8 depending on model
- Compact and lightweight
- Bracket & pressure gauge can be mounted on either the front or back
- 2 air operated models.

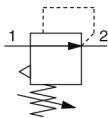

Pressure control valve, relieving pressure regulator, adjustable

## Standard specifications

Body Size	1 (IR1000)
Type of Setting	0 (Basic [Handle])
Set Pressure	2 (0.01~0.8MPa [IR1000/2000] or 0.01~0.8MPa [IR3000])
Thread	F [G(PF)]
Port Size	01 (1/8 [IR1000 Only])
Accessory	None
Suffix 1	Standard
Suffix 2	None
Made to Order	None
Switch Specifications	None
Pressure medium	Air
Maximum temperature of pressure medium	60 °C
Minimum temperature of pressure medium	-5 °C [with no freezing]
Maximum operating pressure	1.0 MPa
Minimum operating pressure	+0.05 Mpa
Maximum ambient temperature	60 °C
Maximum ambient temperature with magnet	-5 °C [with no freezing]
Approvals	No need

Sensitivity	Within 0.2% of full span
Repeatability	Within 0.5% of full span
Set pressure range	0.01 - 0.8 MPa
Linearity	Within 1% of full span
Air consumption (At supply pressure of 1.0 MPa)	4.4 l/min (ANR) or less
Input signal pressure	0.01 - 0.8 Mpa
Weight	0.140 Kg

Specifications are subject to change without prior notice and any obligation on the part of the manufacturer.

# Dimensions

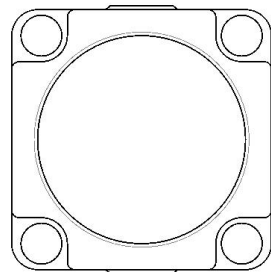
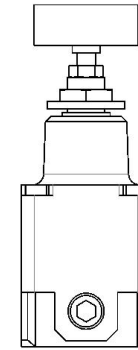
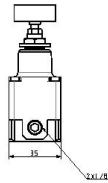
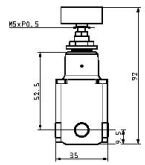
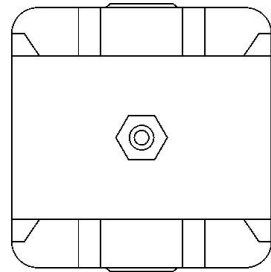

# Constructions

## Construction

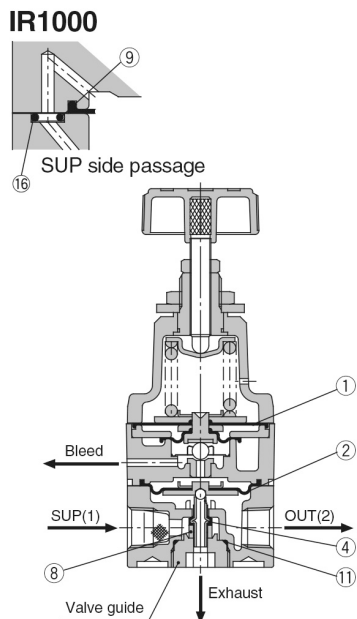

### Replacement Parts

No.	Description	Material	IR10□0	
			Part no.	Qty.
1	Diaphragm assembly	NBR, other	P362010-1	1
2	Diaphragm assembly	NBR, other	P362010-2	1
3	Diaphragm	NBR, other	—	—
4	Valve	Stainless steel, NBR	P36201058	1
5	Valve	Stainless steel, NBR	—	—
6	Valve	Brass, NBR	—	—
7	Valve	Brass, NBR	—	—
8	Damper	NBR, other	P36201021	1
9	O-ring	H-NBR	ø2.5 x 1.05	3
10	O-ring	NBR	—	—
11	O-ring	NBR	ø10 x 1.3	1
12	O-ring	NBR	—	—
13	O-ring	NBR	—	—
14	Seal (A)	NBR	—	—
15	Seal (B)	NBR	—	—
16	Fixed throttle	Stainless steel	P36202018	1
Repair kit no. (A set of above nos. ① to ⑮.)			KT-IR1000	

## Additional information

Catalogue	<a href="#">IR1000-2000-3000-B_EU.pdf</a>
Operation manuals	<a href="#">OM_IR30-OM00002EN-F.pdf</a> <a href="#">IR10-OM00006_GB.pdf</a> <a href="#">OM_IR20-OM00004EN-E.pdf</a> <a href="#">OM_IR10_OM00002EN-E.pdf</a> <a href="#">OM_IR20_OM00002EN-F.pdf</a> <a href="#">OM_IR30_OM00004EN-F.pdf</a>