

ARP20/30/40, Direct Operated Precision Regulator ARP40-F03E

Datasheet

General series information

- Air consumption decrease by 80% from the existing product (ARP3000).
- Allows precise control of air pressure.
- Standard backflow function (ARP20K/30K/40K).
- Standard digital pressure switches.
- Compatible with the new AC spacers.

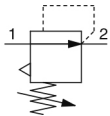

Pressure regulator

Standard specifications

Size	40
Backflow Function	None
Thread	F (G)
Port Size	03 (3/8)
Accessory	E (Square Embedded Pressure Gauge w/Limit Indicator)
Specifications	0.005 to 0.4 MPa Setting
Pressure Unit	Name plate & Pressure Gauge in SI Units: MPa
Pressure medium	Air
Maximum temperature of pressure medium	60 °C
Minimum temperature of pressure medium	-5 °C (with no freezing)
Maximum operating pressure	0.7 MPa
Proof pressure	1.2 MPa
Maximum ambient temperature	60 °C
Minimum ambient temperature	-5 °C (with no freezing)
Approvals	No need
Sensitivity	Within 0.2% F.S.
Repeatability	Within ±1% F.S. (or ±3 kPa)
Set pressure range	0.005 - 0.4 MPa

Weight

0.340 Kg

Dimensions

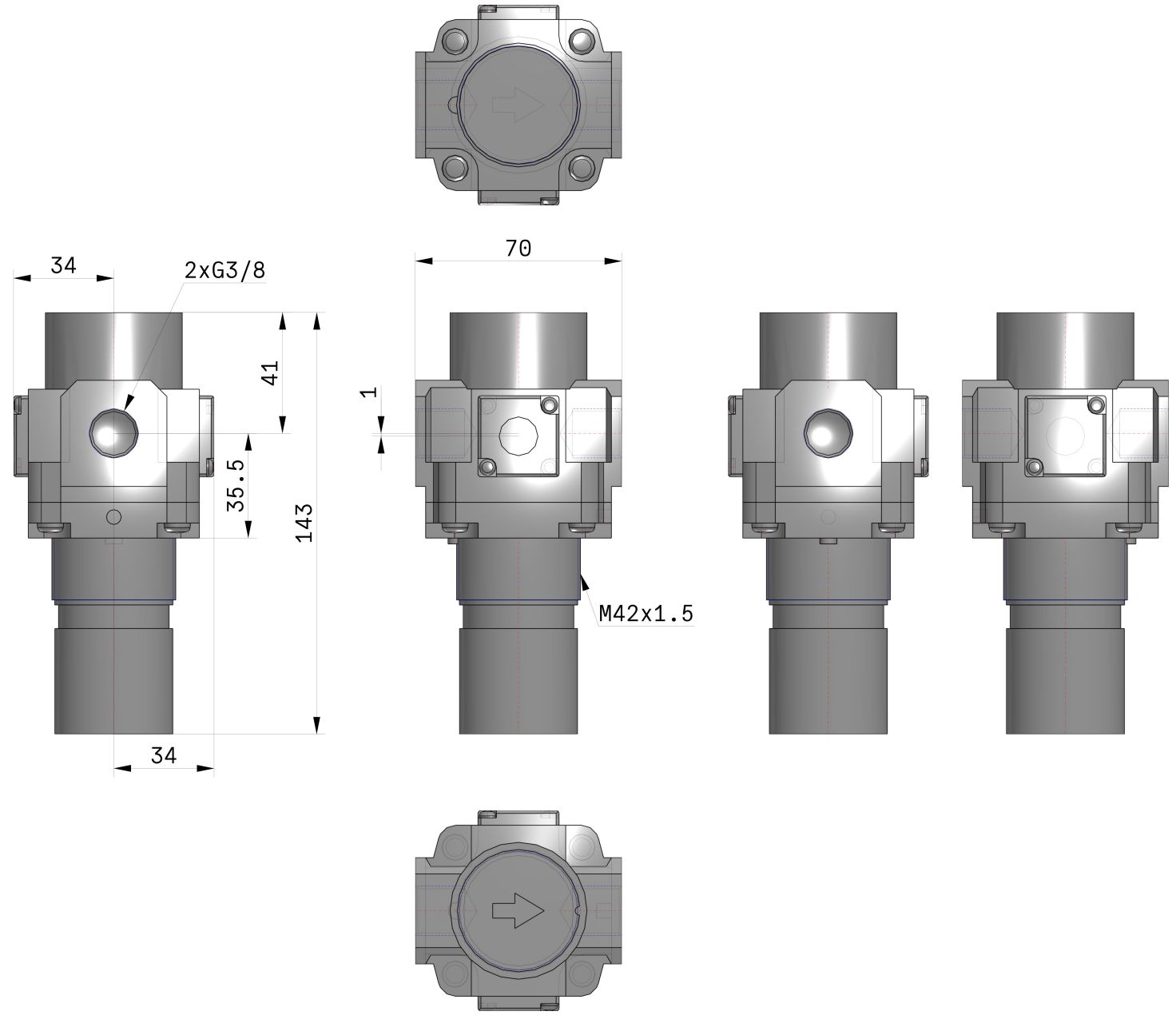

Specifications are subject to change without prior notice and any obligation on the part of the manufacturer.

Additional information

Catalogue	ARP20-30-40_EU.pdf
Installation manuals	IM_ARP_SMU48EN.pdf
Operation manuals	OM_ARPxK_OML0043EN-B.pdf OM_ARP_OML0044EN-A.pdf