

MY1B-Z, Mechanical Joint Rodless Cylinder, Basic Type w/o Stroke Adjustment

MY1B32TFG-500Z

Datasheet

General series information

- w/o Stroke Adjustment Unit
- Easy adjustment of the cushion needle.
- Entrance of external particle is reduced, reliability improved and maintenance costs reduced.
- Piping flexibility because it can be connected in 4 directions and it can be selected from 2 types (standard and centralised).
- Flexibility in the auto switch mounting.

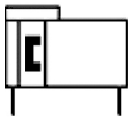

Mechanically Jointed Rodless Cylinder

Standard specifications

Bore Size	32mm
Port Thread	TF (G)
Piping	G (Centralized Piping Type)
Stroke	500
Stroke Adjustment Unit	Left: w/o Unit; Right: w/o Unit
Auto Switch	No Switch
Lead Wire or Prewired Connector	0.5m (Or None in the Case of No Switch)
Number	2 pcs. (Or None in the Case of No Switch)
Pressure medium	Compressed air
Maximum temperature of pressure medium	60 °C
Maximum temperature of pressure medium with magnet	60 °C
Minimum temperature of pressure medium	5 °C
Minimum temperature of pressure medium with magnet	5 °C
Maximum operating pressure	0.8 MPa
Minimum operating pressure	0.1 MPa
Proof pressure	1.2 MPa
Maximum ambient temperature	60 °C

Maximum ambient temperature with magnet	60 °C
Minimum ambient temperature	5 °C
Minimum ambient temperature with magnet	5 °C
Pneumatic input connection	G 1/8
Mode of operation of drive single	Double Acting
Theoretical cylinder force, advance stroke (at 0.5 MPa)	402 N
Maximum piston speed	1000 mm/s
Type of cushioning	Air Cushion
Number of pneumatic connections	2 pcs.
Usable tubing material	PU
Weight	3.750 Kg

Dimensions

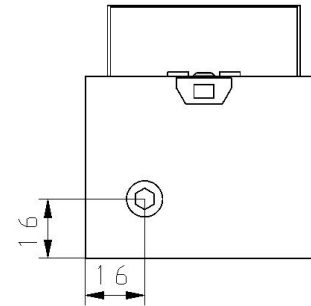
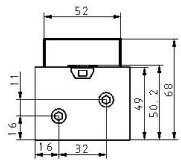

Constructions

MY1B25 to 40

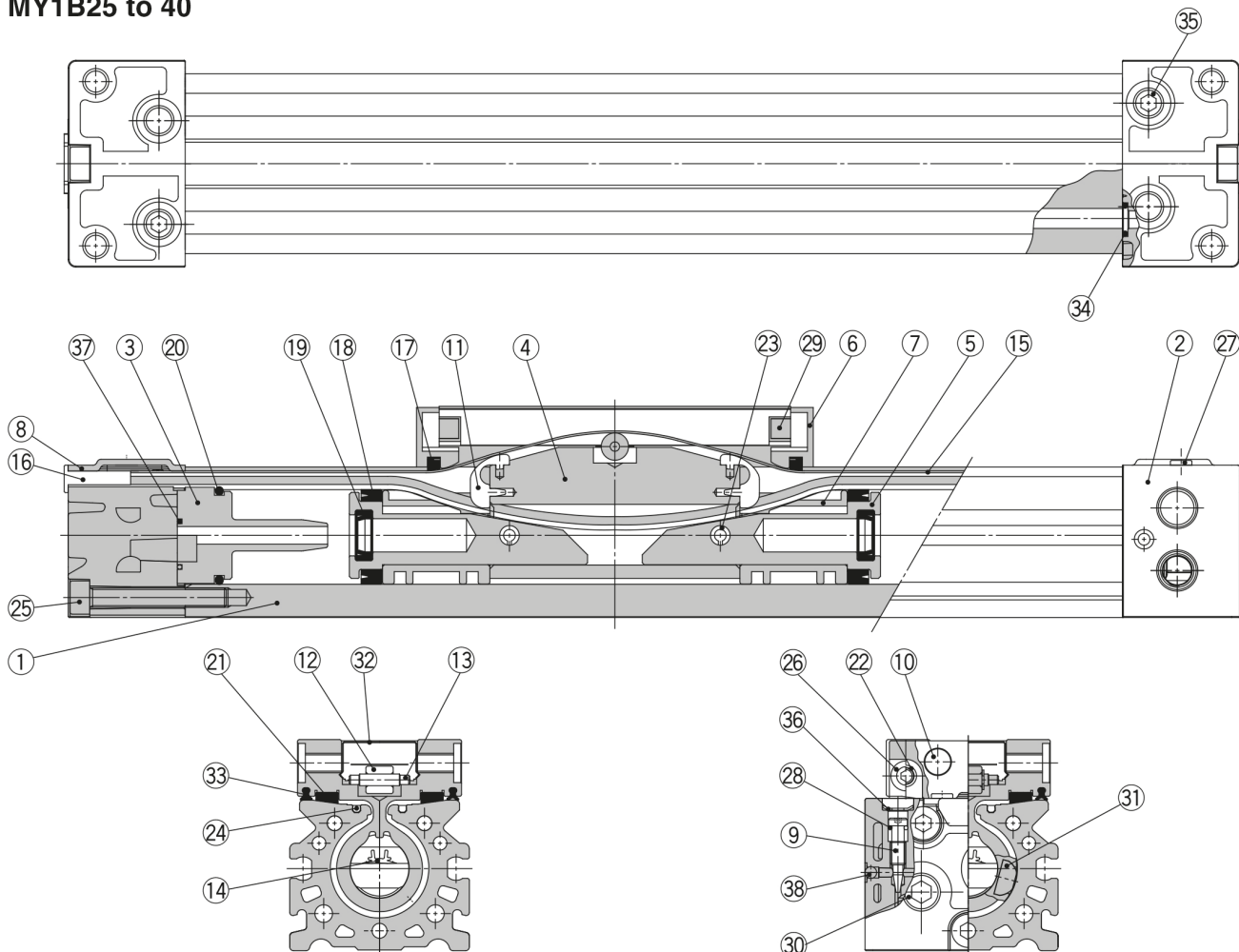

Component Parts

No.	Description	Material	Qty.	Note
1	Cylinder tube	Aluminium alloy	1	Hard anodised
2	Head cover	Aluminium alloy	2	Painted
3	Cushion boss	Polyacetal	2	
4	Piston yoke	Aluminium alloy	1	Anodised
5	Piston	Aluminium alloy	2	Chromated
6	End cover	Polyacetal	2	
7	Wear ring	Polyacetal	2	
8	Head plate	Stainless steel	2	
9	Cushion needle	Rolled steel	2	Nickel plated
10	Stopper	Carbon steel	4	Nickel plated
11	Belt separator	Polyacetal	2	
12	Guide roller	Polyacetal	1	
13	Parallel pin	Carbon steel	1	
16	Belt clamp	Polybutylene terephthalate	2	
21	Bearing	Polyacetal	2	

No.	Description	Material	Qty.	Note
22	Spacer	Stainless steel	4	
23	Spring pin	Carbon tool steel	2	
24	Seal magnet	Rubber magnet	2	
25	Hexagon socket head cap screw	Chromium molybdenum steel	6	Chromated
26	Hexagon socket button head screw	Chromium molybdenum steel	4	Chromated
27	Thin head screw	Chromium molybdenum steel	4	Chromated
29	Double round parallel key	Carbon steel	2	
30	Hexagon socket head taper plug	Carbon steel	4	Chromated (Centralised piping: 7 pcs.)
31	Magnet	Rare earth magnet	2	
32	Top cover	Stainless steel	1	
35	Hexagon socket head taper plug	Carbon steel	2	Chromated (Centralised piping: 3 pcs.)
36	Type CR retaining ring	Spring steel	2	
38	Steel ball	Spring steel	2	

Additional information

Catalogue

[MY1B-Aa_EU.pdf](#)

Operation manuals

[OM_MY1_MYZZ-OM0009QEN.pdf](#)