

ARM5S, Regulator Single Unit Type ARM5SA-06

Datasheet

General series information

- Small compact manifold regulator, single unit.
- Two mounting style available: Direct mount, DIN rail mount.
- Metric and Inch size IN/OUT Fitting Type.
- Options include with or without pressure gauge, 0.35MPa setting, non-relieving, and unit representation.

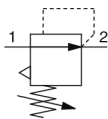

Pressure control valve, relieving pressure regulator, adjustable

Standard specifications

Regulator Mounting	A (Direct Mount)
IN/OUT Fitting Type	06 [IN/ø4 (Straight) - OUT/ø4 (Straight)]
Accessory	w/o Pressure Gauge
Options	None
Unit Representation	Display Unit for Product Name Plate and Pressure Gauge: MPa
Maximum operating pressure	1.0 MPa
Proof pressure	1.5 MPa
Set pressure range	0.05 - 0.7 MPa
Fluid	Air
Regulator construction	Direct acting
Working principle	Piston type
Relief mechanism	Relief type
Backflow function	Built-in (unbalance type)
Ambient and fluid temperature	5 - 60 °C
Weight	0.023 Kg

Dimensions

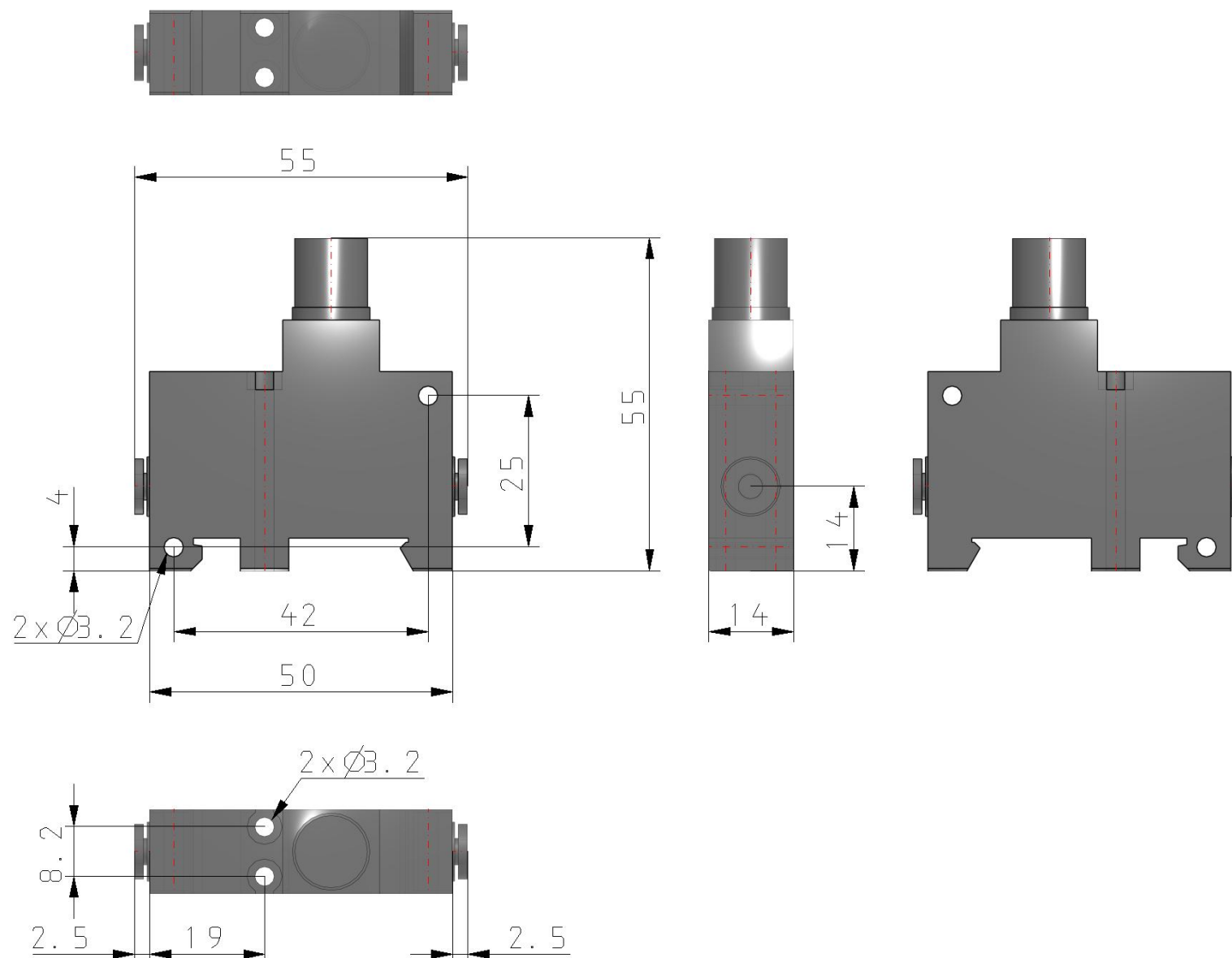

Constructions

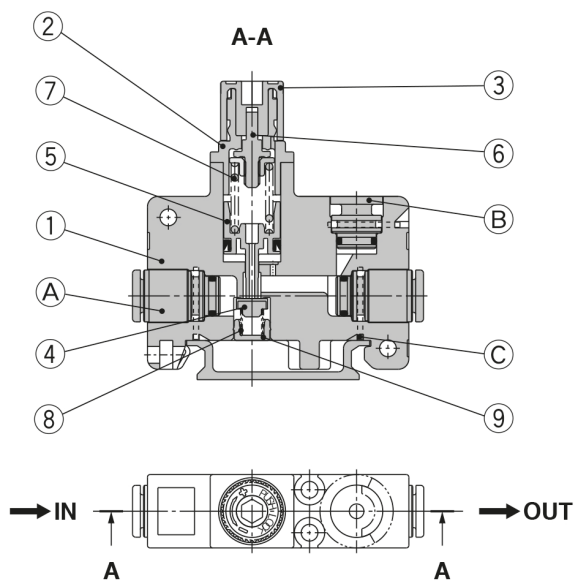

Component Parts

No.	Description	Material
1	Body (for single unit)	PBT
2	Bonnet	PBT
3	Handle	POM
4	Valve	HNBR, Aluminum alloy
5	Piston assembly	POM, NBR
6	Adjusting screw assembly	—
7	Adjusting spring	Stainless steel
8	Valve spring	Stainless steel
9	Valve guide	Brass
10	Clip	Stainless steel

No.	Description	Material
A	Fitting assembly	—
B	Port plug	PBT, HNBR
C	Clip	Stainless steel

Additional information

Catalogue

[ARM5_EU.pdf](#)

Operation manuals

[arm5_op_manual_ar_-omj0032.pdf](#)