

Standard – ASP ASP430F-F02-06S

Datasheet

General series information

- Port Size: 1/8, 1/4, 3/8, 1/2
- Applicable Tubing O.D.: Ø 6 to Ø 12 mm and Ø 1/4" to Ø 1/2"
- Operating Pressure Range: 0.1 to 1 MPa.

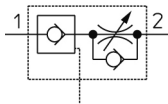

Speed controller with pilot check valve

Standard specifications

Body Size	4 (1/4 Basis)
Port Size	F02 (Cylinder Side [R[PT] 1/4] Pilot Port [G[PF] 1/8])
Applicable Tube OD	Ø6
Made to Order	None
Lock Nut	Standard (Hexagon)
Pressure medium	Compressed Air
Maximum temperature of pressure medium	60 °C
Minimum temperature of pressure medium	-5 °C
Maximum operating pressure	1 MPa
Minimum operating pressure	0.1 MPa
Proof pressure	1.5 MPa
Maximum ambient temperature	60 °C
Minimum ambient temperature	-5 °C
Function of Flow control valve	Meter-out
Flow rate	330 l/min
Pilot check valve actuation pressure	50 % or more of operating pressure
Number of needle revolutions	10
Weight	0.070 Kg

Dimensions

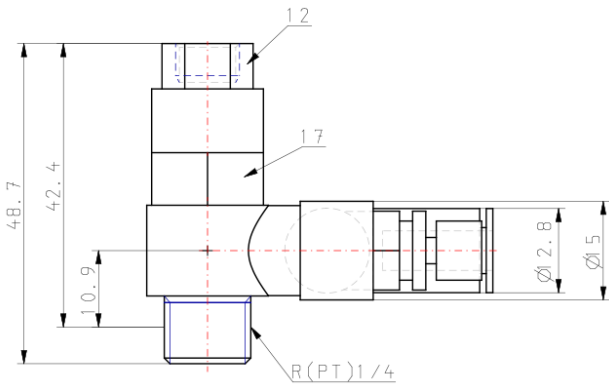
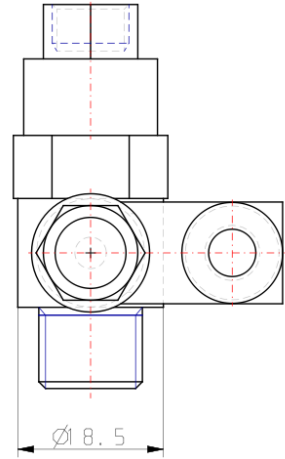
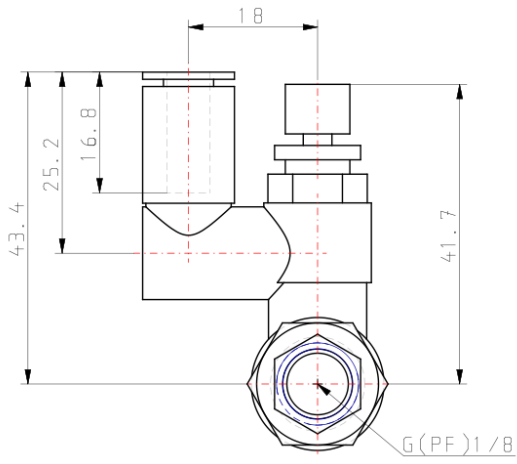

Constructions

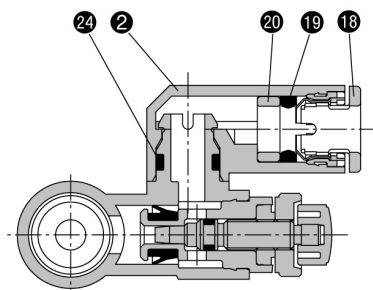
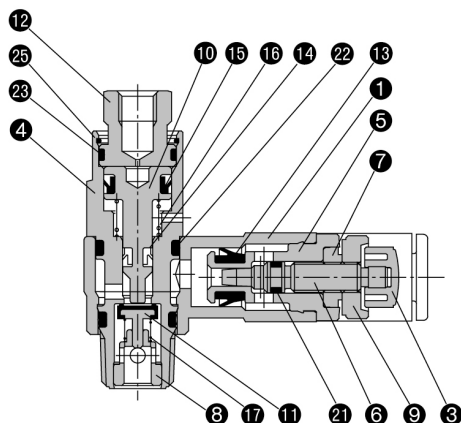

Parts list

No.	Description	Material	Note
1	Body A	PBT	
2	Elbow body	PBT	
3	Knob	PBT	
4	Pilot body	Brass	Electroless nickel plated
5	Body B	Brass	Electroless nickel plated
6	Needle	Brass	Electroless nickel plated
7	Needle guide	Brass	Electroless nickel plated
8	Guide	Brass	Electroless nickel plated
9	Lock nut	Brass	Electroless nickel plated
10	Piston	Brass	Electroless nickel plated
11	Valve	Stainless steel, NBR	
12	Cover	Brass	Black zinc chromated
13	U seal	NBR	

Parts list

No.	Description	Material	Note
14	DY seal	PBT	
15	DY seal	PBT	
16	Spring	Stainless steel	
17	Spring	Stainless steel	
18	Cassette	POM, Stainless steel ^{Note 1)}	
19	Seal	NBR	
20	Spacer	POM ^{Note 2)}	
21	O-ring	NBR	
22	O-ring	NBR	
23	O-ring	NBR	
24	O-ring	NBR	
25	Ring	Stainless steel	

Note 1) $\phi 10$, $\phi 12$, $\phi 3/8"$, $\phi 1/2"$ are POM, stainless steel and brass (electroless nickel plated).
 Note 2) $\phi 1/4"$, $\phi 3/8"$, $\phi 1/2"$ are brass (electroless nickel plated).

Additional information

Catalogue

[ASP-A_EU.pdf](#)

Installation manuals

[IM_ASP_TF222-097EN-A.pdf](#)