

CP96S(D) ø125, ISO Cylinder, Double Acting with End of Stroke Cushioning CP96SDB125-160

Datasheet

General series information

- Double acting, standard type, single or double rod
- Bore sizes (mm): 125
- Maximum stroke 2000mm
- Auto switch capable

Standard specifications

Magnet	D (Built-in)
Mounting	B (Basic, w/o Bracket)
Bore Size	Ø125
Stroke	160
Rod Boot	None
Rod	Single Rod
Auto Switch	No Switch
Lead Wire or Prewired Connector	0.5m [Or None in the Case of No Switch]
Number	2 pcs. [Or None in the Case of No Switch]
Rod End Options	None
Temperature Resistance	None
Tie Rod	None
Fluororubber Seal	None
Made of Stainless Steel (-XC68)	None
Pressure medium	Compressed Air
Maximum temperature of pressure medium	70 °C
Maximum temperature of pressure medium with magnet	60 °C
Minimum temperature of pressure medium	-20 °C [without condensation]
Minimum temperature of pressure medium with magnet	-10 °C [without condensation]

Maximum operating pressure	1.0 MPa
Minimum operating pressure	0.05 MPa
Proof pressure	1.5 MPa
Maximum ambient temperature	70 °C
Maximum ambient temperature with magnet	60 °C
Minimum ambient temperature	-20 °C
Minimum ambient temperature with magnet	-10 °C
Approvals	CE
Number of pneumatic connections	2 pcs.
Pneumatic input connection	G 1/2
Pneumatic output connection	G 1/2
Mode of operation of drive	Double acting
Maximum piston speed	700 mm/s
Type of cushioning	Both Ends (Air Cushion)
Piston rod end	Male thread
Male thread of rod end	M27 x 2
Weight	9.600 Kg

Dimensions

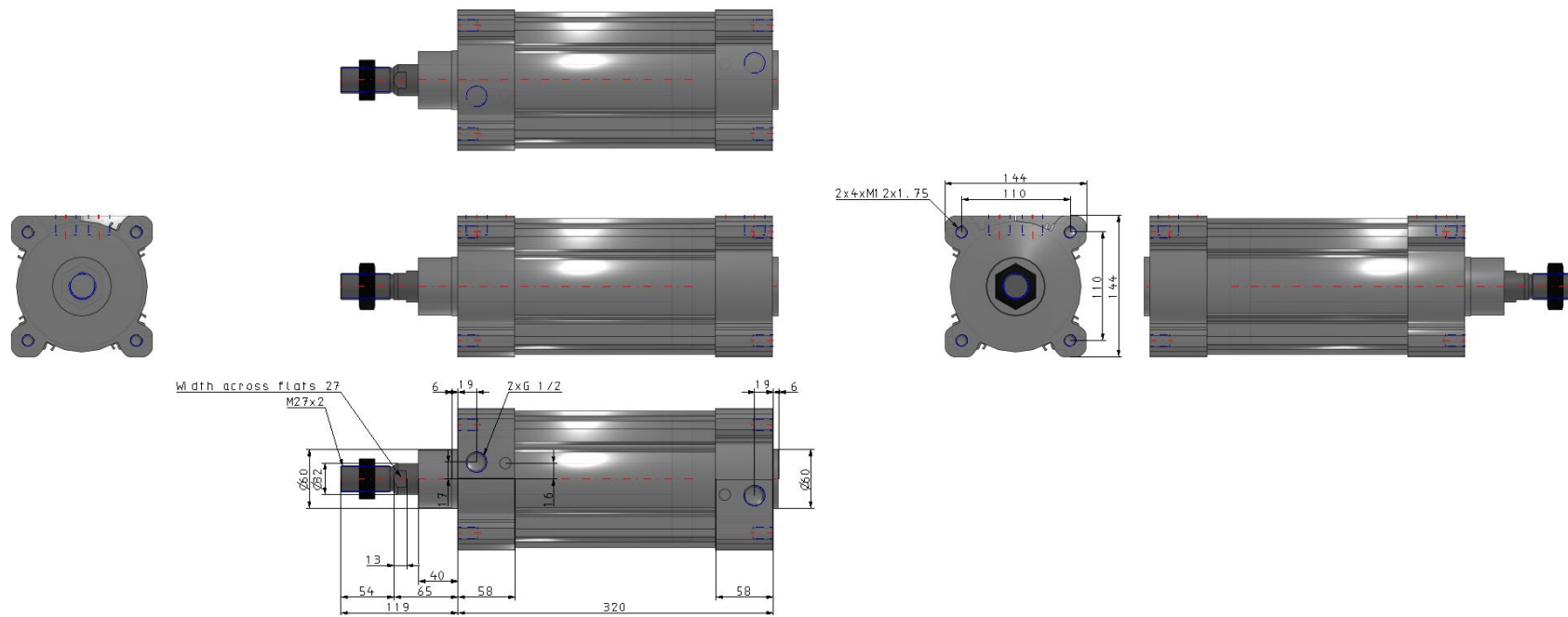

Additional information

Catalogue

[CP96-Bb_EU.pdf](#)