

Elbow - AS*2*1F-A AS2211F-02-04SA

Datasheet

General series information

- Port Size: M5, 10-32 UNF, 1/8, 1/4, 3/8, 1/2
- Applicable Tubing O.D.: Ø 2 to Ø 16 mm and Ø 1/8" to Ø 1/2"
- Operating Pressure Range: 0.1 to 1 MPa.



Flow control valve, adjustable, with reverse free flow

Standard specifications

Clean Series	None
Body Size	2 (1/8, 1/4)
Type	2 (Elbow)
Control Type	1 (Meter-in)
Thread Type	R or Metric
Port Size	02 (1/4)
Across Flat [H]	Body Size 1: 9mm; Body Size 2, 3, 4 None
Applicable Tubing O.D.	Ø4
Seal	S (w/Sealant)
Made to Order	None
Pressure medium	Compressed air
Maximum temperature of pressure medium	60 °C
Minimum temperature of pressure medium	-5 °C
Maximum operating pressure	1 MPa
Minimum operating pressure	0.1 MPa
Proof pressure	1.5 MPa
Maximum ambient temperature	60 °C
Minimum ambient temperature	-5 °C
Critical pressure ratio	0.2
Sonic conductance dm ³ /(s·bar)	0.9

Number of needle rotations	10
Weight	0.018 Kg

Dimensions

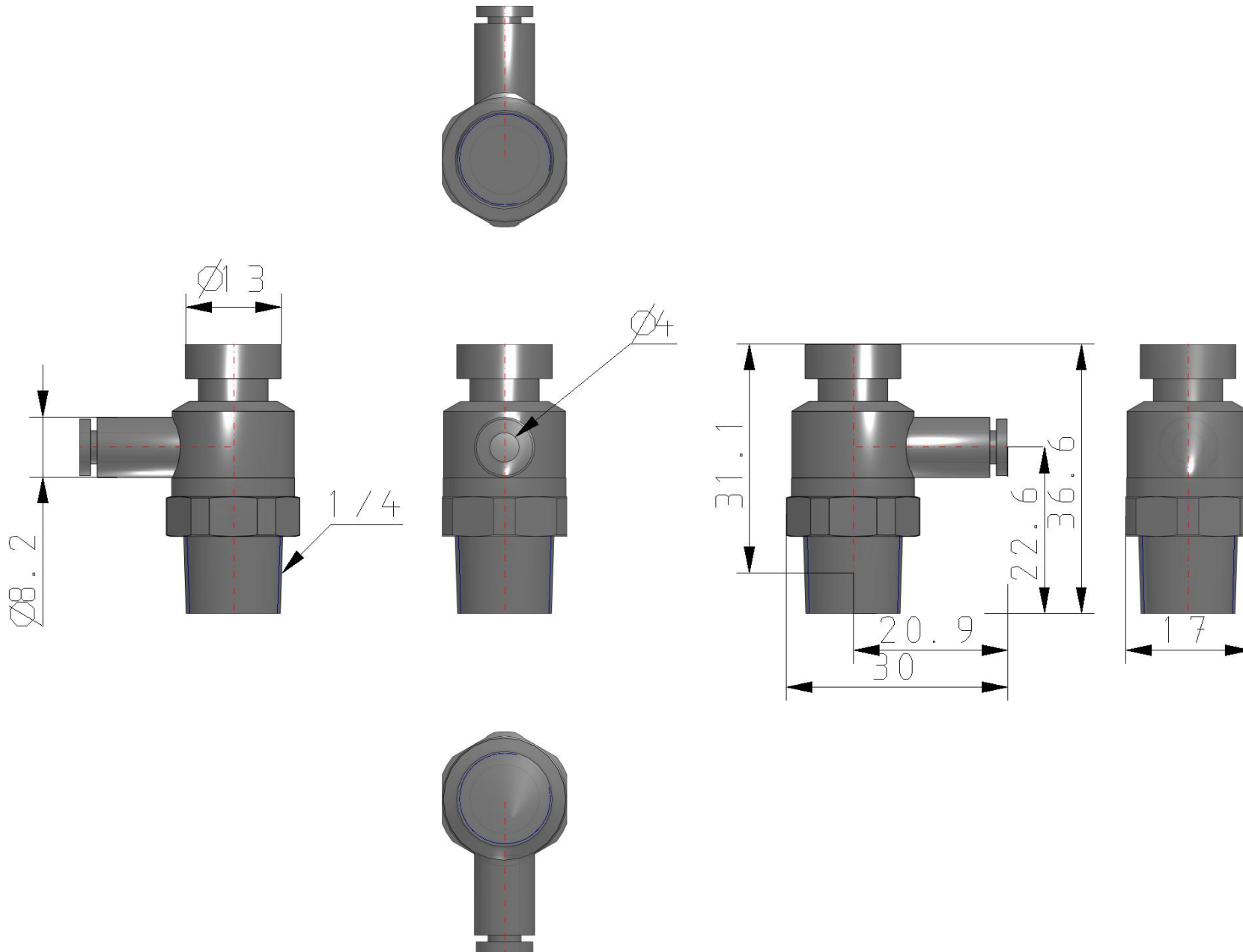

Constructions

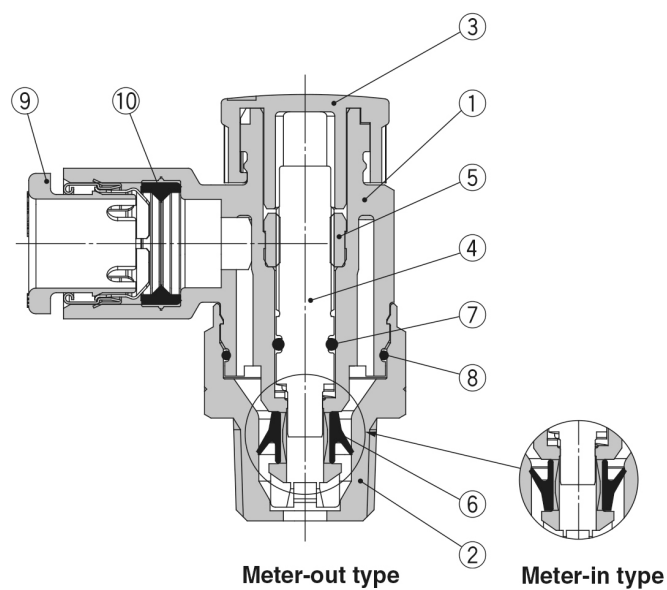

Component Parts

No.	Description	Material	Note
1	Body A	PBT	
2	Body B	Brass	Electroless nickel plating
3	Knob	POM	
4	Needle	PBT	
5	Needle guide	Brass	Electroless nickel plating
6	U-seal	HNBR	
7	O-ring	NBR	
8	O-ring	NBR	
9	Cassette	—	
10	Seal	NBR	

Additional information

Catalogue

[AS-1F_FG-A-Dd_EU.pdf](#)