

VM200, 200 Series 2/3 Port Mechanical Valve

VM230-02-40A

Datasheet

General series information

- Fluid: Air/Inert gas.
- Large flow capacity.
- Possible to choose mounting method with side ported.
- Variety of actuator types.

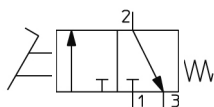

Directional control valve 3/2-way valve, closed normal position With manual control pedal Return with mechanical control spring

Standard specifications

Number of Ports	3 Port
Body Option	Side Mounting
Port Size	02 (R 1/4)
Actuator Type	40 (Foot Pedal)
Suffix	None
Bracket	None
Pressure medium	Air/Inert gas
Maximum temperature of pressure medium	60 °C
Minimum temperature of pressure medium	-5 °C (No freezing)
Maximum operating pressure	1.0 MPa
Minimum operating pressure	0 MPa
Maximum ambient temperature	60 °C
Minimum ambient temperature	-5 °C (No freezing)
Pneumatic input connection	R 1/4
Pneumatic exhaust connection	R 1/4
Function in normal position	Exhausted
Type of piloting	Directly
Valve return	Mechanical spring
Flow rate	1088 l/min

Critical pressure ratio	0.4
Sonic conductance dm ³ /(s·bar)	4
Actuation type	Manually
Weight	0.430 Kg

Specifications are subject to change without prior notice and any obligation on the part of the manufacturer.

Dimensions

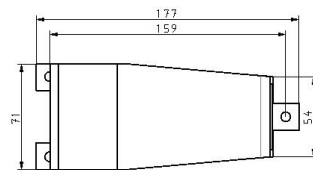
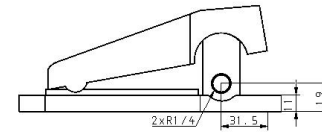
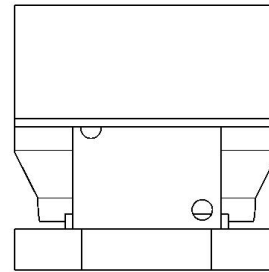
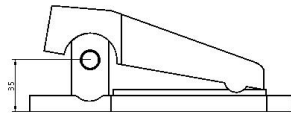
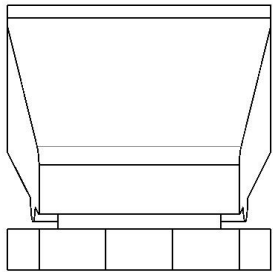
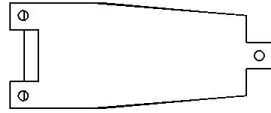

Constructions

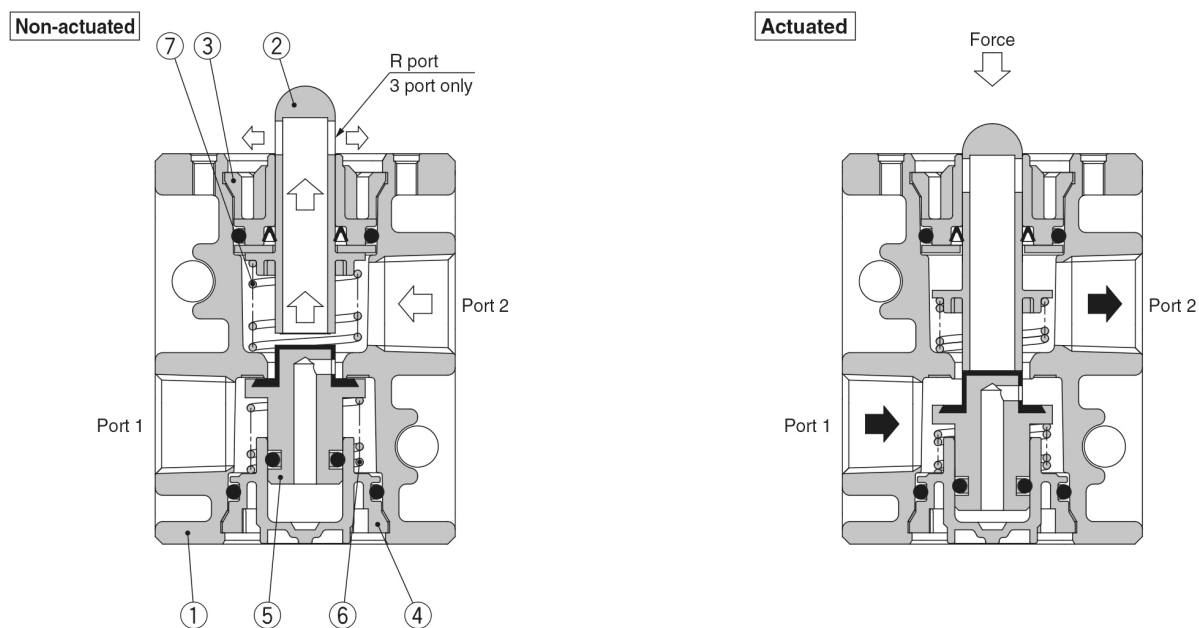

Component Parts

No.	Description	Material	Note
1	Valve	ADC	White coated
2	Plunger	Polyacetal	2 port Grey
			3 port White
3	Plunger retainer	PBT	
4	Cover	PBT	
5	Inner valve	NBR, Brass	
6	Spring	Stainless steel	
7	Spring	Spring steel	

Additional information

Catalogue	VM100-200-A_EU.pdf
Installation manuals	IM_VM100_TF2Z478EN-C.pdf