

VHK-A, Finger Valve, One-touch Fitting

VHK2A-10F-10FL

Datasheet

General series information

- 1(P)/2(A) One-touch fitting.



Directional control valve 2/2-way valve, closed normal position return with control mechanism by turning return with mechanical control spring

Standard specifications

Valve	2 (2-Port Valve)
1(P) Applicable Tubing O.D.	ø 10
2(A) Applicable Tubing O.D.	ø 10
Knob Colour	Grey (2-port); Blue (3-port)
Bracket	L (With L-bracket)
Pressure medium	Air
Maximum temperature of pressure medium	60 C
Minimum temperature of pressure medium	0 C
Maximum operating pressure	1.0 MPa
Minimum operating pressure	-100 kPa
Proof pressure	1.5 MPa
Maximum ambient temperature	60 C
Minimum ambient temperature	0 C
Usable tubing material	Nylon,Soft nylon,Polyurethane
Weight	0.029 Kg

Dimensions

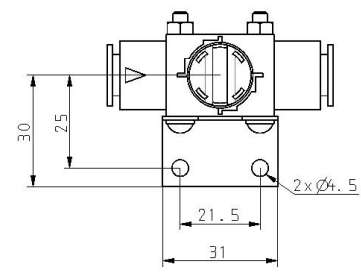
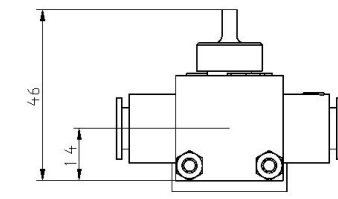
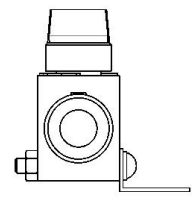
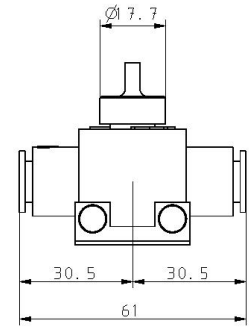
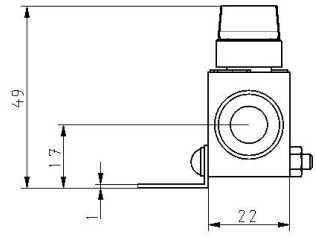
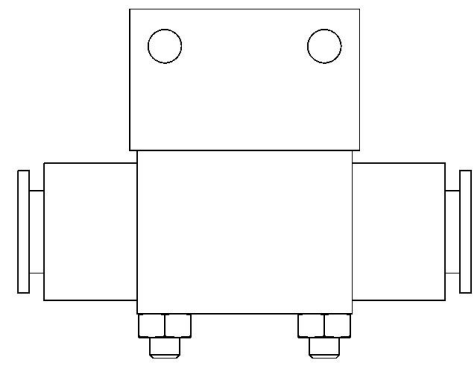

Constructions

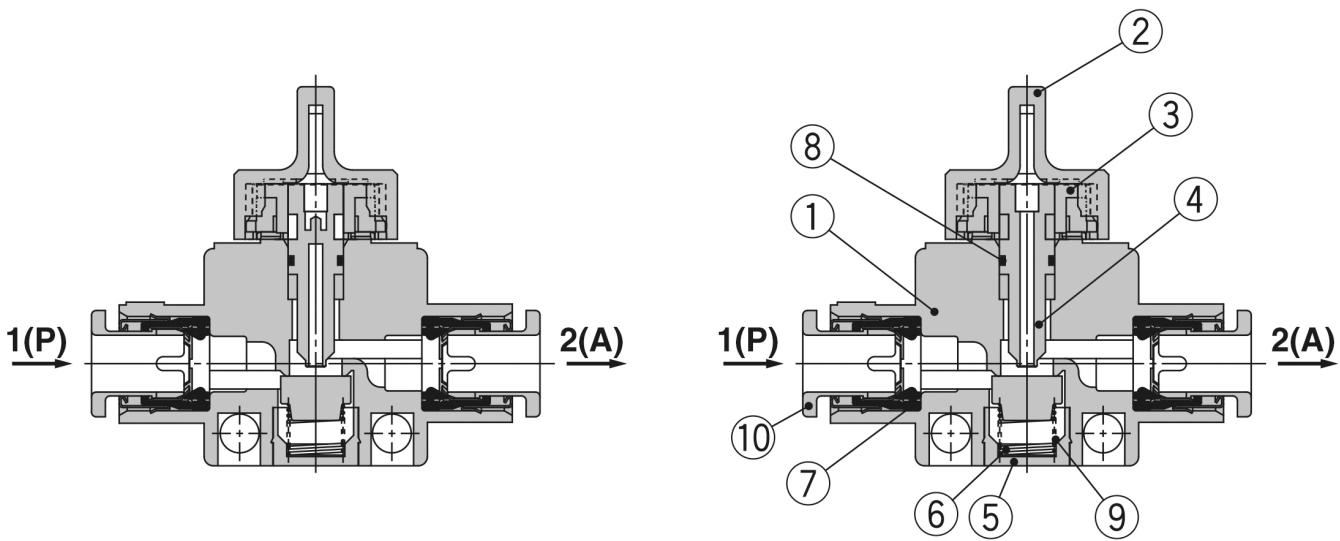

No.	Description	Material	Note
1	Body	PBT	
2	Knob	POM	
3	Cam ring	POM	
4	Stem	POM	
5	Spring guide	Brass	Electroless nickel plated
6	Spring	Stainless steel	
7	Seal	NBR	
8	O-ring	NBR	
9	Valve	NBR	
10	Cassette	—	

Additional information

Catalogue

[VHK-Aa_EU.pdf](#)