

IDG-A, Membrane Air Dryer IDG30A-F03

Datasheet

General series information

- Membrane air dryer series
- Energy saving
- Single unit style
- 5 sizes available
- Port sizes: 1/4" to 1/2"

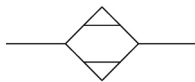

Dryer

Standard specifications

Size	30 [300 l/min (: -20°C/-15°C) - 75 l/min (: -40°C)]
Standard Dew Point	-20°C
Thread	F (G(PF))
Port Size	03 (3/8)
Accessory	None (Standard)
Option	Standard
Pressure medium	Compressed air
Maximum temperature of pressure medium	50 °C
Minimum temperature of pressure medium	-5 °C
Maximum ambient temperature	50 °C
Minimum ambient temperature	-5 °C
Max. Flow rate (l/min (ANR))	300
Max. supply pressure	1.0 MPa
Purge air flow rate (l/min [ANR])	60
Weight	0.780 Kg

Constructions

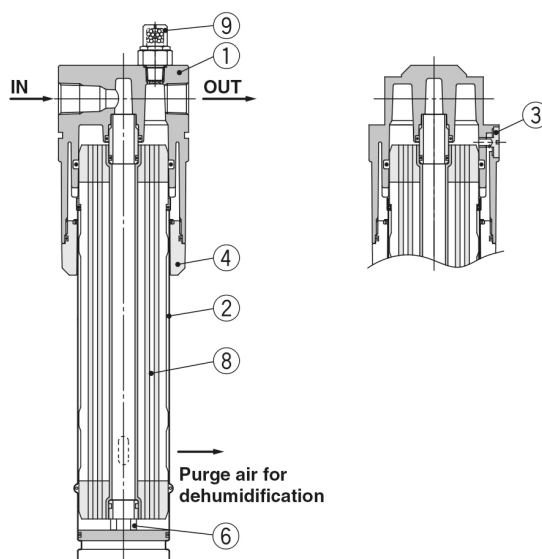

Component Parts

No.	Description	Material							Note
		IDG30□A	IDG50□A	IDG60, 60H*	IDG60LA, 60SA	IDG75, 75H*	IDG75LA, 75SA	IDG100, 100H*	
1	Body	Aluminium alloy/White							*Platinum silver coated
2	Case	Stainless steel							
3	Orifice	Stainless steel							
4	Holder	Aluminium alloy		Aluminium alloy					
5	Silencer	—		Resin + Bronze	Resin	Resin + Bronze	Resin	Resin + Bronze	Resin
6	Adapter	Resin							

Replacement Parts

No.	Description	Part no.							
		IDG30□A	IDG50□A	IDG60, 60H	IDG60LA, 60SA	IDG75, 75H	IDG75LA, 75SA	IDG100, 100H	IDG100LA, 100SA
8	Membrane module kit	IDG-EL30A	IDG-EL50A	IDG-EL60	IDG-EL60LA	IDG-EL75	IDG-EL75LA	IDG-EL100	IDG-EL100LA
		With Nozzle (1 pc.), Adapter (1 pc.), O-ring (1 pc.)			With O-ring (1 pc.)				
9	Dew point indicator kit	IDG-DP01							
10		IDG-DP01-X001 (Semi-standard: P)							

Additional information

Catalogue

[IDG-F_EU.pdf](#)