



C(D)G5-S, Stainless Steel Cylinder, Double Acting, Single Rod CDG5BN20SR-200

Datasheet

General series information

- Double acting, single rod CG5-S cylinder
- All stainless steel external parts
- Special scraper prevents water from entering cylinder
- Bore sizes (mm): 20, 25, 32, 40, 50, 63, 80 and 100
- Auto switch capability



Double-acting, single-rod cylinder

Standard specifications

Magnet	D (Built-in)
Mounting	B (Basic Style)
Style	N (Non-lube Rubber Cushion)
Bore Size	20 mm
Thread	Rc (M5 for Air Cushion 20 & 25 Bore)
Seal Material	R (NBR)
Stroke	200
Auto Switch	None
Lead Wire or Prewired Connector	0.5m (Or None in the Case of No Switch)
Number	2 pcs. (Or None in the Case of No Switch)
Rod End Options	None
Temperature Resistance	None
Pressure medium	Air
Maximum temperature of pressure medium with magnet	60 °C
Minimum temperature of pressure medium with magnet	-10 °C
Maximum operating pressure	1.0 MPa
Minimum operating pressure	0.05 MPa
Proof pressure	1.5 MPa

Maximum ambient temperature with magnet	60 °C
Minimum ambient temperature with magnet	-10 °C
Number of pneumatic connections	2 pcs.
Pneumatic input connection	M5 x 0.8
Mode of operation of drive	Double acting
Maximum piston speed	1000 mm/s
Piston rod end	External thread
Geometric form of the piston rod	Round piston rod
Male thread of rod end	M8 x 1.25
Minimum piston speed	50 mm/s

Dimensions

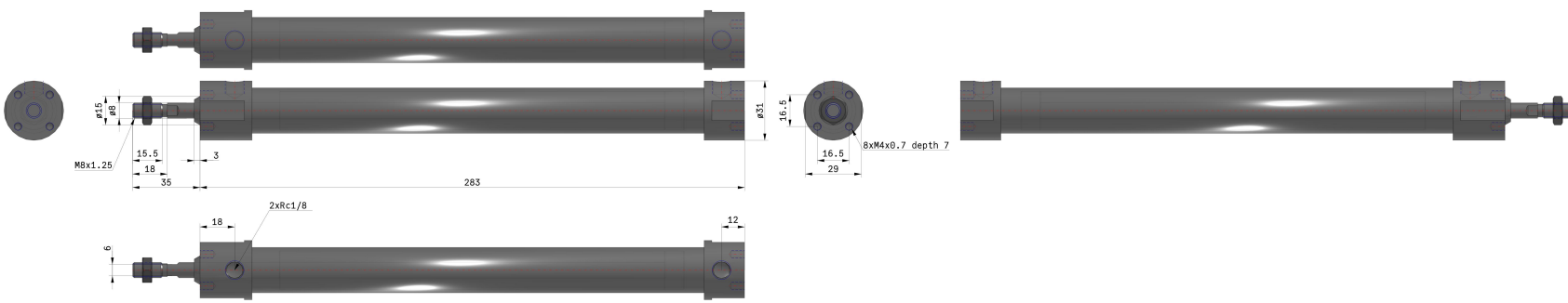

Constructions

Construction

With rubber bumper

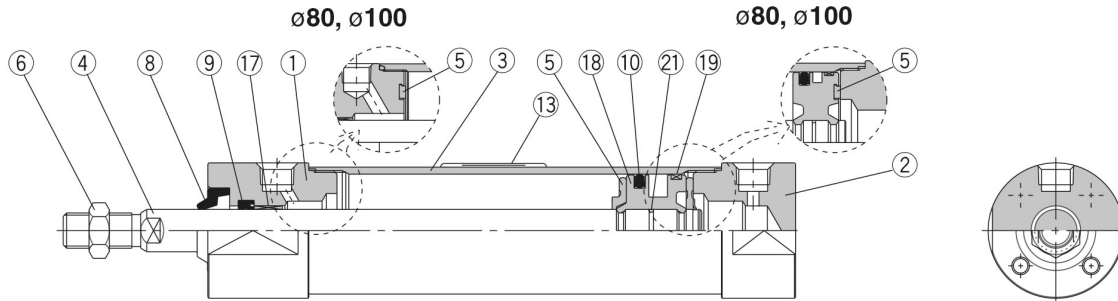

Component Parts

No.	Description	Material
1	Rod cover	Stainless steel 304
2	Head cover	Stainless steel 304
3	Cylinder tube	Stainless steel 304
4	Piston rod	Stainless steel 304 Hard chrome plated
5	Bumper	Urethane
6	Rod end nut	Stainless steel 304
17	Bushing	Bearing alloy
18	Piston	Aluminium alloy
19	Wearing	Resin

No.	Description	Material	
		CG5□□□SR	CG5□□□SV
8	Water resistant scraper	NBR	FKM
9	Rod seal		
10	Piston seal		
21	Piston gasket	PET	
13	Label protector	PET	

Note 1) Component part material and surface treatment other than listed above are the same as the standard type of Series CG1.

Note 2) For cylinders with an auto switch, the piston is fixed with a magnet.

Additional information

Catalogue

[CJ5-CG5-B_EU.pdf](#)