

Standard - MHS3 MHS3-80D

Datasheet

General series information

- Maximum gripping force 1320 N at 0.5 MPa
- Double acting
- Repeatability: ± 0.01 mm
- Max. operating frequency: 120 c.p.m.

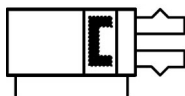

Gripper, internal grip, double-acting with permanent magnet on piston

Standard specifications

Bore Size	80mm
Thread Type	Rc: 80-125 Bore; M Thread 32 to 63 Bore
Auto Switch	No Switch
Lead Wire or Prewired Connector	0.5m (Or None in the Case of No Switch)
Number	2 pcs. (Or None in the Case of No Switch)
Special Specifications	None
Maximum operating pressure	0.6 MPa
Minimum operating pressure	0.1 MPa
Maximum ambient temperature	60 °C
Minimum ambient temperature	-10 °C
Conform to the European RoHS Directive	Conform
Repeatability	± 0.01 mm
Lubrication	Non-Lube
Effective holding force per finger, external (0.5 MPa)	500 N
Effective holding force per finger, internal (0.5 MPa)	525 N
Maximum operating frequency	30 c.p.m.
Opening / closing stroke (both sides)	20 mm
Fluid	Air
Action	Double Acting

Weight

1.850 Kg

Dimensions

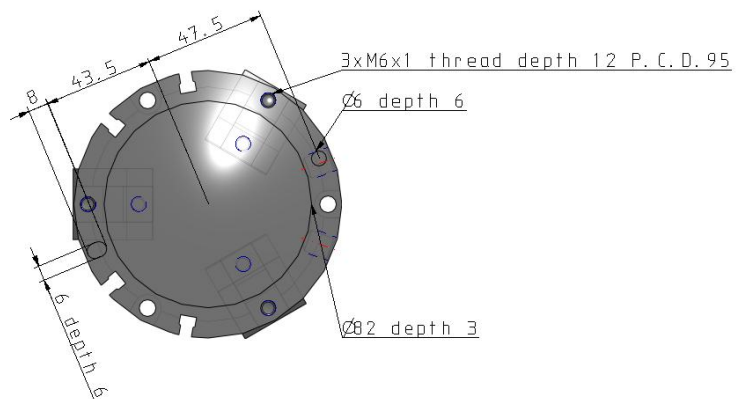
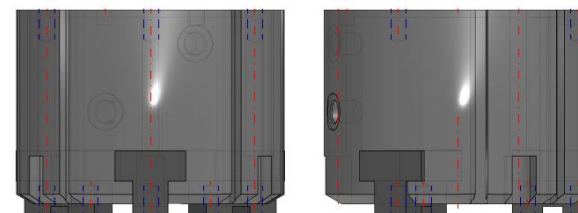
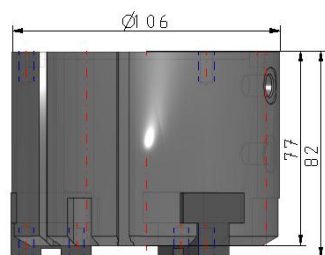
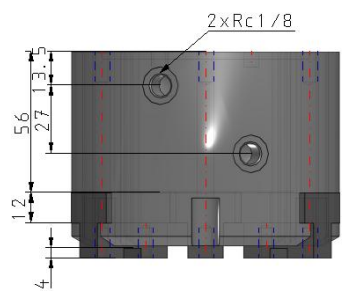
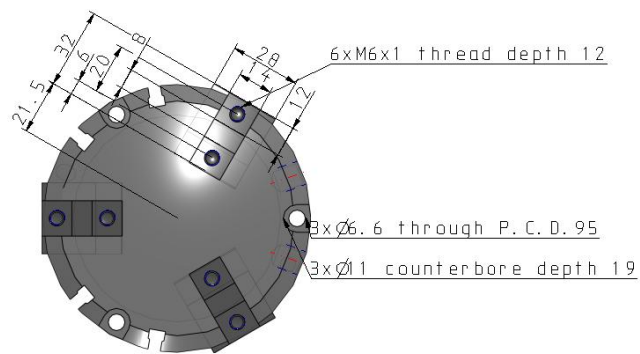

Constructions

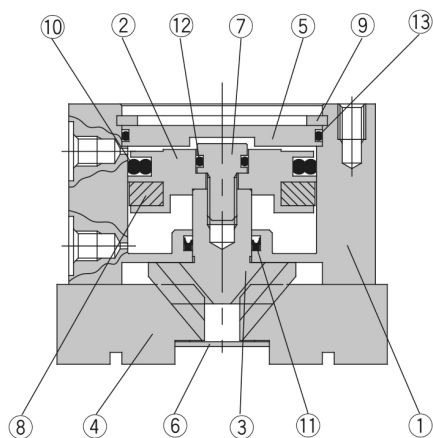
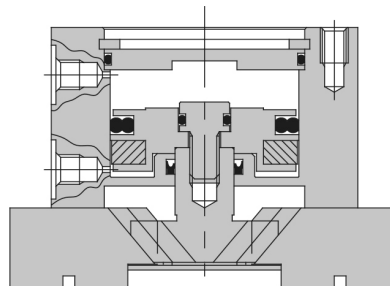
Closed condition

Open condition

Parts list

No.	Description	Material	Note
1	Body	Aluminum alloy	Hard anodized
2	Piston	Aluminum alloy	Hard anodized
3	Cam	Carbon steel	Heat treated, Specially treated
4	Finger	Carbon steel	Heat treated, Specially treated
5	Cap	Aluminum alloy	Hard anodized
6	End plate	Stainless steel	
7	Piston bolt	Stainless steel	

No.	Description	Material	Note
8	Rubber magnet	Synthetic rubber	
9	C type snap ring	Carbon steel	Nickel plated
10	Piston seal	NBR	
11	Rod seal	NBR	
12	Gasket	NBR	
13	Gasket	NBR	

Additional information

Catalogue

[MHS_EU.pdf](#)